



GARAGE

GARAGE

EMERGENZA	832	EMERGENCY
MANUTENZIONE	844	SERVICE
COPRIAUTO	881	CAR COVERS
CAMPER E ROULOTTES	902	MOTORHOME, CARAVAN
PARCHEGGIO	903	PARKING
ANTIFURTI	911	ANTI-THEFT DEVICES
FILTRI CARBURANTE	919	FUEL FILTERS
FILTRI ARIA	920	AIR FILTERS



con bandierina di segnalazione



FLEX 2800 KG
 Corda traino estensibile.
 Omologata GS-TÜV 2500 kg.
 Lunghezza 1,5-4 mt.

FLEX 2800 KG
 Extensible towing rope.
 GS-TÜV approved for 2500 kg.
 Length: 1,5-4 m

60560

Borsina / Bag 10



2500 KG

MAX 2800 KG



con bandierina di segnalazione



MINIFLEX 2100 KG
 Corda traino estensibile
 Omologata GS-TÜV 1450 kg
 Lunghezza 1,5 - 4 mt

MINIFLEX 2100 KG
 Extensible towing rope
 GS-TÜV approved for 1450 kg
 Length: 1,5 - 4 m

60561 Borsina / Bag 10

60562 Busta / PE bag 10



1450 KG

MAX 2100 KG



con bandierina di segnalazione



MASTER, CAVO TRAINO 5000 KG
 Diametro 18 mm - Lunghezza 4 m
MASTER, 5000 KG TOWING ROPE
 Diameter 18 mm - Length 4 m

60567

Borsina / Bag 5 / 20

MAX 5000 KG



con bandierina di segnalazione



CAVO TRAINO IN ACCIAIO
 Cavo plastificato da 3,5 mt.
STEEL TOWING ROPE
 Rope length 3,5 m.
 Plastic coated rope

60581 Ø 6 mm 3000 Kg

60582 Ø 8 mm 5000 kg

Borsina / Bag 10

MAX 3000 KG

MAX 5000 KG



con bandierina di segnalazione



BARRA TRAINO 2000 KG
 Omologata GS-TÜV 1800 kg
 Lunghezza cm 180

TOWING BAR 2000 KG
 GS-TÜV approved 1800 kg
 Length cm 180

60580

Scatola / Box 6



1800 KG

MAX 2000 KG



Prodotto di qualità certificata
Quality product certified by

Premium



www.tuv.com
ID 0000038137



Bundesanstalt für
Materialforschung
und -prüfung



Approved



PREMIUM, TANICA CARBURANTE IN METALLO

- Idonee per qualsiasi tipo di carburante.
- Verniciatura interna ed esterna a polvere epossidica, resistente al carburante.
- Spessore maggiorato (0,9 mm).
- Tappo a vite zigrinato con magnete.
- Ampio canale di sfiato.

PREMIUM, METAL JERRY-CAN

- Suitable for all fuels.
- Internal and external powder epoxy painting, resistant to fuel.
- Body metal thickness (0,9 mm).
- Screw cap with textured surface and incorporated magnet.
- Wide vent channel.



Tappo a vite con magnete
Screw cap with magnet

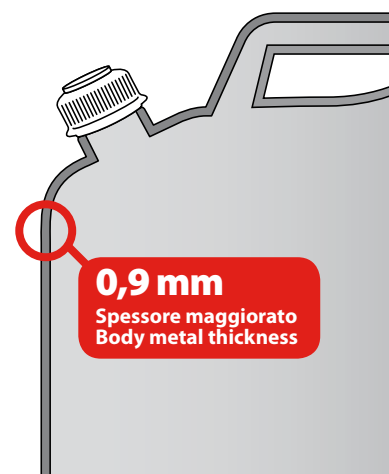

0,9 mm
Spessore maggiorato
Body metal thickness

67008	Rosso	Red	5 L
67009	Nero	Black	
67006	Rosso	Red	10 L
67007	Nero	Black	
67004	Rosso	Red	20 L
67005	Nero	Black	

Sfuso / Bulk 5

BENZINA



Ø 20mm

PREMIUM, TRAVASATORE FLESSIBILE PER BENZINA
Realizzato in metallo con attacco a vite, lunghezza 32 cm.
Indicato per taniche serie "Premium" art. 67004, 67005,
67006, 67007, 67008, 67009

PREMIUM, FLEXIBLE SPOUT FOR PETROL
Made of metal with screw locking tip. Length 32 cm.
Suitable for "Premium" metal jerry-cans art. 67004, 67005,
67006, 67007, 67008, 67009

67018 Ø 20mm

Sacchetto / Bag 25

DIESEL



Ø 25mm

PREMIUM, TRAVASATORE FLESSIBILE PER DIESEL
Realizzato in metallo con attacco a vite, lunghezza 32 cm.
Indicato per taniche serie "Premium" art. 67004, 67005,
67006, 67007, 67008, 67009

PREMIUM, FLEXIBLE SPOUT FOR DIESEL
Made of metal with screw locking tip. Length 32 cm.
Suitable for "Premium" metal jerry-cans art. 67004, 67005,
67006, 67007, 67008, 67009

67019 Ø 25mm

Sacchetto / Bag 25



Approved



5 L

10 L

20 L

Interno smaltato
Inner coating
mod. 5 - 10 L

**TANICA CARBURANTE
TIPO MILITARE IN METALLO
MILITARY METAL JERRY-CANS**

67002	5 L	Sfuso / Bulk	8
67001	10 L	Sfuso / Bulk	5
67000	20 L	Sfuso / Bulk	4

Sfuso / Bulk 4



TRAVASATORE FLESSIBILE

In metallo zincato, lunghezza 28 cm.
Indicato per taniche tipo militare art. 67000 e 67001

METAL FLEXIBLE JERRY-CAN SPOUT

Length 28 cm.
Suitable for art. 67000 and 67001

67020

Sfuso / Bulk 10 / 50



20 L

10 L



Approved

**E10
PROOF**

**IMPILABILI
STACKABLE**

**TANICHE CARBURANTE
IN POLIETILENE, MODELLI MILITARI**

Specifiche NATO, spessore maggiorato, altissima resistenza.

Omologate UN ed ADR/GGVSEB per il trasporto di liquidi infiammabili compreso etanolo ed idonee per tutti i carburanti. Complete di travasatore flessibile integrato all'interno della stessa tanica. Accatstabili per uno stoccaggio intensivo in poco spazio

MILITARY TYPE JERRY CANS

With UN certifications according to ADR/GGVSEB for transporting hazardous goods. Fulfills highest safety requirements, suitable for ethanol fuel. Space-saving and stackable. With integrated spout

66975	10 L	Sfuso / Bulk	5
66976	20 L	Sfuso / Bulk	3



AUTO-STOP

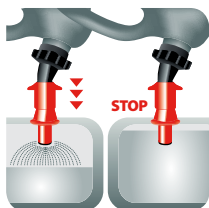

**TRAVASATORE CON SISTEMA
DI PROTEZIONE PER TANICHE**

Specifico per taniche Lampa Art. 66975 - 66976 - 66987 e adatto a taniche con tappo a vite Ø 39 mm, passo 4 mm.

Sistema di arresto automatico del flusso carburante (protezione antitraboccamento). Dotato di valvola di sicurezza per evitare la fuoriuscita del carburante a serbatoio pieno. Ideale per tosaerba e piccole attrezzature.

FILTER NOZZLE FOR FUEL MIX

Safety nozzle with automatic shut off valve for re-fuelling small engines without risk of spilling or escape of vapours. Ideal for re-fuelling chainsaws, lawnmowers, etc.

66979

Busta + Cavaliere / Bag + Header 100



TANICA CARBURANTE COMPLETA DI TRAVASATORE

Omologata a norma UN.
Adatta per tutti i carburanti

JERRY CAN

UN approved, supplied with spout. Suitable for all fuels

66980	5 L	Sfuso / Bulk	18
66981	10 L	Sfuso / Bulk	4
66984	20 L	Sfuso / Bulk	3



TANICA CARBURANTE 2 COMPARTI 5,5+3 L

Specifica per contenere e trasportare 2 diverse tipologie di carburante o lubrificante.

Completa di travasatore

COMBINED JERRY CAN 5,5+3 L

Specific for fuel, fuel mixtures and lubricant. Supplied with spout

66987	5,5+3 L
--------------	---------

Sfuso / Bulk 4



Approved

5,5+3 L



8 L



GIRAFFA, TANICA DI EMERGENZA

Sempre pronta all'uso. Occupa pochissimo spazio, facile e pratica da usare. Riutilizzabile più volte. Con Rapid-Clip autobloccante per una chiusura ermetica

GIRAFFA, EMERGENCY TANK

Always ready for use. Takes minor room and can be stored anywhere. Can be used repeatedly. With quick-seal clip.

66972	8 L
--------------	-----

Busta / Bag 25 / 100



5 L

TANKY, TANICA A SOFFIETTO CON RUBINETTO

FOLDABLE TANK WITH CAP

66970	5 L
--------------	-----

Busta / Bag 10 / 20



8,5 L

TANICA AREA DI SERVIZIO

Doppia maniglia. Foro riempimento Ø 65mm. Foro travaso Ø 14mm

SERVICE AREA SPOUT

Double-Handle. Filling mouth Ø 65mm. Pouring mouth Ø 14mm.

67069 8,5 L

Sfuso / Bulk ☐ 4



TAPPO D'EMERGENZA UNIVERSALE

Si posiziona con una semplice pressione e si toglie sfilandolo.

UNIVERSAL EMERGENCY PETROL CAP

Fits all cars thanks to its extreme flexibility.

67025

D/Blister ☐ 12 / 72



TANICHE IN POLIETILENE USO ALIMENTARE

Omologazione europea per acqua potabile ed alimenti.

- Con imboccatura maxi da Ø 48mm per permettere la pulizia interna.
- Complete di attacco filettato per l'inserimento del rubinetto in plastica.
- Rubinetto in plastica fornito in dotazione ed alloggiato nell'apposito comparto ricavato nella stessa tanica.
- Accatastabili per uno stoccaggio intensivo in poco spazio.

JERRY CANS MADE OF FOOD-SAFE POLYETHYLENE

European-Approved for drinking water.

- 48mm Ø extra-wide mouth for easy inside cleaning.
- Equipped with threaded tap connector.
- Plastic tap included and stored in its lodgement inside the can.
- Stackable for an intensive storage within a limited space

66977 10 L Sfuso / Bulk ☐ 5

66978 20 L Sfuso / Bulk ☐ 3



20 L

10 L



IMPILABILI STACKABLE



Prodotto in conformità alla Nota ministeriale su Regolamento U.E.

According to **EU NORM** n. 10/2011 + 1935/2004



PATROL - PALA D'EMERGENZA TIPO MILITARE
in acciaio, pieghevole in 3 sezioni, completa di custodia.
PATROL - MILITARY STYLE FOLDABLE SHOVEL
3 sections foldable, supplied with pouch.

71000 58 cm

Busta / Bag 12



PALA DA NEVE, COMPONIBILE
Prodotta in alluminio e ABS antiurto.
SNOW-SHOVEL, 3 SECTIONS
Impact resistant plastic. Aluminium handle

71001 91 cm

Scatola / Box 4



PALA DA NEVE, CON MANICO IN ALLUMINIO

- Pala in polipropilene cm 37, a cucchiaio
- Con manico e profilo in alluminio.
- Pratica Impugnatura ergonomica in gomma-spugna

SNOW SHOVEL

- Large plastic hilt, cm 37
- Strong but light tubular aluminium handle.
- Hardwearing plastic blade.
- Anti-skidding rubber-foam grip.
- Aluminium edge strip

71002 145 cm

Sfuso / Bulk 25



Categoria 2
Classe 2

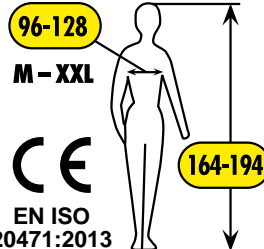

CE
EN ISO 20471:2013
+ DPI(PPE) 425/2016

LIFE-VEST, VESTE RIFLETTENTE
Misura unica universale M-XXL Omologata.

LIFE-VEST
CE approved, universal size M-XXL

65855	Arancio	Amber
65856	Giallo	Yellow

Busta / Bag 5 / 50



**TRIANGOLO BASIK,
AUTO FERMA**
Con piedistallo a croce.
Conforme a norma
Europea ECE R27

TRIANGLE BASIK
Cross base. According to
ECE R27 regulations

65798

Scatola Plast. / Box 5 / 30

(E) R27



445 gr

**TRIANGOLO COMPACT,
AUTO FERMA**
Con piedistallo a ragno.
Conforme a norma
Europea ECE R27

COMPACT TRIANGLE
Spider base. According to
ECE R27 regulations

65799

Scatola Plast. / Box 5 / 40

(E) R27



305 gr

**TRIANGOLO AUTO FERMA
PIEDISTALLO A RAGNO**
Modello "pocket" con valigetta rigida.
Conforme alla norma Europea ECE R27

WARNING TRIANGLE SPIDER BASE
"Pocket" model with case.
According to ECE R27 regulations

65797

Scatola Plast. / Box 5 / 20

Pocket



3

(E) R27



17 LED

**LAMPADA SUPPLEMENTARE
DI EMERGENZA A 17 LED**

Per segnalare situazioni di emergenza,
in caso di incidente o di auto in panne.
Magnetica, resistente agli urti,
impermeabile e galleggiante.
5 differenti funzioni di luce selezionabili.
Richiede 2 batterie AAA (non incluse)

65854 Ø 150 mm

D/Blister 10 / 100

EMERGENCY LIGHT, 17 LEDs

Specific for signalling emergency
situations, car accidents or
breakdowns.
Magnetic, impact resistant.
Floating and waterproof.
Batteries not included (2xAAA).
5 different selectable light
functions



Kombi Set

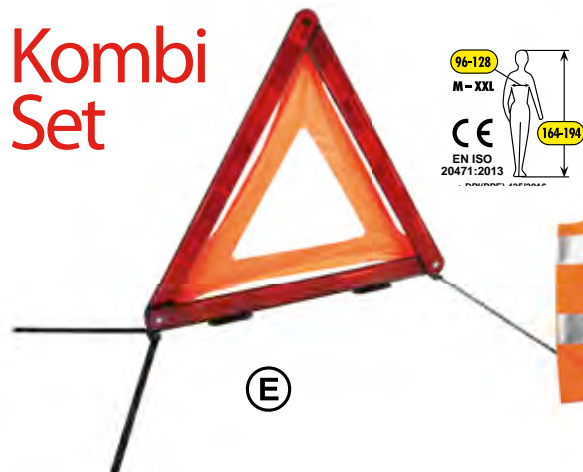

KOMBI SET 3 IN 1, KIT EMERGENZA E SOCCORSO

Contiene:

- Triangolo emergenza (E 27R)
- Veste riflettente (EN ISO 20471:2013)
- Kit pronto soccorso (DIN 13164 - 2014)

KOMBI SET 3 IN 1, EMERGENCY AND FIRST AID KIT

Contents:

- Warning triangle (E 27R)
- Life Vest (EN ISO 20471:2013)
- First aid kit (DIN 13164 - 2014)

66966

Valigetta / Case 10

- | | |
|---------------------------------------|------------------------------------|
| 1 Rotolo di cerotto 2,5 x 500 cm. | 1 Adhesive tape 2.5 x 500 cm. |
| 14 cerotti (misure assortite) | 14 Plasters (assorted sizes) |
| 1 Rotolo di garza sterile, 6 x 8 cm | 1 Sterile roller gauze, 6 x 8 cm |
| 2 Rotoli di garze sterili, 8 x 10 cm | 2 Sterile roller gauzes, 8 x 10 cm |
| 1 Rotolo di garza sterile, 10 x 12 cm | 1 Sterile roller gauze, 10 x 12 cm |
| 1 Benda per ustioni, 40 x 60 cm | 1 Burn dressing, 40 x 60 cm |
| 1 Benda per ustioni, 60 x 80 cm | 1 Burn dressing, 60 x 80 cm |
| 2 Bende elastiche, 6 x 400 cm | 2 Elastic bandages, 6 x 400 cm |
| 3 Bende elastiche, 8 x 400 cm | 3 Elastic bandages, 8 x 400 cm |
| 1 Coperta isoterma oro/argento | 1 Gold / silver isothermal blanket |
| 6 Compresse sterili, 10 x 10 cm | 6 Wound dressings, 10 x 10 cm |
| 2 Bende triangolari | 2 Triangular bandages |
| 1 Paio di forbici taglia bendaggi | 1 Pair of scissors |
| 4 Guanti usa e getta | 4 Disposable gloves |
| 2 Salviette umidificate | 2 Wet wipes |
| 1 Manuale di primo soccorso | 1 First aid manual |



DIN 13164 - 2014



First Aid Kit

FIRST-AID KIT

Kit pronto soccorso per auto e furgoni
conforme alla norma europea
DIN 13164 - 2014

FIRST-AID KIT

For car and van.
DIN 13164 - 2014

- | | |
|----------------------------------|---------------------------------|
| 1 rotolo cerotto, 500 x 2,5 cm. | 1 adhesive tape, 500 x 2,5 cm |
| 14 cerotti (misure assortite) | 14 plasters (assorted sizes) |
| 4 rotoli di garze sterili | 4 sterile roller gauzes |
| 1 benda per ustioni, 40 x 60 cm | 1 burn dressing, 40 x 60 cm |
| 1 benda per ustioni, 60 x 80 cm | 1 burn dressing, 60 x 80 cm |
| 2 bende elastiche, 6 x 4 cm | 2 elastic bandages, 6 x 4 cm |
| 3 bende elastiche, 8 x 4 cm | 3 elastic bandages, 8 x 4 cm |
| 1 copertura isoterma oro/argento | 1 emergency blanket |
| 6 compresse sterili, 10 x 10 cm | 6 wound dressings, 10 x 10 cm |
| 2 bende triangolari | 2 triangular bandages |
| 1 paio di forbici tagliabandaggi | 1 pair of first aid scissors |
| 4 guanti usa e getta | 4 disposable gloves |
| 2 salviette umidificate | 2 wet wipes |
| 1 manuale di primo soccorso | 1 first aid instruction booklet |



66963 Valigetta / Case 10



66962 Busta nylon / Pouch 10



DIN 13164 - 2014

Basic

BASIC, KIT PRONTO SOCCORSO

BASIC, FIRST AID KIT

66965

Valigetta / Case 40

- | | |
|---|---|
| 1 Manuale | 1 Manual |
| 1 Pacchetto fazzoletti da 9 pezzi | 1 Pack of 9 pieces of tissues |
| 1 Sacchetto con 10 cerotti 7x2 cm | 1 Bag with 10 patches 7x2 cm |
| 2 Salviettine umidificate | 2 Wet wipes |
| 1 Paio di guanti | 1 Pair of gloves |
| 1 Garza 5x200 cm | 1 Gauze 5x200 cm |
| 2 Confezioni (da 2 pz) garze sterili 10x10 cm | 2 Packs (x2 pcs) sterile gauze 10x10 cm |
| 1 Benda sterile 40x60 cm | 1 Sterile bandage 40x60 cm |





Testata ed approvata secondo la norma Europea
DIN EN 1869:2001 (EN 1869:1997)

COPERTA IGNIFUGA SPEGNIFUOCO
Sempre utile per la propria e altrui sicurezza.
Da tenere in auto, camper, camion, oppure
in garage, uffici, casa...
Realizzata in fibra di vetro.
Prodotto monouso.

FIRE-BLANKET

This fire blanket is suitable for car, caravan,
truck, garage, office, household kitchens,
home uses. Essential for yours and others
safety. Made of glass fiber.
For single use only, discard after use

68065	100x100 cm
68066	120x180 cm

Busta con cavaliere / Header card 10



COPERTA ISOTERMICA ORO/ARGENTO

Foglio in polietilene tereftalato metallizzato. Riflette il 90% dei raggi
infrarossi. Assicura protezione dal freddo e dal caldo. Se posizionata
con il lato argentato a contatto con il corpo conserva circa l'80%
del calore. Se posizionata con il lato dorato riflette i raggi del sole e
permette al corpo di rimanere fresco.

RESCUE BLANKET

Rescue blanket with a very strong and waterproof metallized
polyethylene terephthalate film. The emergency blanket is designed
to reflect heat back to body or deflect heat when used as a shelter
from the sun. Prevents post accident shock by retaining the patients
body heat. The silver side protects the body from the heat, the gold
side protects the body from the cold. Reflects 90% of the infrared
radiations. Protects from cold, heat, rain, dampness and wind.

66964	160x210 cm
--------------	------------

Busta / Bag 10 / 200

Estintori



1 KG



ESTINTORE KG 1
Omologato 84 - 34B - C
FIRE EXTINGUISHER KG 1
Homologation: 8A - 34B - C

68056	1 Kg
--------------	------

Scatola / Box 6



2 KG



ESTINTORE KG 2
Omologato 13A - 89B - C
FIRE EXTINGUISHER KG 2
Homologation: 13A - 89B - C

68057	2 Kg
--------------	------

Scatola / Box 4

ESCAPE, PORTACHIAVE SALVAVITA 3 IN 1

Indispensabile per liberarsi ed uscire dal veicolo in caso di incidente.

- Dispositivo rompivetro a rilascio automatico.
- Lama tagliacintura di sicurezza.
- Anello portachiavi

3 IN 1 ESCAPE TOOL

Life-saving tool to escape from vehicle in case of accident.

- Window smashing tool.
- Safety belt cutter.
- Key fob

65045

D/Blister 10 / 100



Escape



Punta in Metallo
Metal Tip

3 in 1



Martello automatico, rompe il vetro in modo sicuro, semplicemente premendo verso l'esterno.

Automatic safety hammer shatter the car's side and / or rear window easily.



Lama tagliacintura integrata
Integrated blade for cut seatbelt



Pratico anello portachiavi con sgancio rapido
Keyring with quick release



L'ORIGINALE



MADE IN USA



Type Approval
Safety
Regular Production
Surveillance
www.tuv.com
ID: 200000000

Colori Assortiti
Assorted Colours



Acciaio inox
Stainless steel

RESQME, MARTELLO SALVAVITA

Questo strumento "2 in 1", consente di tagliare una cintura di sicurezza bloccata e di rompere il finestrino laterale della propria auto. Originariamente sviluppato per il primo soccorso (vigili del fuoco e le forze dell'ordine), il resqme è diventato la soluzione di sicurezza essenziale per tutti i conducenti responsabili. Rompe i finestrini laterali dell'auto, taglia la cintura di sicurezza nel caso sia bloccata. Compatto, leggero e potente. Rende più semplice la via di fuga dall'auto.

RESQME, SAFETY HAMMER

This 2 in 1, allows you to cut a jammed seatbelt and to break a side window in your car. Originally developed for first responders (firefighters EMTs, law enforcement agencies), resqme has become essential safety solution for all safety-conscious drivers. Breaks car side windows, cut jammed seatbelt. Compact, lightweight and powerful. This is the most affordable and reliable car escape too.

RQM12010008

Blister 12 / 192



Martello automatico, rompe il vetro in modo sicuro, semplicemente premendo verso l'esterno.

Automatic safety hammer shatter the car's side and / or rear window easily.



Lama tagliacintura integrata
Integrated blade for cut seatbelt



Pratico anello portachiavi con sgancio rapido
Keyring with quick release

LIFE-HAMMER, MARTELLLO SALVAVITA CLASSICO

Martello rompivetro a doppia punta, completo di lama tagliacintura. Omologato TÜV. Supporto con fissaggio fisso a viti oppure alla moquette tramite aghi estraibili

LIFE-HAMMER, SAFETY HAMMER CLASSIC

Double sided hammerhead, included seat belt cutter. TÜV certified. Fixing base with screws or with needles

LHCGY001T2	Giallo Yellow	Scatola / Box 18
74131	Arancio Orange	Blister 12



Fissaggio con aghi
Mounting with needles



Fissaggio con viti
Mounting with screws



LIFE-HAMMER

N°1 CAR SAFETY EXPERTS

CLASSIC



LIFE-HAMMER PLUS, MARTELLLO SALVAVITA

Martello rompivetro a doppia punta in acciaio al carbonio, completo di lama tagliacintura. Omologato TÜV. Staffa di fissaggio per la portiera dell'auto con sistema di sgancio rapido

LIFE-HAMMER PLUS, SAFETY HAMMER

Double sided carbon steel hammerhead, included seat belt cutter. TÜV certified. Clamp fastener for car door. Quick click system

LHPBL001T2

Scatola / Box 12



Staffa di fissaggio per la portiera dell'auto



Clamp fastener for car door Quick Click System



LIFE-HAMMER

N°1 CAR SAFETY EXPERTS

PLUS



LIFE-HAMMER EVOLUTION, MARTELLLO SALVAVITA

Martello di sicurezza automatico, omologato TÜV. Rompe il finestrino in modo rapido e sicuro con una semplice pressione sul vetro. Testa del martello in ceramica ultra resistente, completo di lama tagliacintura. Staffa di fissaggio rotante per la portiera dell'auto con sistema di sgancio rapido

LIFE-HAMMER EVOLUTION, SAFETY HAMMER

Automatic safety hammer, TÜV certified. Simply press the hammer against the car's window. The ceramic hammerhead will shatter the window automatically. Easy and safe to use. Clamp fastener for car door. Quick click system

LHEBL001T2

Scatola / Box 12



Martello automatico, rompe il vetro in modo sicuro, semplicemente premendo verso l'esterno. Automatic safety hammer. German standards shatter the car's side and/or rear window easily.



Staffa di fissaggio per la portiera dell'auto
Clamp fastener for car door Quick Click System



LIFE-HAMMER

N°1 CAR SAFETY EXPERTS

EVOLUTION



Punta in ceramica
Ceramic tip

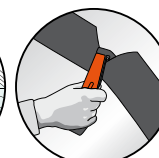
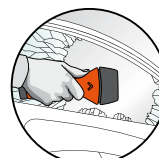



**Omologato
Homologated**



RESCUE, MARTELLLO D'EMERGENZA
Martello frangi-cristalli con supporto
RESCUE, EMERGENCY HAMMER
Supplied with holder

74129

D/Blister 10 / 50



MARTELLLO EMERGENCY
Martello frangi-cristalli con
lama tagliacintura
EMERGENCY HAMMER
With seat belt cutter

48070

D/Blister 10 / 100



**AVVISATORE ACUSTICO
D'EMERGENZA A GAS**
Kit composto da: tromba e
bomboletta con gas

HAND HORN KIT
Horn and gas can kit

42000

D/Blister 10

**BOMBOLA GAS RICAMBIO
GAS CAN REFILL**

42001

Sfuso / Bulk 24



Antiaggressione

150 ml



**Display
12 pcs**

SPRAY ANTIAGGRESSIONE AL PEPERONCINO

L'unico prodotto legale e made in Germany conforme al Decreto Ministeriale n°103 - 2011.

- Getto a nuvola portata 1/3 metri.
- Non infiammabile.
- Dispositivo di sicurezza contro l'attivazione accidentale.
- Non reca danni permanenti ma immobilizza l'aggressore per 30 minuti.
- Contiene solo Oleoresin Capsicum.
- Libera vendita ai maggiori di anni 16

ANTI-AGGRESSION PEPPER SPRAY

Made in Germany in accordance to the D.M. n°103 - 2011.

- Cloud spray with an effective range of 1-3 meters.
- Non-combustible base.
- Security lock to prevent accidental activation.
- The spray does not cause injuries, but stops the attacker and provides the user with time to safely leave the area.
- The spray can stop the attacker for 30 minutes or more.
- Contains only Oleoresin Capsicum.
- Free sale to anyone over 16 years old.

66955

1 pz

D/Blister 12

66955D

Display 12 pz

Scatola / Box 1





VINYL

XL
EXTRA
LARGE**GUANTI IN VINILE**

Monouso, ambidestro, non-sterili, senza polvere lubrificante, con bordino. Prodotto in polivinilcloruro, ad elevata bio-compatibilità, esente da lattice di gomma naturale.

VINYL GLOVES

Disposable, ambidextrous, non-sterile, powder free and with trim. Latex-free.

71398	Dispenser 100 pz	Box	10
--------------	------------------	-----	----

71399	Dispenser 20 pz	Box	10 / 50
--------------	-----------------	-----	---------



EN 420 / 06.94
EN 455 - 1:2000
EN 455 - 2:2000
EN 455 - 3:1999

Categoria di rischio solo per rischi minori. Idoneo al contatto breve con alimenti.

VINYL
STRETCHXL
EXTRA
LARGE**GUANTI IN VINILE SINTETICO ELASTICIZZATO**

Monouso, ambidestro, non-sterili, senza polvere lubrificante, con bordino. Prodotto in polivinilcloruro, ad elevata bio-compatibilità, esente da lattice di gomma naturale.

SYNTHETIC ELASTICIZED VINYL GLOVES

Disposable, ambidextrous, non-sterile, powder free and with trim. Latex-free.

71392	Dispenser 100 pz	Box	10
--------------	------------------	-----	----

71393	Dispenser 20 pz	Box	10 / 50
--------------	-----------------	-----	---------



EN 420 / 06.94
EN 455 - 1:2000
EN 455 - 2:2000
EN 455 - 3:1999

Categoria di rischio solo per rischi minori. Idoneo al contatto breve con alimenti.



NITRILE

XL
EXTRA
LARGE**GUANTI IN NITRILE**

Elevata sensibilità, destrezza e confort. Resistenza chimica a detersivi e detergenti, anche concentrati, idrocarburi, solventi, eteri e freon. Buona resistenza meccanica, superiore al guanto monouso in lattice o vinile. Elevata bio-compatibilità, esente da lattice di gomma naturale.

NITRILE GLOVES

Disposable, ambidextrous, non-sterile, powder free and with trim. Latex-free.

71407	Dispenser 100 pz	Box	10
--------------	------------------	-----	----

71409	Dispenser 20 pz	Box	10 / 50
--------------	-----------------	-----	---------



EN 420 / 06.94
EN 455 - 1:2000
EN 455 - 2:2000
EN 455 - 3:1999

Categoria di rischio solo per rischi minori. Idoneo al contatto breve con alimenti.



HPDE

XL
EXTRA
LARGE**JOLLY MULTI-USO**

Guanti usa e getta, in polietilene, ambidestri.

JOLLY MULTI-USE

Disposable PE gloves.

71404	20 pz	Cavaliere	50
--------------	-------	-----------	----

71403	100 pz (dispenser)	Box	100
--------------	--------------------	-----	-----

PELLE
NATURALE
NATURAL
LEATHER**GUANTI LAVORO IN PELLE
REAL LEATHER WORKING GLOVES**

71400	9	Taglia / Size
71401	10	Taglia / Size

Cavaliere / Header	10 / 60
--------------------	---------



EN 388
4133

EN388:2016
EN420:2003+A1:2009
DPI (PPE) 2016/425





**PELLE
 NATURALE
 NATURAL
 LEATHER**

GUANTI IN PELLE FIORE DI MAIALINO

Guanti in pelle di maialino con polsino elasticizzato e chiusura a velcro. Dorso 100% in cotone. Ottima aderenza, sensibilità e morbidezza, ideali per la conduzione di automezzi, carico e scarico merci, settore agricolo, meccanico, metalmeccanico, lavori di precisione... Omologazioni: CE EN 388 - EN 420

PIG GRAIN LEATHER GLOVES

Pig grain gloves with elastic wrist and velcro closure. 100% cotton back. Perfect adherence, comfortable and soft, suitable for driving motor vehicles, loading and unloading cartons, agricultural and mechanical field, precision works... Approval: CE EN 388 - EN 420

71368	9	Taglia / Size
71369	10	

Cavaliere / Header 12 / 120



**PELLE
 NATURALE
 NATURAL
 LEATHER**

GUANTI IN PELLE FIORE DI VITELLO

Guanti in pelle di vitello con bordino. Spessore della pelle: 1,1-1,30 mm. Ottima aderenza, sensibilità e morbidezza, ideali per la conduzione di automezzi, carico e scarico merci, settore agricolo, meccanico, metalmeccanico... Omologazioni: CE EN 388 - EN 420

COW GRAIN WHITE LEATHER WORKING GLOVES

Cow grain leather gloves with trim. Thickness of leather: 1,1-1,30 mm. Perfect adherence, comfortable and soft, suitable for driving motor vehicles, loading and unloading cartons, agricultural and mechanical field... Approval: CE EN 388 - EN 420

71428	9	Taglia / Size
71429	10	

Cavaliere / Header 10 / 60

**EN388:2016
 EN420:2003+A1:2009
 DPI (PPE) 2016/425**



**PELLE
 NATURALE
 NATURAL
 LEATHER**

GUANTI IN PELLE DI CAPRA

Guanti in pelle di capra con polsino elasticizzato e chiusura a velcro. Dorso 100% in cotone. Ottima aderenza, sensibilità e morbidezza, ideali per la conduzione di automezzi, carico e scarico merci, settore agricolo, meccanico, metalmeccanico, lavori di precisione... Omologazioni: CE EN 388 - EN 420

GOAT SKIN WHITE LEATHER WORKING GLOVES

Goat gloves with elastic wrist and velcro closure. 100% cotton back. Perfect adherence, comfortable and soft, suitable for driving motor vehicles, loading and unloading cartons, agricultural and mechanical field, precision works... Approval: CE EN 388 - EN 420

71432	9	Taglia / Size
71433	10	

Cavaliere / Header 10 / 100

**EN388:2016
 EN420:2003+A1:2009
 DPI (PPE) 2016/425**



**FELPATO
 INTERNAMENTE
 PLUSH-LINED**

**PELLE
 NATURALE
 NATURAL
 LEATHER**

GUANTI IN PELLE FIORE DI BUFALO

Guanti in pelle fiore di bufalo orlato, felpato internamente. Spessore della pelle: 1,0-1,30 mm. Ottima aderenza, sensibilità e morbidezza, ideali per la conduzione di automezzi, carico e scarico merci, settore agricolo, meccanico, metalmeccanico... Omologazioni: CE EN 388 - EN 420

WHITE BUFFALO LEATHER WORKING GLOVES

White buffalo gloves bordered with internal lining. Thickness of leather: 1-1,3 mm. Perfect adherence, comfortable and soft, suitable for driving motor vehicles, loading and unloading cartons, agricultural and mechanical field... Approval: CE EN 388 - EN 420

71444	9	Taglia / Size
71445	10	

Cavaliere / Header 10 / 100

**EN388:2016
 EN420:2003+A1:2009
 DPI (PPE) 2016/425**



**PELLE
 NATURALE
 NATURAL
 LEATHER**

GUANTI IN PELLE FIORE E CROSTA DI VITELLO

Guanti in pelle di capra con polsino elasticizzato e chiusura a velcro. Dorso 100% in cotone. Ottima aderenza, sensibilità e morbidezza, ideali per la conduzione di automezzi, carico e scarico merci, settore agricolo, meccanico, metalmeccanico... Omologazioni: CE EN 388 - EN 420

WHITE COW LEATHER + SPLIT LEATHER BACK WORKING GLOVES

White cow leather and split leather at the back. With trim. Thickness of leather: 1,10-1,30 mm. Perfect adherence, comfortable and soft, suitable for driving motor vehicles, loading and unloading cartons, agricultural and mechanical field... Approval: CE EN 388 - EN 420

71440	9	Taglia / Size
71441	10	

Cavaliere / Header 10 / 60

**EN388:2016
 EN420:2003+A1:2009
 DPI (PPE) 2016/425**





 PELLE
NATURALE
NATURAL
LEATHER
GUANTI IN PELLE DI BOVINO CON BORDINO

Spessore della pelle: 1,0 - 1,1 mm. Ottima aderenza, sensibilità e morbidezza, ideali per la conduzione di automezzi, carico e scarico merci, settore agricolo, meccanico, metalmeccanico...

COW GRAIN LEATHER

Thickness of leather: 1,0 - 1,1 mm. Perfect adherence, comfortable and soft, suitable for driving motor vehicles, loading and unloading cartons, agricultural and mechanical field...

71448	9	Taglia / Size
71449	10	

Cavaliere / Header  10 / 60**GUANTI IN POLIURETANO**

Guanti in filato elastico con palmo ricoperto in poliuretano. Ottima aderenza, sensibilità e morbidezza, ideali per la conduzione di automezzi, carico e scarico merci, settore agricolo, meccanico, metalmeccanico, lavori di precisione... Omologazioni: CE EN 388 - EN 420

POLYURETHANE GLOVES

Elastic gloves with polyurethane coated palm. Perfect adherence, comfortable and soft, suitable for driving motor vehicles, loading and unloading cartons, agricultural and mechanical field, precision works... Approval: CE EN 388 - EN 420

71372	9	Taglia / Size
71373	10	

Cavaliere / Header  12 / 240**GUANTI IN NITRILE**

Guanti con palmo ricoperto in nitrile, supporto a filo continuo, senza cuciture. Ottima aderenza, sensibilità e morbidezza, ideali per la conduzione di automezzi, carico e scarico merci, settore agricolo, meccanico, metalmeccanico, lavori di precisione... Omologazioni: CE EN 388 - EN 420

NITRILE GLOVES

Gloves with nitrile coated palm, seamless support, no stitching. Perfect adherence, comfortable and soft, suitable for driving motor vehicles, loading and unloading cartons, agricultural and mechanical field, precision works... Approval: CE EN 388 - EN 420

71376	9	Taglia / Size
71377	10	

Cavaliere / Header  12 / 240**GUANTI IN NITRILE HEAVY-DUTY**

Guanti con palmo e dorso ricoperti in nitrile, manicotto in tela. Omologazioni: CE EN 388 - EN 420

HEAVY DUTY NITRILE GLOVES

Heavy duty gloves with coated palm and back, cotton cuff. Approval: CE EN 388 - EN 420

71380	9	Taglia / Size
71381	10	

Cavaliere / Header  12 / 120**GUANTI IN LATTICE**

Guanti con palmo ricoperto in lattice, supporto a filo continuo, senza cuciture. Ottima aderenza, sensibilità e morbidezza, ideali per carico e scarico merci, lavori agricoli, meccanici, di precisione... Omologazioni: CE EN 388 - EN 420

LATEX GLOVES

Gloves with latex coated palm, seamless support, no stitching. Perfect adherence, comfortable and soft, suitable for loading and unloading cartons, agricultural and mechanical field, precision works... Approval: CE EN 388 - EN 420

71384	9	Taglia / Size
71385	10	

Cavaliere / Header  12 / 120

SET IMBUTI 4 PEZZI

Assortiti nei diametri:
50-75-100-120 mm.

SET OF 4 FUNNELS

Assorted in diameters:
50-75-100-120 mm.

67031

Sfuso / Bulk ☐ 12 / 72



**TRAVASATORE GRADUATO
RED GRADUATED CANS
WITH SPOUT**

67061	1000 ml	☐ 15
67063	3000 ml	☐ 4

Sfuso / Bulk



POMPETTA A SIFONE

Multiuso per travasare
qualsiasi liquido.

MULTIUSE SYPHON PUMP

38121 180 cm - Ø 3 mm

Cavaliere / Header ☐ 12 / 72

POMPA A SIFONE PROFESSIONALE

Tubo 180 cm. Resistente alla benzina
ed ai prodotti chimici.

**PROFESSIONAL RUBBER SYPHON
PUMP**

For gas and all liquids. 180 cm tube

38123 180 cm - Ø 3 mm

D/Blister ☐ 12 / 72



IMBUTO TRAVASATORE

Diametro 160 mm, con
tubo flessibile asportabile
e filtrino in acciaio.

FLEXIBLE FUNNEL

With removable flexible
hose and steel filter.
Diameter: 160 mm.

67030

Sfuso / Bulk ☐ 10 / 50



CARAFFA GRADUATA

Trasparente

GRADUATED CAN

Transparent

67053	3000 ml	Sfuso / Bulk ☐ 10
67051	1000 ml	Sfuso / Bulk ☐ 12
67054	250 ml	Sfuso / Bulk ☐ 25
67052	100 ml	Sfuso / Bulk ☐ 10 / 250

EXTRACTOR, POMPA ASPIRAZIONE OLIO E LIQUIDI, 18 L

Progettata appositamente per l'estrazione di oli e liquidi vari da auto, moto, barche, camion, mezzi agricoli e macchinari industriali. Idonea anche per l'aspirazione di carburanti ed altri liquidi non corrosivi per la plastica.

EXTRACTOR, PUMP FOR EXTRACT OIL AND LIQUIDS, 18 L

It is designed for extracting all types of engine, transmission and lubricating oils from cars, motorcycles, marine engines, stationary engines, trucks, RV's, lawn mowers, agricultural vehicles and industrial machineries. Suitable for siphoning all kinds of non corrosive liquids.

72134

Scatola / Box 1



Impugnatura antiscivolo
Anti-slip handle

Sfiato aria
Blow hole

18 L

MANUALE
MANUAL

Extractor



Ingresso / scarico liquidi
Oil inlet/outlet

Con tappo di chiusura
Cap

Porta tubi secondari
Tubing set holder

Blocco ruote
Casters with caster lock

Tubi aspirazione / Tubing set:
Ø 9,8 - 6,7 - 5,8 mm

Maniglia per il traino
Pulling handle



12V

POMPA ASPIRAOLIO 12V
Il sistema più pratico, pulito ed ecologico per il cambio d'olio
OIL EXTRACTOR PUMP 12V

72163

Scatola / Box 10





6,5 L

POMPA ASPIRALIQUIDI TRAVASO A BIDONE
 Max. 6,5 litri. Indicata per il cambio olio.
 Con raccordi in varie misure.
VACUUM CANISTER, OIL EXTRACTOR
 Max 6,5 litres. Complete with adapters and hoses.

72162

Scatola / Box 4



12V

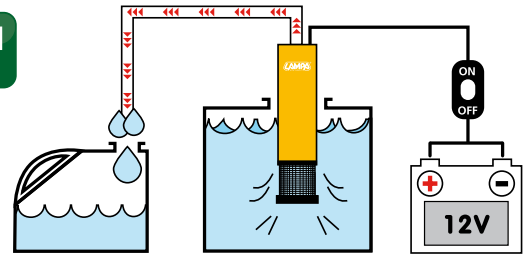

POMPA ASPIRA LIQUIDI ELETTRICA AD IMMERSIONE, 12V

- Collegamento con clip batteria.
- Filtro rimovibile e lavabile.
- Scocca in alluminio.
- Interruttore on /off
- Cavo da 3 metri

ELECTRICAL IMMERSION PUMP, 12V

- Connection to battery through cable clips.
- Removable and washable external filter.
- Aluminium body.
- On /off switch
- 3 meters cable

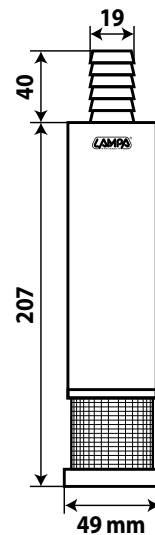

30 l/min
 8500 rpm/min

72158 Standard

Scatola / Box 20

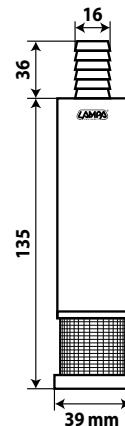

12 l/min
 8500 rpm/min

72169 Compact

Scatola / Box 40



ATTENZIONE WARNING

Da utilizzarsi esclusivamente per aspirare liquidi non infiammabili (diesel, acqua, vino, olio,...). Non utilizzare per aspirare liquidi infiammabili (benzine, kerosene, alcool,...). Pericolo di esplosione ed incendio. Si declina ogni responsabilità per un utilizzo improprio.

To be used solely for pumping non flammable liquids (diesel, water, wine, oil,...). Do not use for pumping inflammable liquids (gasoline, alcohol, kerosene,...). Danger of explosions and fire. We accept no responsibility for improper use.

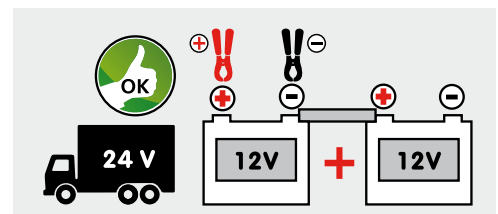
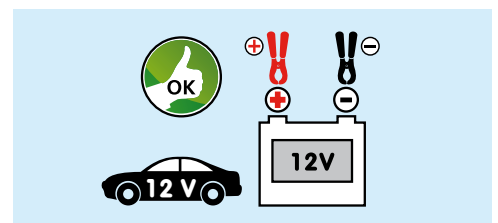

CHIAVE SVITACANDELE SNODABILE
Lunghezza manico cm 15.
SPARK PLUG T-HANDLE WRENCH
Handle length cm 15.

65870	16 mm	D/Blister	10 / 60
65879	18 mm	D/Blister	10 / 30
65880	21 mm	D/Blister	10 / 60

16 mm
18 mm
21 mm

POWER GRIP, CHIAVE SVITACANDELE CON BUSSOLA SNODATA
Bussola con anello fermacandela in gomma
POWER GRIP, T-HANDLE SPARK PLUG SOCKET WRENCH SWIVEL SOCKET
Inner rubber retention ring.

65871	16 mm
65872	21 mm

16 mm
21 mm

Cartoncino / Card 10 / 50

CHIAVE SVITACANDELE SNODABILE CON DOPPIA BUSSOLA INTERCAMBIABILE
TWIN SOCKET SPARK PLUG T-HANDLE WRENCH

65881	16+21 mm
--------------	----------

16+21 mm

D/Blister 10 / 50

CHIAVE SVITACANDELE SNODABILE
Lunghezza manico cm 15.
Con tripla bussola intercambiabile
SPARK PLUG T-HANDLE WRENCH
Handle length cm 15.
Interchangeable sockets

65882	16+18+21 mm
--------------	-------------

16+18+21 mm

D/Blister 10 / 30

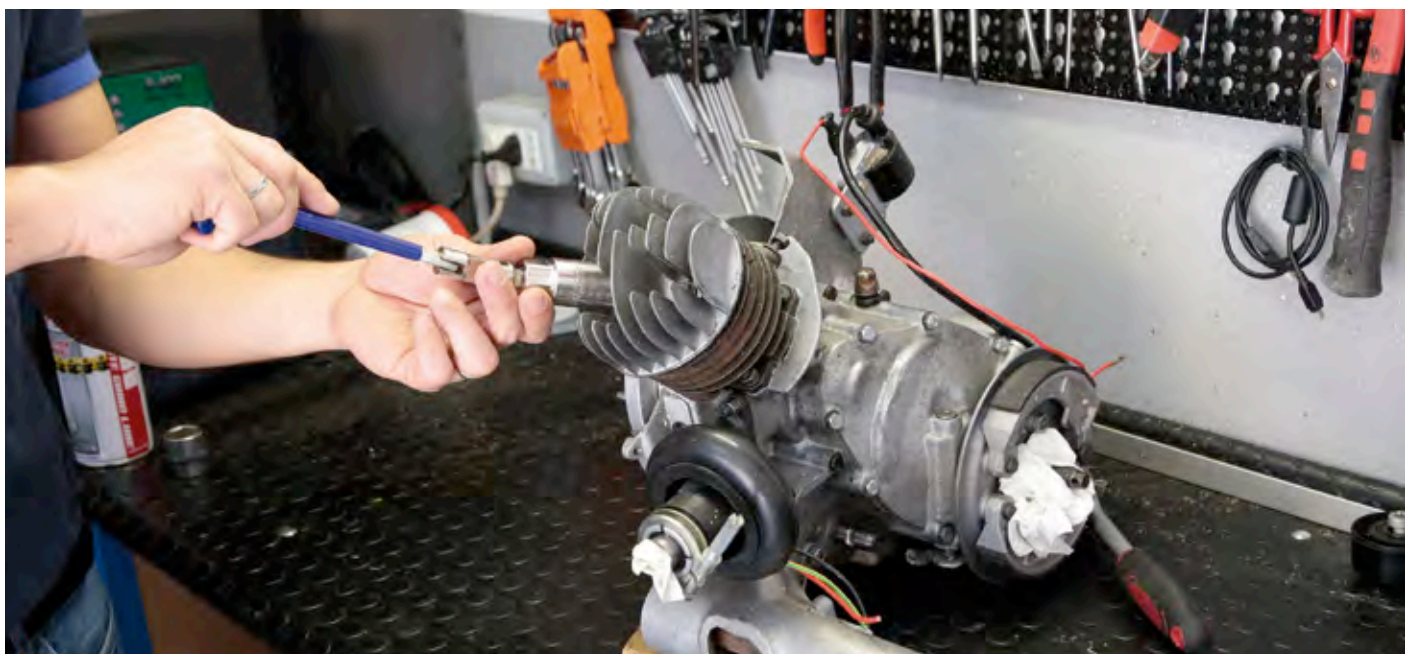



Ø 10 mm

**CHIAVE SVITACANDELE
SNODABILE MANICO LUNGO**
Lunghezza manico cm 50.

**LONG T-HANDLE SPARK
PLUG WRENCH**
Handle length cm 50.

65970	16 mm	Cavaliere / Header	15 / 30
65940	21 mm	Cavaliere / Header	10 / 30

16 mm
21 mm



Ø 12 mm
PROFESSIONAL

**CHIAVE SVITACANDELE
PROFESSIONAL**
Snodabile, manico lungo 50 cm
**PROFESSIONAL SERIES LONG
T-HANDLE SPARK PLUG**
50 cm long T-handle

65942	21 mm
65943	16 mm

Cavaliere / Header 10 / 20

16 mm
21 mm



Magnet



Rivestimento
Nickel
Coating

Forza Magnetica

35N 42N

Magnetic Force

DISCO MAGNETICO AL NEODIMIO
Rivestimento nickel

NEODYMIUM MAGNETIC DISK
Nickel coating

98047	25x10 mm	35 N	Ord. min. (MOQ) 36 pz	Sfuso / Bulk	36 / 288
97720	27x10 mm	35 N	Ord. min. (MOQ) 6 pz	Blister	6 / 48
97721	30x7 mm	42 N	Ord. min. (MOQ) 36 pz	Sfuso / Bulk	36 / 288
97722	30x7 mm	42 N	Ord. min. (MOQ) 8 pz	Blister	8 / 64





CHIAVE SVITAFILTRO OLIO A CATENA
CHAIN OIL FILTER WRENCH

74151

D/Blister 10 / 60



8-10 mm

12 mm

QUADRA
Chiave svitapetto olio, 8/10 mm
QUADRA, OIL DRAIN WRENCH
Square type, 8/10 mm

65902

D/Blister 20 / 60

CHIAVE SVITATAPPO OLIO
Esagonale maschio 12 mm.
HEXAGON HEX KEY
WRENCH 12 MM

65904

D/Blister 20 / 100

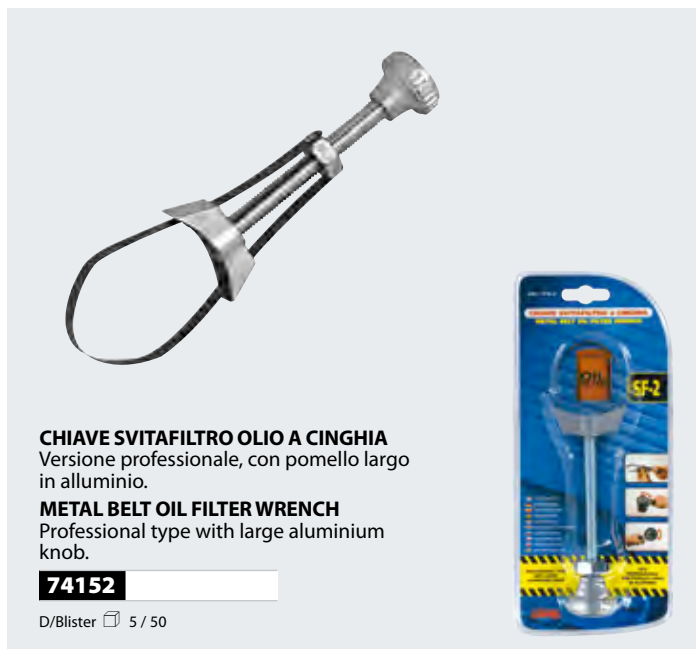

CHIAVE SVITAFILTRO OLIO A CINGHIA
Versione professionale, con pomello largo in alluminio.

METAL BELT OIL FILTER WRENCH
Professional type with large aluminium knob.

74152

D/Blister 5 / 50



6 L

GARAGE, VASCHETTA CAMBIO OLIO
Capacità 6 litri. Per cambio olio, lavaggio parti auto-moto.

GARAGE, PLASTIC OIL DRAIN PAN
Capacity 6 litres.

65905

Sfuso / Bulk 5 / 25



CHIAVE SVITAFILTRO OLIO A CATENA TIPO PROFESSIONALE
Con manico in lega. Universale per tutti i filtri.
CHAIN TYPE OIL FILTER WRENCH
PROFESSIONAL TYPE

74153

D/Blister 12 / 48



6 L

ECO TANICA - 6 LITRI
Per la raccolta ed il trasporto dell'olio esausto.

ECO TANICA - 6 LITRES
Plastic oil drain pan and canister.

65906

Sfuso / Bulk 6



⊕ ISO 8764

⊖ ISO 2380

GIRAVITI

In acciaio cromo vanadio. Impugnatura bicomponente, con grip morbido e antiscivolo. Confezione singola.

SCREWDRIVERS

Chrome vanadium steel. Soft bi-component grip

59528	⊕	PH0 x 60 mm
59529	⊕	PH1 x 75 mm
59530	⊕	PH2 x 100 mm

Cavaliere / Header □ 12 / 240

59520	⊖	0,5 x 3 x 75 mm
59521	⊖	0,8 x 4 x 100 mm
59522	⊖	1 x 5,5 x 125 mm
59523	⊖	1,2 x 6,5 x 125 mm

Cavaliere / Header □ 12 / 240

CONFEZIONE SINGOLA
SINGLE-PACK

1
pc



6 pcs
SET

⊖ ISO 2380

⊕ ISO 8764

**IL SET INCLUDE:
THE SET INCLUDES:**

1X	⊖	0,8 x 4 x 75 mm
1X	⊖	1,20 x 6 x 100 mm
1X	⊖	1,25 x 8 x 150 mm
1X	⊕	PH1 x 75 mm
1X	⊕	PH2 x 100 mm
1X	⊕	PH3 x 150 mm

SET 6 GIRAVITI ASSORTITI

In acciaio cromo vanadio. Impugnatura bicomponente, con grip morbido e antiscivolo. Norma: (-) ISO 2380 (+) ISO 8764

ASSORTED SCREWDRIVER SET, 6 PCS

Chrome vanadium steel. Soft bi-component grip

59532

D/Blister □ 10 / 20





**CHIAVE COMBINATA
CON CRICCHETTO SNODATO**

In acciaio cromo vanadio.
Confezione singola, con cavaliere in plastica

FLEXIBLE GEAR WRENCH

Chrome vanadium steel.
Single pack with plastic hanger

59555	8 mm	Cavaliere / Header	15 / 150
59556	10 mm	Cavaliere / Header	15 / 150
59557	11 mm	Cavaliere / Header	13 / 130
59558	13 mm	Cavaliere / Header	8 / 80
59559	15 mm	Cavaliere / Header	7 / 70
59560	17 mm	Cavaliere / Header	8 / 80
59561	19 mm	Cavaliere / Header	7 / 70
59562	20 mm	Cavaliere / Header	6 / 60
59563	21 mm	Cavaliere / Header	5 / 50
59564	22 mm	Cavaliere / Header	5 / 50
59565	23 mm	Cavaliere / Header	5 / 50

CRV
FINITURA SATINATA
SATIN FINISHING

CONFEZIONE SINGOLA
SINGLE-PACK

1
pc



CRICCHETTO SNODABILE
ARTICULATED RATCHET



CHIAVI COMBINATE

In acciaio cromo vanadio.
Confezione singola, con cavaliere in plastica

COMBINATION WRENCHES

Chrome vanadium steel.
Single pack with plastic hanger

59503	6 mm	Cavaliere / Header	25 / 800
59504	8 mm	Cavaliere / Header	25 / 500
59505	10 mm	Cavaliere / Header	25 / 350
59506	11 mm	Cavaliere / Header	25 / 300
59507	13 mm	Cavaliere / Header	25 / 200
59508	15 mm	Cavaliere / Header	25 / 150
59509	17 mm	Cavaliere / Header	25 / 150
59510	19 mm	Cavaliere / Header	25 / 100
59511	21 mm	Cavaliere / Header	25 / 50
59512	23 mm	Cavaliere / Header	10 / 60

1
pc

DIN 3113 A

CONFEZIONE SINGOLA
SINGLE-PACK



8 pcs SET



SET 8 CHIAVI A FORCHETTA
6/7-8/9-10/11-12/13-14/15-16/17-18/19-20/22 mm

SET 8 DOUBLE OPEN END WRENCHES
6/7-8/9-10/11-12/13-14/15-16/17-18/19-20/22 mm

59500

Film + Cavaliere / Header 1 / 30

6 ↔ 22 mm

DIN 895



12 pcs SET

**CRV
FINITURA AL NICKEL
NICKEL FINISHING**

SET 12 CHIAVI COMBinate
Misure: 6-7-8-9-10-11-12-13-14-17-19-22.
In acciaio cromo vanadio

SET 12 COMBINATION OPEN&RINGED SPANNER
Sizes: 6-7-8-9-10-11-12-13-14-17-19-22.
Chrome vanadium steel

59501

Film + Cavaliere / Header 1 / 20



6 ↔ 22 mm

DIN 3113 A



MARTELLO 0,5 KG
Con manico in legno
HAMMER 0,5 KG
With wood handle

59545

Etichetta 6 / 36



MAZZETTA 1 KG
Con manico in legno
HAMMER 1 KG
With wood handle

59546

Etichetta 6 / 18



SET CRICCHETTO CON INSERTI E BUSSOLE, 19 PZ

- 1 cricchetto
- 6 bussole: 5, 6, 7, 8, 9, 10 mm
- 3 inserti croce: PH0, PH1, PH2
- 5 inserti taglio: SL3, SL4, SL5, SL6, SL7
- 4 inserti torx: T10, T15, T20, T30

RATCHET WITH BITS AND SOCKETS, 19 PCS SET

- 1 ratchet handle
- 6 drive sockets: 5, 6, 7, 8, 9, 10 mm
- 3 bits phillips: PH0, PH1, PH2
- 5 bits slotted: SL3, SL4, SL5, SL6, SL7
- 4 bits torx: T10, T15, T20, T30

59551Scatola Plast. / Box  6 / 24**19 pcs****SET CACCIAVITE CON INSERTI, 21 PZ**

- 1 cacciavite a cricchetto
- 4 inserti croce: PH0, PH1, PH2, PH3
- 6 inserti taglio: SL3, SL4, SL5, SL6, SL6.5, SL7
- 5 inserti esagonali: H2, H3, H4, H5, H6
- 5 inserti torx: T10, T15, T20, T25, T30

SCREWDRIVER WITH BITS, 21 PCS SET

- 1 ratchet screwdriver
- 4 bits phillips: PH0, PH1, PH2, PH3
- 6 bits slotted: SL3, SL4, SL5, SL6, SL6.5, SL7
- 5 bits hex: H2, H3, H4, H5, H6
- 5 bits torx: T10, T15, T20, T25, T30

59552Scatola Plast. / Box  6 / 24**21 pcs****SET CACCIAVITE CON INSERTI E BUSSOLE, 30 PZ**

- 1 cacciavite a cricchetto
- 1 adattatore per inserti di precisione
- 1 adattatore per bussole
- 6 bussole: 5, 6, 7, 8, 9, 10 mm
- 3 inserti croce: #0, #1, #2
- 3 inserti taglio: SL4, SL5, SL6
- 2 inserti croce pozidrive: #0, #1
- 3 inserti esagonali: 4, 5, 6 mm
- 2 inserti torx: SD10, SD15
- 3 inserti di precisione croce #00, #0, #1
- 3 inserti di precisione taglio SL2, SL3, SL4
- 2 inserti di precisione torx SD10, SD20

SCREWDRIVER WITH BITS AND SOCKETS, 30 PCS SET

- 1 ratchet screwdriver
- 1 precision bit adapter
- 1 socket adapter
- 6 drive sockets: 5, 6, 7, 8, 9, 10 mm
- 3 bits phillips: #0, #1, #2
- 3 bits slotted: SL4, SL5, SL6
- 2 bits cross point star: #0, #1
- 3 bits hex: 4, 5, 6 mm
- 2 bits torx: SD10, SD15
- 3 precision bits phillips #00, #0, #1
- 3 precision bits slotted SL2, SL3, SL4
- 2 precision bits torx SD10, SD20

59553Scatola Plast. / Box  6 / 24**30 pcs**



5 in 1

SUPER-DRIVE

Giravite universale con 5 inserti intercambiabili in acciaio. 4 portainseri ricavati nell'impugnatura

SUPER-DRIVE

Screwdriver set with 5 interchangeable bits, soft grip.

65988

D/Blister 10 / 50



20 bits

CACCIAVITE A "T"

Con 9 chiavi a bussola e 11 inserti intercambiabili.

T-HANDLE COMBINATION SET

With 9 sockets and 11 bits.

65992

D/Blister 10 / 50



0,9 - 1,2 - 1,8 - 2,4 - 3 - 3,5 mm

**SET 6 MICROCACCIAVITI AD INTAGLIO
6 PCS PRECISION SCREWDRIVER SET**

65993

D/Blister 20 / 100



1,5 - 2 - 2,5 - 3 - 4 - 5 - 6 - 8 mm

**SET 8 PZ CHIAVI ESAGONALI MASCHIO
8 PCS HEX KEY SET ON A RING**

65995

D/Blister 20 / 100



T8 - 10 - 15 - 20 - 23 - 27 - 30 - 40

**SET 8 PEZZI CHIAVI ESAGONALI TIPO TORX
8 PCS HEX KEY SET "TORX" STYLE**

66051

D/Blister 12 / 72



**PINZA REGOLABILE
A CERNIERA CHIUSA**

Verniciata rossa

**SLIP JOINT PLIERS
BOXED JOINT**

Red varnished

59538 250 mm

Cavaliere / Header 10 / 40



6 LED

3 AAA

SET 7 GIRAVITI CON TORCIA A LED

Dimensioni compatte per alloggiamento nel vano portaoggetti

SCREWDRIVER SET WITH LED TORCH

Compact size for storage in glove compartment

65974

1 pz

Sfuso / Bulk 12 / 48

65974D

Display 12 pz

Scatola / Box 1

Display 12 pcs



8 in 1



PINZA PER CAPICORDA

Per tagliare, spelare fili e per serrare capicorda

CRIMPING PLIERT

For cutting and crimping automotive cables.

70027

D/Blister 10 / 100



EXAGONAL



CRV

FINITURA AL NICKEL
NICKEL FINISHING

9 pcs SET

10 mm	46x117 mm
8 mm	39x104 mm
6 mm	33x92 mm
5 mm	29x87 mm
4 mm	26x76 mm
3 mm	20x65 mm
2,5 mm	18x57 mm
2 mm	16x51 mm
1,5 mm	15x46 mm

SET CHIAVI MASCHIO ESAGONALI
In acciaio cromo vanadio
EXAGONAL KEY SET
Chrome vanadium steel material

66003

D/Blister 12 / 96



TORX



CRV

FINITURA AL NICKEL
NICKEL FINISHING

9 pcs SET

T 50	47x130 mm
T 45	42x119 mm
T 40	37x107 mm
T 30	33x93 mm
T 27	28x87 mm
T 25	24x75 mm
T 20	22x67 mm
T 15	20x60 mm
T 10	17x64 mm

SET CHIAVI MASCHIO TORX®
In acciaio cromo vanadio
TORX® KEY SET
Chrome vanadium steel material

66004

D/Blister 12 / 96

Min 0,5 mm²
Max 4 mm²

PINZA SPELAFILI AUTOMATICA
Per fili da Ø 0,5 a 4 mm².
Lunghezza di spelatura regolabile.
Tagliafilari incorporato

AUTOMATIC WIRE STRIPPER
Suitable for wires from 0,5 to 4 mm².
Wire cutter peeling length
Adjustable peeling length

66005 170 mm

D/Blister 10 / 50

FORBICI OFFICINA
Lama micro-dentellata antiscivolo.
Impugnatura ergonomica a doppia densità.
Spelafili integrato

MECHANICAL SCISSORS
Anti-slip indented blade.
Ergonomic handle with double density.
Wire stripper integrated

66006 140 mm

D/Blister 10 / 200

SALDATORE A STAGNO, 12V - 30W
Punta intercambiabile.
Stagno incluso (130 cm)

SOLDERING IRON, 12V - 30W
Interchangeable tip.
130 cm coil tin included

66007 12V - 30 W

D/Blister 100

CRV
CROMO VANADIO

8"
200mm

CHIAVE REGOLABILE A RULLINO, 8"
In acciaio cromo vanadio.
ADJUSTABLE WRENCH, 8"
Chrome vanadium steel.

59502

Cavaliere / Header 10 / 60

7"



PINZA COMBINATA
Lunghezza 180 mm, 7".
In acciaio cromo vanadio.
Impugnatura bicomponente,
con grip morbido antiscivolo.

COMBINATION PLIERS
Lenght 180 mm, 7".
Chrome vanadium steel.
Soft bi-component grip.

59535

Cavaliere / Header 6 / 60



CRV
FINITURA AL NICKEL
NICKEL FINISHING

6"



PINZA BECCHI LUNGH
Lunghezza 160 mm, 6".
In acciaio cromo vanadio.
Impugnatura bicomponente,
con grip morbido antiscivolo.

LONG NOSE PLIERS
Lenght 160 mm, 6".
Chrome vanadium steel.
Soft bi-component grip.

59536

Cavaliere / Header 6 / 60



CRV
FINITURA AL NICKEL
NICKEL FINISHING

6"



PINZA BECCHI CURVI
Lunghezza 160 mm, 6".
In acciaio cromo vanadio.
Impugnatura bicomponente,
con grip morbido antiscivolo.

BENT NOSE PLIERS
Lenght 160 mm, 6".
Chrome vanadium steel.
Soft bi-component grip.

59537

Cavaliere / Header 6 / 60



CRV
FINITURA AL NICKEL
NICKEL FINISHING

6"



TRONCHESINO
Lunghezza 160 mm, 6".
In acciaio cromo vanadio.
Impugnatura bicomponente,
con grip morbido antiscivolo.

DIAGONAL CUTTING PLIERS
Lenght 160 mm, 6".
Chrome vanadium steel.
Soft bi-component grip.

59540

Cavaliere / Header 6 / 60



CRV
FINITURA AL NICKEL
NICKEL FINISHING



15 in 1



15 IN 1 PINZA TASCABILE
SURVIVAL MULTIFUNZIONE DA 6"
In acciaio inox con custodia in
cordura.

15 IN 1 SURVIVAL 6"
MULTIFUNCTION POCKET TOOL
Stainless steel, with pouch.

66141

D/Blister 12 / 48



11 in 1



11 IN 1 COLTELLO TASCABILE
SURVIVAL MULTIFUNZIONE
In acciaio inox con custodia in
cordura.

11 IN 1 SURVIVAL
MULTIFUNCTION POCKET KNIFE
Stainless steel, with pouch.

66142

D/Blister 12 / 48

NASTRO ANTISCIVOLO

- Resistente all'acqua, all'olio, ai detersivi, ai solventi, ai raggi UV e alle temperature estreme.
- Adesivo di lunga durata

ANTI-SLIP ADHESIVE TAPE

- Reduces the risk of accidents on slippery, uneven or split level floor surfaces.
- Durable

98891 Nero Black

D/Blister 9 / 54

5x500 cm



NASTRO PER RIPARAZIONE FANALI

- Specifico per riparare crepe, fori o fessure presenti sulle lenti dei fanali.
- Altissima trasparenza, spessore maggiorato, adesivo speciale.
- Evita l'infiltrazione di acqua e sporizia nel fanale

AUTO LENS REPAIR TAPE

- Repairs cracked or broken lenses of any vehicle.
- Special thickness and adhesive.
- Standout in the crowd

Blister 20 / 200

41530	Neutro	Clear
41531	Ambra	Amber
41532	Rosso	Red

5x150 cm

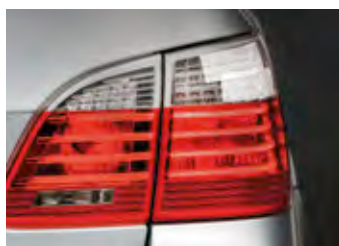

Ø 11,8 cm

Forza massima
30 Kg
Max Strength

VENTOSA A TRAZIONE PER CARROZZERIA

Tirabolle per ripristino ammaccature su carrozzeria ed altri usi domestici, industriali e fai da te

DENT PULLER SUCTION CUP

Multiusage

59516 Ø 11,8 cm

Scatola / Box 12 / 48



PRIMA

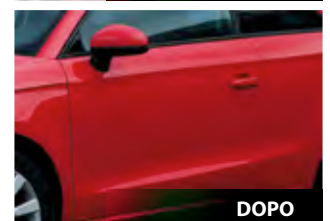

DOPO



25 m

NASTRO ADESIVO TIPO AMERICANO - 50 mm x 25 m
 Multiuso, universale, incolla, sigilla, protegge, ripara... Prodotto in polietilene rinforzato ad alta resistenza meccanica, impermeabile e conformabile. Si strappa con le mani senza l'ausilio di attrezzi da taglio. Alta adesività, idoneo a tutte le superfici lisce e ruvide.

DUCT TAPE - 50 mm x 25 m
 General purpose adhesive tape. For sealing, repairing, protecting, fixing. Reinforced polythene sheets with superior mechanical force. Waterproof, soft and conformable. May be torn off by hand at perfect size, without any cutting tool. High adhesiveness on practically any smooth or rough surfaces.

98878	Grigio	Grey
98879	Nero	Black

D/Blister 9 / 54



15 m

NASTRO ADESIVO TIPO AMERICANO - 50 mm x 15 m
 Multiuso, universale, incolla, sigilla, protegge, ripara... Prodotto in polietilene rinforzato ad alta resistenza meccanica, impermeabile e conformabile. Si strappa con le mani senza l'ausilio di attrezzi da taglio. Alta adesività, idoneo a tutte le superfici lisce e ruvide.

DUCT TAPE - 50 mm x 15 m
 General purpose adhesive tape. For sealing, repairing, protecting, fixing. Reinforced polythene sheets with superior mechanical force. Waterproof, soft and conformable. May be torn off by hand at perfect size, without any cutting tool. High adhesiveness on practically any smooth or rough surfaces.

98880	Grigio	Grey
98881	Nero	Black

D/Blister 9 / 54



10 m

NASTRO ADESIVO RINFORZATO - 48 mm x 10 m
 Ripara, isola, protegge, rinforza. Indispensabile in auto, casa, giardino, camping, etc...
 Si strappa con le mani senza l'utilizzo della forbice

REINFORCED REPAIR TAPE - 48 mm x 10 m
 Repairs, isolates, protects, reinforces. Indispensable in the car, at home, in the garden, on campings, outdoors...

98877

D/Blister 9 / 54



3 m

NASTRO AUTOAGGLOMERANTE IN EPR - 25 mm x 3 m
 Impermeabile, isolante, molto elastico, resistente alle alte temperature e ai raggi UV. Ideale per unire o riparare tubi, condutture, manicotti, etc. Compatibile con una vasta gamma di gomme e plastiche. Spessore 0,80 mm

EPR SELF-AMALGAMATING TAPE - 25 mm x 3 m
 A very useful derivative of insulating tape which can be used for waterproofing connections. To use, the top protective layer is peeled off and the rubber self-amalgamating tape underneath is wrapped tightly around the connection to be waterproofed. Eventually, the layers of this tape will merge together and create a waterproof seal.

98882

D/Blister 10 / 80



5 m

NASTRO BIADESIVO
 Multiuso, adesivo ad alta resistenza

DOUBLE SIDED ADHESIVE TAPE

70011	12 mm x 5 m
70012	16 mm x 5 m

D/Blister 10 / 160



5 m

NASTRO BIADESIVO SPECIALE
 Multiuso, adesivo ad alta resistenza

SPECIAL DOUBLE SIDED ADHESIVE TAPE

70015	5 mm x 5 m
70016	10 mm x 5 m
70017	15 mm x 5 m

D/Blister 10 / 100



5 m

SET 10 NASTRI BIADESIVO SPECIALE
SET 10 PCS SPECIAL DOUBLE-ADHESIVE TAPE

70008	6mm x 5m
70009	12mm x 5m
70010	18mm x 5m

Busta / Bag 5 / 20

SET 6 NASTRI ADESIVI ISOLANTI IN PVC STANDARD
Colori assortiti. Rotoli da 3,4 m x 19 mm
6 PCS SET PVC STANDARD INSULATING TAPES
Assorted colours, rolls of 3,4 m x 19 mm
70026
D/Blister 10 / 60

Spessore 0,18 mm Thick
Omologati Approved
RoHS
SET 6 NASTRI ISOLANTI ADESIVI OMOLOGATI IN PVC PLASTIFICATO
Colori assortiti. Rotoli da 4,5 m x 19 mm
6 PCS SET APPROVED PVC INSULATING ADHESIVE TAPES
Assorted colours rolls of 4,5 m x 19 mm
70028
Blister 10 / 40

NASTRO A STRAPPO 2X90 CM
Base adesiva. Gli oggetti possono essere staccati e riposti ripetutamente senza perdere l'effetto di presa.
Multiuso, per auto, camper, casa, ufficio...
HOOK & LOOP TAPE 2X90 CM
Adhesive base, sticks to most surfaces.
Universal use for car, motorhome, office...
70013
Blister 10 / 80

SET 12 NASTRI A STRAPPO
Pre-Formati con adesivo sui 2 lati (maschio+femmina). Gli oggetti possono essere staccati e riposti ripetutamente senza perdere l'effetto di presa
HOOK & LOOP TAPES SET, 12 PCS
Adhesive base, sticks to most surfaces.
Universal use for car, motorhome, office...
70014
Blister 10 / 100

x6 x4
Ø 2,5 cm 2,5x2,5 cm
x2
7,5x2,5 cm

COLLA SUPER-RAPID
Adesivo istantaneo universale. Contenuto netto 3 gr.
EXTRA-STRONG CYANOACRYLATE ADHESIVE GLUE. Net content: 3 gr.
38181
Blister 36 / 288

KIT 2 CUTTERS MULTIUSO
2 PCS MULTIPURPOSE CUTTERS
65998
D/Blister 12 / 72

CUTTER PROFESSIONALE
Con autoricarica 6 lame. Rotaia scorilama in acciaio con funzione di inversione taglio. Impugnatura in morbida gomma antiscivolo
PERFORMER PROFESSIONAL CUTTER
6 blades auto re-load tray
66002
D/Blister 10 / 100



SET 75 PZ FASCETTE IN NYLON PER CAVI
Nelle misure 90 - 120 - 190 mm
SET 75 PCS ASSORTED NYLON CABLE TIES
Sizes 90 - 120 - 190 mm

70024

D/Blister 24 / 144



FASCETTE FERMACAVO
Serie Color-Tuning per la decorazione del vano motore.
100 pz colori assortiti
TUNING-DECOR CABLE TIES
For engine compartment decoration.
100 pcs assorted colours

70018	0,25x15 cm
70019	0,46x20 cm

D/Blister 10 / 120



FASCETTE FERMACAVO, 100 PZ
0,46x30 cm
CABLE TIES, 100 PCS
0,46x30 cm

70038	Nero	Black
70039	Grigio	Grey

Busta / Bag 10 / 80

0,46 x 30cm



FASCETTE FERMACAVO, 100 PZ
0,46x45 cm
CABLE TIES, 100 PCS
0,46x45 cm

70001	Nero	Black
70002	Grigio	Grey

Busta / Bag 10 / 60

0,46 x 45cm

CABLE-FIX, CLIPS FERMACAVI ADESIVE
Per fermare i cavetti di auricolari, caricatori cellulari, alimentatori usb, navigatori satellitari, cuffie...

CABLE-FIX, ADHESIVE CABLE CLIPS
To hold, organise, and keep firm in position small cables of phone chargers, usb cables, gps navigator, earphones.



70036	6 pz	D/Blister 10 / 100
70037	50 pz	Busta / Bag 5 / 50

2 CAVI
2 CABLES

CABLE-CLAMP, CLIPS FERMACAVI ADESIVE
Per fermare i cavetti di auricolari, caricatori cellulari, alimentatori usb, navigatori satellitari, cuffie...

CABLE-CLAMP, ADHESIVE CABLE CLIPS
To hold, organise, and keep firm in position small cables of phone chargers, usb cables, gps navigator, earphones.



70034	6 pz	D/Blister 10 / 100
--------------	------	---------------------

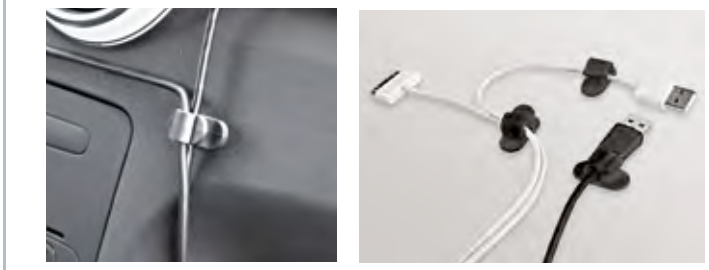

**KIT NASTRO ACCIAIO
CON 8 MORSETTI**
Universale per tubi, filtri, raccordi...
**COIL-SET HOSE-BAND
WITH 8 CLIPS**
70023 300 cm
D/Blister 10 / 200

FILO ACCIAIO ZINCATO
Ø 0,5 mm x 10 m
Multiuso
GALVANIZED STEEL WIRE
Ø 0,5 mm x 10 m
59541
D/Blister 10 / 50

26 pcs
KIT FASCETTE STRINGITUBO IN ACCIAIO, 26 PZ
Serraggio vite tramite cacciavite ad intaglio o chiave
COIL-SET HOSE BAND MADE OF STEEL, 26 PCS
Tightening with screwdriver for slotted head screws or wrench
70033
Scatola / Box 10 / 40

Ø 16 mm 8 Pz Pcs Stk	Ø 22 mm 6 Pz Pcs Stk	Ø 25 mm 4 Pz Pcs Stk
Ø 28 mm 2 Pz Pcs Stk	Ø 35 mm 2 Pz Pcs Stk	Ø 40 mm 4 Pz Pcs Stk



4,7 x 300 mm
4,7 x 200 mm
7,9 x 300 mm

SET 20 FASCETTE IN ACCIAIO INOX
Ideali per applicazioni moto, auto, camion.
Robuste, multiuso, professionali.
Resistenti alle alte temperature
STAINLESS STEEL CABLE TIES, 20 PCS SET
Strong, multi-use, professional.
For bike, car, truck.
Resistant to high temperatures
69987 4,7x200 mm
69988 4,7x300 mm
69989 7,9x300 mm
20 pcs SET
Acciaio inox
Stainless steel



max
345 mm

↑
↓

min
130 mm

Max
2000
Kg

CRIC IDRAULICO A CARRELLO
GS-TÜV. Lunghezza 47 cm,
con maniglia per trasporto

HYDRAULIC TROLLEY JACK
GS-TÜV approved. Length 47 cm.
With carry handle

71510	2.000 kg	Scatola / Box	1
71511	2.000 kg	Valigetta / Case	1

**CRIC IDRAULICO A CARRELLO,
BASSO PROFILO - 2.500 KG**
Particolarmente adatto per auto ribassate.
Omologato GS-TÜV.
Alzata 85-455 mm, lunghezza 60 cm

**LOW-PROFILE HYDRAULIC
GARAGE FLOOR JACK - 2.500 KG**
Suitable for cars with low profile
GS-TÜV approved
Lifting range 85-455 mm, length 60 cm

71512

Scatola / Box 1

85mm

**PROFILO RIBASSATO
LOW PROFILE**



Max
2500
Kg

max
455 mm

↑
↓

min
85 mm

Max
1000
Kg

TAMPONE IN GOMMA
RUBBER PAD

CRIC A PANTOGRAFO CON CRICCHETTO - 1.000 KG
Alzata 100-350 mm. Omologato a norma di sicurezza europea 2006/42/EC. Veloce e facile da utilizzare

SCISSOR JACK WITH RATCHET - CAPACITY 1.000 KG
Lifting range 100-350 mm.
According to European safety standards

71502 1.000 kg

Scatola / Box 8

Omologazione Europea
CE 2006 / 42 / EC
European Safety Standards

max
350 mm
↑
min
100 mm

Con Cricchetto
With Ratchet



Max
1000
Kg

TAMPONE IN GOMMA
RUBBER PAD

CRIC A PANTOGRAFO
Omologato GS-TÜV. Alzata 100-350 mm

SCISSOR JACK
GS-TÜV approved. Lifting range 100-350 mm

71500 1.000 kg

Scatola / Box 8

Omologazione Europea
CE 2006 / 42 / EC
European Safety Standards

max
350 mm
↑
min
100 mm

Con manovella
With crank



Max
2000
Kg

TAMPONE IN GOMMA
RUBBER PAD

CRIC A PANTOGRAFO - 2.000 KG
Omologato GS-TÜV. Alzata 98-442 mm

SCISSOR JACK - 2.000 KG
GS-TÜV approved. Lifting range 98-442 mm

71501 2.000 kg

Scatola / Box 6

Omologazione Europea
CE 2006 / 42 / EC
European Safety Standards

SUV, 4x4

max
442 mm
↑
min
98 mm

Con manovella
With crank





CRIC IDRAULICO
Omologato GS-TÜV
HYDRAULIC BOTTLE JACK
GS-TÜV approved



	Alzata / Lifting		
71550	2.000 kg	165-315 mm	8
71552	3.000 kg	193-373 mm	6
71551	5.000 kg	196-410 mm	6
71554	10.000 kg	190-380 mm	4
71555	20.000 kg	190-380 mm	2

Scatola / Box



PIEGHEVOLE FOLDABLE

1 pc

CAVALLETTO TREPPEDI PIEGHEVOLE
Omologato GS-TÜV, 5 livelli di estensione.
FOLDABLE JACK-STAND
GS-TÜV approved. Adjustable at 5 levels.

71514 2.000 kg

Scatola / Box 8

Max 2000 Kg

max 363 mm
↑
min 276 mm



2 pcs

COPPIA CAVALLETTI OFFICINA
Professionali, omologati GS-TÜV. 3 livelli di estensione
2 PCS JACK STANDS
Professional use, adjustable at 3 levels

71516 1.800 kg

Scatola / Box 3

Max 1800 Kg

max 370 mm
↑
min 280 mm



**CARRELLO SOTTOMACCHINA**

Tipo professionale, stampata unica,
ruote sterzanti con cuscinetti

PROFESSIONAL GARAGE CREEPER

One piece construction.
Wheels with ball bearings.

71520 100x49 cm

Scatola / Box  1

**CARRELLO SOTTOMACCHINA ANATOMICO CON POGGIATESTA**

Prodotto interamente in plastica rinforzata, forte e durevole.
6 rotelle con cuscinetti a sfere

GARAGE CREEPER WITH HEAD REST

Made entirely of 1 piece reinforced plastic, strong and durable. Padded head-rest, 6 wheels with ball bearings

71521 90x40 cm

Scatola / Box  1



SOLLEVATORE IDRAULICO PER POSIZIONAMENTO VEICOLI
Facile e rapido da utilizzare, senza toccare il telaio del veicolo. Idoneo per spostare facilmente il veicolo in tutte le direzioni. Sollevamento stabile e progressivo grazie al sistema idraulico a pedale. Telaio in acciaio rigido con portata fino a 680 kg per ogni sollevatore. Universale per pneumatici fino a 300 mm di larghezza e veicoli fino a 1600 kg di peso. Quattro ruote per una facile manovrabilità

HYDRAULIC VEHICLE POSITIONING JACK
Easy lifts vehicle without touching frame. Rolls easily in any direction. Smoothly raises vehicle in just seconds. Rigid steel frame, 680 kg capacity for jack. Hydraulic ram provides a stable action. Easy foot-pedal lifting. Handle tires up to 300 mm wide and vehicle up to 1600 kg weight. Four wheels for easy maneuverability

71505

Scatola / Box 1

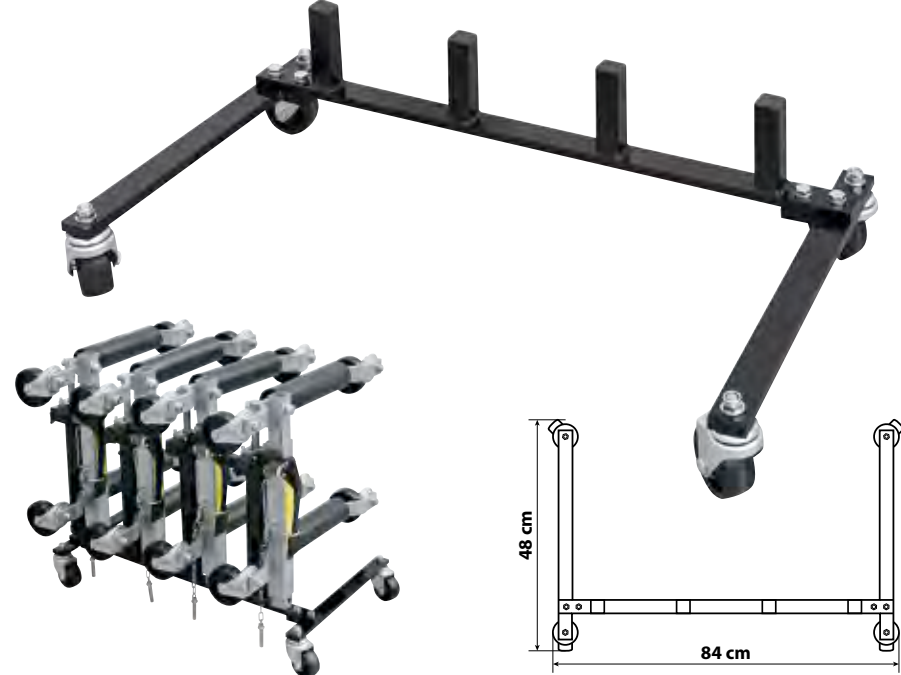
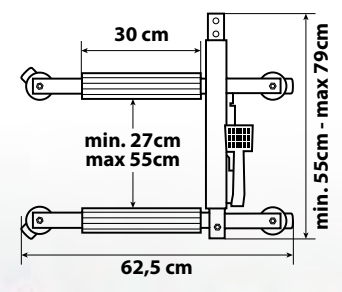

RASTRELLIERA PER 4 SOLLEVATORI IDRAULICI
Ideale per riporli comodamente in poco spazio. Con ruote

RACK FOR FOUR HYDRAULIC VEHICLE POSITIONING JACKS
With wheels

71506

Scatola / Box 1





CHIAVE A CROCE
17-19-21-22 mm. Lunghezza mm 380

CROSS RIM WRENCH
17-19-21-22 mm. Length mm 380

65920

Sfuso / Bulk 12

DIN 3119

17-19-21-22 mm

TUV GS (Germanische Sicherheit)



CHIAVE A CROCE RIPIEGABILE
17-19-21-23 mm. Resistente e compatta per un più facile alloggiamento nel baule. Lunghezza mm 380

FOLDING LUG WRENCH CHROME-PLATED
17-19-21-23 mm. Heavy duty construction. Easy storage. Length 380 mm

65921

Busta + Cartoncino / Bag+Card 12

Ripiegabile
Foldable

17-19-21-23 mm

TUV GS (Germanische Sicherheit)



SB-1, SVITABULLONI TELESCOPICO
Con chiave reversibile 17-19 mm. Omologazione europea

SB-1, TELESCOPIC WHEEL NUT WRENCH
Reversible socket 17-19 mm. European approval

65923

D/Blister 6 / 12

17-19 mm

TUV GS (Germanische Sicherheit)



SB-2, SVITABULLONI TELESCOPICO
Con doppia chiave reversibile 17-19 e 21-23 mm. Omologazione europea

SB-2, TELESCOPIC WHEEL NUT WRENCH
Double reversible socket 17-19 and 21-23 mm. European approval

65924

D/Blister 6 / 12

17-19 + 21-23 mm

TUV GS (Germanische Sicherheit)



GENIO, CHIAVE SVITABULLONI ROTANTE
Cromata, con custodia in nylon e 2 adattatori per bulloni e viti da 17/19 e 21/23 mm. Semplice e compatta

GENIO, SPINNING LUG WRENCH
2 sockets for 17/19 and 21/23 mm. Easy to use, compact size



65932

D/Blister 5 / 10

PERNO ROTANTE
SPINNING

CUSTODIA IN NYLON
NYLON POUCH

17-19-21-23 mm

19 mm / 23 mm and **17 mm / 21 mm**

 17-19-21 mm

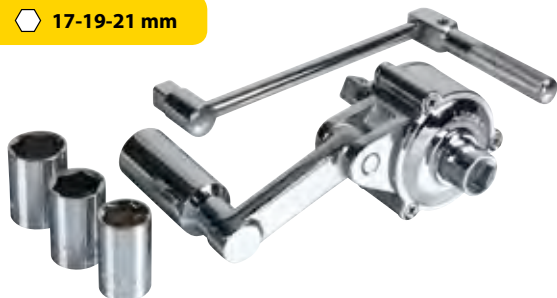
MOLTIPLICATORE DI FORZA PER VITI RUOTE, AUTO E FURGONI

Ideale per allentare o stringere dadi/ bulloni delle ruote

Rapporto 1:56 (1 Kg = 56 Kg)

Kit completo di:

- 1 manovella
- 1 bussola da 17 mm
- 1 bussola da 19 mm
- 1 bussola da 21 mm

65931

 Valigetta / Case  5

CAR AND VANS TYRE-NUT WRENCH

Gear (1 Kg = 56 Kg)

Kit includes:

- 1 handle
- 1x17 mm socket
- 1x19 mm socket
- 1x21 mm socket

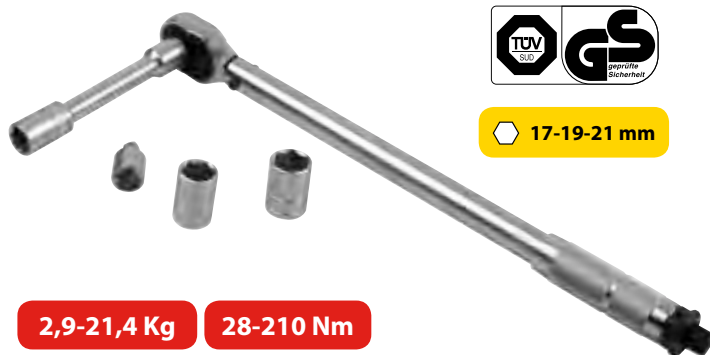
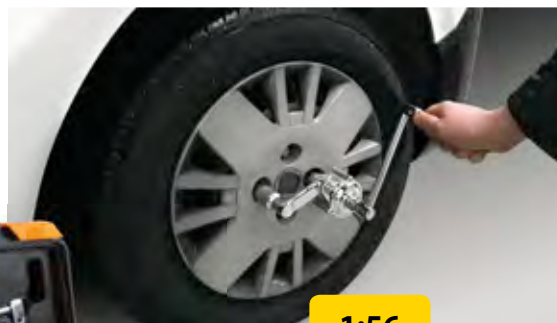
1:56

 17-19-21 mm

2,9-21,4 Kg
28-210 Nm
CHIAVE DINAMOMETRICA A SCATTO

Con cricchetto reversibile 1/2". Regolazione micrometrica da 2,9-21,4 Kg a 28-210 Nm. Il kit comprende: estensione da 120 mm, raccordo / adattatore, 3 chiavi bussola da 17, 19 e 21 mm

TORQUE WRENCH

1/2" drive micrometric. Adjustable torque wrench, 20".

With: 120 mm extension, adapter, 17-19-21 mm sockets

65930

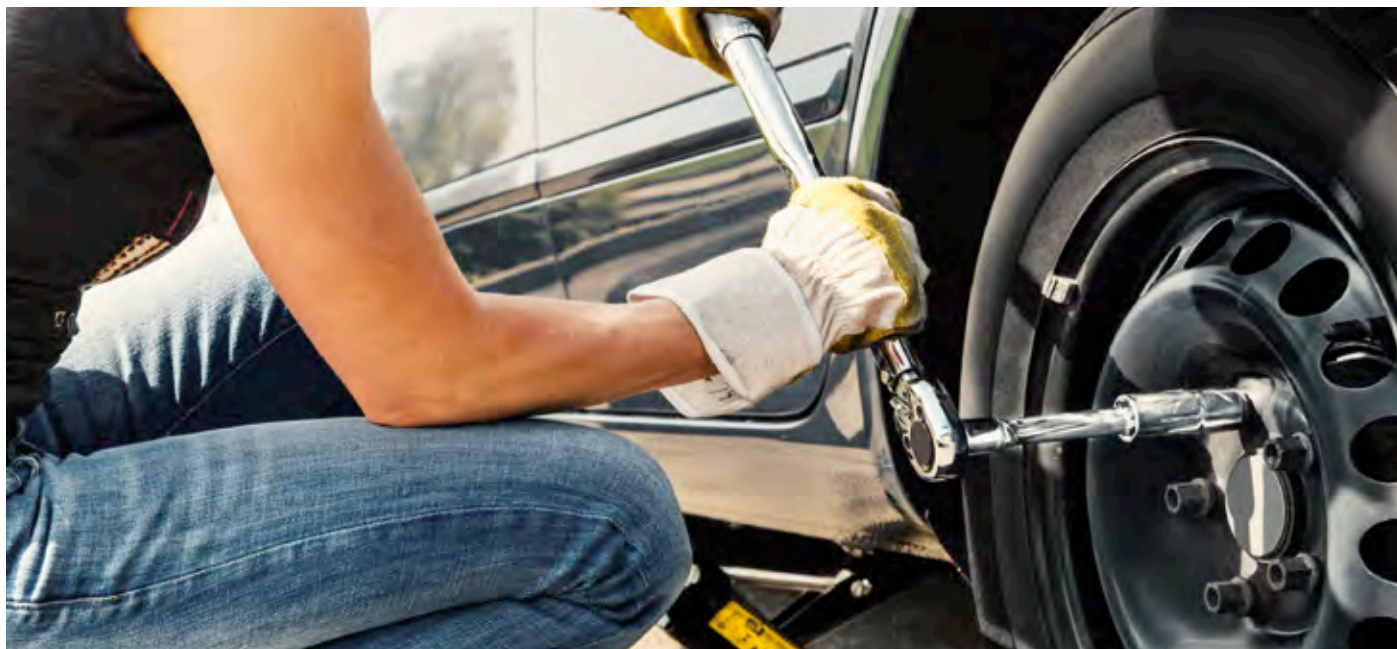
 Valigetta / Case  6

**MISURA PRESSIONE PNEUMATICI**

Professionale con custodia, pressione max 7 bar / 100 psi. Manometro Ø 50 mm.

PROFESSIONAL TYRE GAUGE

With plastic case, 50 mm Ø, max pressure 7 bar / 100 psi.

74000D/Blister  10 / 60**MISURA PRESSIONE PNEUMATICI IN GOMMA/METALLO**

Manometro da 40 mm. Pressione max 4,2 bar / 60 psi.

RUBBER/METAL TYRE GAUGE DIAL

40 mm diameter. Max pressure 4,2 bar / 60 psi.

74010D/Blister  10 / 200**PROVAPRESSIONE PNEUMATICI DIGITALE**

Altissima precisione, avvisatore sonoro, batteria al litio inclusa, autodisattivazione

DIGITAL TYRE PRESSURE GAUGE

Accurate digital LCD readings, self calibrating, auto shut-off, lithium battery included

74011Blister  12 / 120**MISURA PRESSIONE PNEUMATICI IN PLASTICA**

Pulsante azzeramento, di facile lettura, con quadrante a doppia scala.

PLASTIC TYRE PRESSURE GAUGE

Universal fitting, reset button, gauge with dual scale dial.

74012D/Blister  10 / 100**TUBO A SPIRALE CON RACCORDI**

Universale. Estensione massima 7,5 metri, max pressione 200 psi / 14 bar.

RE-COIL AIR HOSE

Universal. 7,5 metres long, max pressure 200 psi / 14 bar.

74002Busta / Bag  10 / 40**GONFIAPNEUMATICI DI PRECISIONE CON MANOMETRO 270°**

Rivestito in gomma antiurto.

TYRE INFLATOR WITH 270° GAUGE

Rubber coated.

73999D/Blister  10 / 40**PISTOLA GONFIAGGIO PNEUMATICI**

Con manometro di precisione e protezione antiurto in gomma.

HEAVY DUTY AIR INFLATOR GUN WITH GAUGE**74001**D/Blister  10 / 20**PISTOLA SOFFIAGGIO ARIA****AIR BLOW GUN****74003**D/Blister  10 / 100

**INIEZIONE DIRETTA
VALVE
THROUGH
SYSTEM**



Pump-Jet & Fix 12V Automatic

- Per pneumatici Tubeless.
- Ad iniezione diretta del liquido sigillante.
- Inietta il sigillante, ripara la foratura e gonfia lo pneumatico in un'unica operazione.
- Utilizzato senza sigillante, è un pratico compressore per gonfiaggio.
- Veloce, conveniente e facile da usare
- Ripara fori fino ad un massimo di \varnothing 5/6mm

- For all "Tubeless" tyres.
- Fast, convenient and easy.
- All in one DC 12V inflator with tyre sealant.
- Repairs maximum 5/6 mm puncture diameter.
- Sealant refill can be replaced after use



Compatibile con sistema TPMS - Compatible with TPMS system - (Tyre Pressure Monitoring System)

Standard

**PUMP-JET & FIX STANDARD,
KIT RIPARAZIONE PNEUMATICI, 12V
PUMP-JET & FIX STANDARD,
TYRE REPAIR SYSTEM, 12V**

72171

Scatola / Box 10



450 ml



Basic

**PUMP-JET & FIX BASIC,
KIT RIPARAZIONE PNEUMATICI, 12V
PUMP-JET & FIX BASIC,
TYRE REPAIR SYSTEM, 12V**

72170

Scatola / Box 8



450 ml



SIGIL-MATIC, KIT LIQUIDO SIGILLANTE PER PNEUMATICI

- Universale per tutti i compressori.
- È sufficiente utilizzare un buon compressore 12V per iniettare il sigillante, riparare la foratura e gonfiare lo pneumatico in una unica operazione.
- Ripara fori fino ad un massimo di 5 mm di diametro.

SIGIL-MATIC, SEALANT KIT FOR TUBELESS TIRES

- Universal for all good 12V compressors
- Fast, convenient and easy.
- For car, MPV, trailer and Motorcycle
- Repairs maximum 5 mm punctures diameter.

72173 300 ml Scatola / Box 12

72174 450 ml Scatola / Box 8

72175 600 ml Scatola / Box 10



Compatibile con sistema TPMS - Compatible with TPMS system - (Tyre Pressure Monitoring System)

**INIEZIONE MANUALE
MANUAL INJECTION**



Compatibile con sistema TPMS - Compatible with TPMS system
(Tyre Pressure Monitoring System)



TUBELESS

Pump & Go

PUMP & GO, KIT RIPARAZIONE PNEUMATICI

Per tutti i pneumatici tubeless. Ripara fori fino ad un massimo di Ø 5 mm. Composto da:

- Compressore 12 Volt 300 psi
- 500 ml di sigillante
- Accessori e istruzioni di utilizzo

72153

Scatola / Box 12

12V INFLATOR & TYRE SEALANT KIT

Repairs max 5 mm Ø holes.

Kit includes:

- 300 psi 12V compressor
- 500 ml bottle tyre sealant
- accessories and instruction manual



**RICAMBIO SIGILLANTE
TYRE SEALANT**

72154 500 ml

Film 15

**BICILINDRICO
TWIN CYLINDER**

**LUCE A LED
LED LIGHT**



**45 L/MIN
7 BAR
100 PSI**



**TWIN-AIR KIT,
COMPRESSORE BICILINDRICO, 12V - 200W**

- Alta capacità volumetrica, 45 l/min - Max 7 bar - 100 PSI
- Specifico per pneumatici ad alto contenuto di aria (fuoristrada, SUV, camper, furgoni).
- Universale, adatto per il gonfiaggio di tutti i pneumatici auto, moto, scooter e altri prodotti ad aria (palloncini, materassi...)
- Struttura metallica con cilindri (2x30 mm) e pistoni in lega di alluminio
- Manometro analogico in metallo
- Torcia a Led incorporata
- Con interruttore
- Collegamento tramite spinotto per presa accendisigari
- Cavo alimentazione da 250 cm
- Maniglia per il trasporto
- Tubo gonfiaggio da 70 cm con innesto a vite

**TWIN-AIR KIT,
TWIN-CYLINDER COMPRESSOR, 12V - 200W**

- High capacity, 45 l/min - Max 7 bar - 100 PSI
- Specific for large tires (off-road, RV, SUV, motorhomes, vans...) and universal for inflating any other smaller tyre or inflatable products (air mattresses, balls...)
- Metal housing with 2x30 mm alloy cylinder and pistons
- Metal pressure Gauge
- 250 cm cable with cigarette lighter plug.
- With Led light
- Metal foldable carry-handle
- 70 cm inflating hose with screw connector

72157

Scatola / Box 4



Borsa custodia in nylon
Nylon zip-bag for storage



Connettore batteria
Battery clips connector



Tubo prolunga a spirale
Spiral PU hose needle



Adattatori per gonfiabili
Adaptors



Compact



12V

250 psi
18 bar
15 l/min

COMPACT, COMPRESSORE 12V CON MANOMETRO

Presa accendisigari, potenza 250 psi (18 bar) 15 litri/min. In dotazione 2 adattatori per gonfiabili e ago gonfiapallonni

COMPACT, 12V AIR COMPRESSOR

250 psi (18 bar) 15 litre/minute. Two nozzle adaptors and one sport needle

72150

D/Blister 12



Air-Max



12V

150 psi
10 bar
35 l/min

AIR-MAX, COMPRESSORE 12V

Specifico per pneumatici di grandi dimensioni. Manometro, interruttore, collegamento alla presa accendisigari, cavo alimentazione da 3 metri. In dotazione 2 adattatori per gonfiabili e ago gonfiapallonni.

AIR-MAX, 12V AIR COMPRESSOR

Specific for large tires. Metal housing, pressure gauge and switch, 3 metres cable with cigarette lighter plug. Two nozzle adaptors and one sport needle

72152

Scatola / Box 6 / 12



Basic-Set



BASIC-SET, KIT RIPARAZIONE FORATURE PER PNEUMATICI TUBELESS

Il kit comprende: 1 pinza, 1 punteruolo per pulire ed allargare il foro da riparare, 1 sonda inserimento otturatore, 1 tubetto di mastice da 13gr, 5 otturatori, 1 cutter

BASIC-SET, TUBELESS TYRE REPAIR SET

The kit contains: 1 pliers, 1 t-handle reamer, 1 pluggger tool, 1 rubber cement 13gr, 5 plugs, 1 cutter

94259

D/Blister 10 / 100



Standard

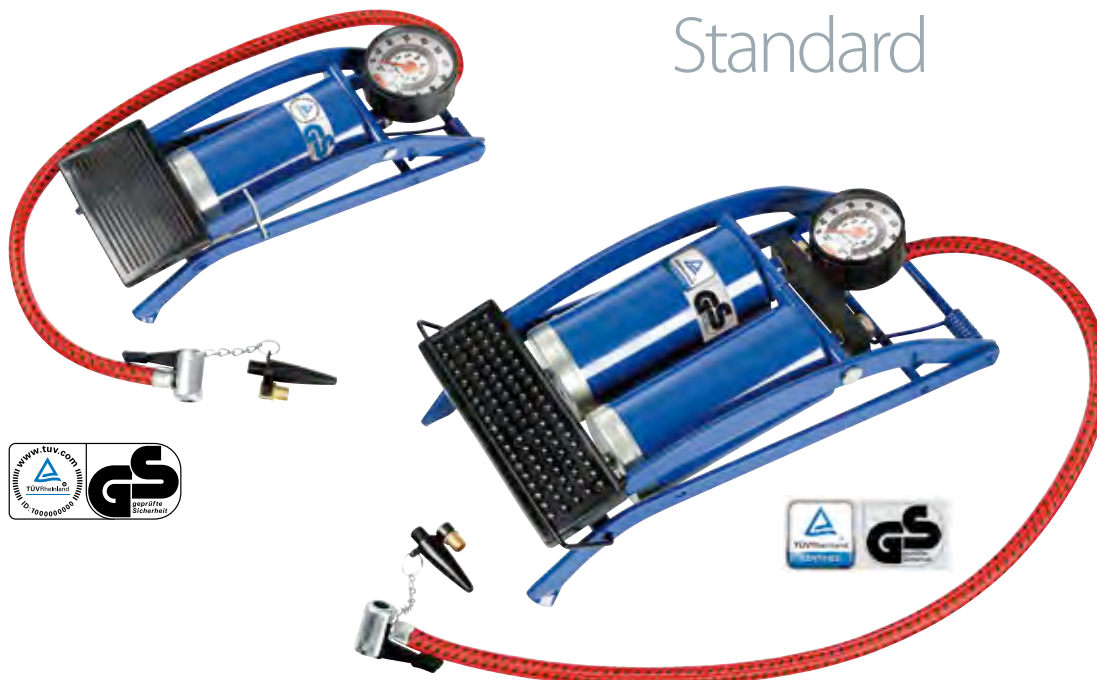

POMPA A PEDALE
 Cilindro in acciaio. Completa di raccordi ed adattatori.

FOOT PUMP
 Steel barrel. Supplied with adaptors and nozzle.

- 71600** 1 cilindro / cylinder
- 71610** 2 cilindri / cylinders

Scatola / Box 10

	71600	71610	
Cilindri	1	2	Cylinders
Misura cilindri	Ø 55x100 mm	Ø 50x120 mm	Barrel size
Manometro	270°		Manometer
Pressione max	7 bar		Max pressure
Lungh. tubo	45 cm	60 cm	Hose length
Volume aria (1 ciclo)	0,18 lt	0,40 lt	Air output (1 cycle)
Lungh. telaio	23 cm	29 cm	Frame length



De-Luxe



POMPA A PEDALE DE-LUXE
 Telaio trattato antiruggine e verniciato a caldo con vernice ad effetto martellato.

Completa di raccordi ed adattatori
HIGH QUALITY FOOT PUMP
 With manometer. Heavy duty metal frame. Supplied with adaptors and nozzle.

- 71605** 1 cilindro / cylinder
- 71611** 2 cilindri / cylinders

Scatola / Box 10

	71605	71611	
Cilindri	1	2	Cylinders
Misura cilindri	Ø 55x120 mm		Barrel size
Manometro	270°		Manometer
Pressione max	7 bar		Max pressure
Lungh. tubo	60 cm		Hose length
Volume aria (1 ciclo)	0,20 lt	0,40 lt	Air output (1 cycle)
Lungh. telaio	29 cm		Frame length





INDICATORE DI CARICA A LED PER BATTERIA, 12/24V
È sufficiente premere il tasto "on" per visualizzare lo stato di carica della batteria. Spegnimento automatico dopo 30 secondi di visualizzazione. Impermeabile IP65.

LED DISPLAY BATTERY INDICATOR, 12/24V
Analyses the battery status. Once installed, press the ON button to control the battery status in real-time. Automatic switch OFF after 30 seconds. IP65 waterproof.

90107

D/Blister 5 / 25



TESTER ANTIGELO PROFESSIONALE
Per i liquidi antigelo contenenti Glicol Etilenico.

ANTI FREEZE TESTER PROFESSIONAL TYPE
For all coolants containing Glycol Ethyl.

74080

D/Blister 10 / 90

TESTER ANTIGELO IN VETRO
Per i liquidi antigelo contenenti Glicol Etilenico.

ANTI FREEZE TESTER GLASS TYPE
For all coolants containing Glycol Ethyl.

74081

D/Blister 10 / 100



TESTER A LED PER BATTERIA 12V
Per diagnosi veloce della batteria, alternatore e regolatore di voltaggio

LED BATTERY AND ELECTRIC CIRCUIT TESTER

74060

Blister 12 / 144



DENSIMETRO PER BATTERIA
Tester pesa-acido per batterie

BATTERY DENSIMETER
Battery acid tester

74070

D/Blister 10 / 100



TESTER PER BATTERIA E ALTERNATORE, 12V
Analizza la carica delle batterie a 12V e verifica il corretto funzionamento dell'alternatore. Utilizzo semplice e rapido

BATTERY AND ALTERNATOR TESTER, 12V
Simple to use with clear LED indication showing the battery condition and correct operation of the alternator

74062

D/Blister 10 / 100



TESTER DI CARICA
Universale per pile da 1,5 a 9V. Con display a cristalli liquidi. Affidabile, facile da usare.

LCD BATTERY CHECKER
For 1,5V button cell and 9V batteries. LCD display

74067

D/Blister 6 / 36



TESTER 6/12V
Multiuso, adatto per individuare i fili con tensione

74065

D/Blister 12 / 288



PROTECTOR

Linea di prodotti per la protezione dell'auto, destinati a meccanici, gommisti e carrozzieri.

L'attività di quest'ultimi è costantemente a contatto con olio, grasso e quindi mani ed indumenti sporchi potrebbero danneggiare accidentalmente ed irrimediabilmente gli interni dell'auto.

E' perciò disponibile una linea in PE (polietilene) che comprende:

- Coprisedili
- Tappeti salvamoquettes
- Coprivolanti
- Copriruota
- Copriauto
- Kit 5 in 1
- Copriparafanghi in PVC

Car protection products for garages, tyre dealers & repairers and body shops.

These jobs imply a continuous contact with oil, grease, paint and other substance / powders which could damage irremediably the car interiors.

The new PE line is composed by:

- Seat protectors
- Paper floor protector
- Steering wheel covers
- Wheel covers
- Car covers
- Kit 5 in 1
- PVC Fender Cover



PROTEZIONE SEDILE IN PE, DISPENSER 100 PZ

A doppia tasca (sedile+schienale). LDPE bianco da 15 µm

PE SEAT PROTECTOR, 100 PCS DISPENSER

Double pocket (backrest+seat). 15 µm white LDPE

53000

Scatola / Box 4

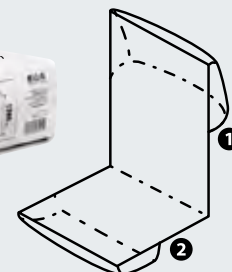
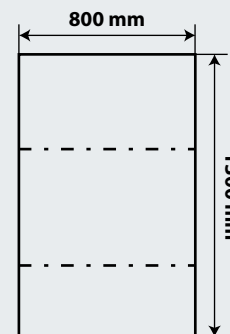

PROTEZIONE VOLANTE IN PE, DISPENSER 100 PZ

LDPE bianchio da 18 µm

PE STEERING WHEEL PROTECTOR, 100 PCS DISPENSER

18 µm white LDPE

53003

Scatola / Box 2





PROTEZIONE MOQUETTE IN CARTA, DISPENSER 200 PZ
 Carta bianca laminata PE
PAPER MOQUETTE PROTECTOR, 200 PCS DISPENSER
 White PE coating

53001

Scatola / Box ☐ 1

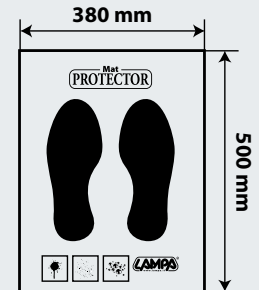

PROTEZIONE RUOTA IN PE, DISPENSER 200 PZ
 LDPE bianco da 15 µm
PE WHEEL PROTECTOR, 200 PCS DISPENSER
 15 µm white LDPE

53002

Scatola / Box ☐ 2

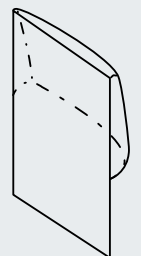
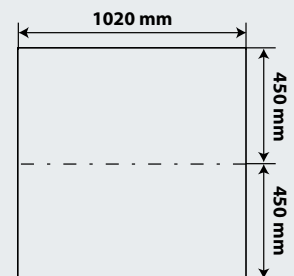

KIT DI PROTEZIONE 5 IN 1

Contenuto:

- 1 coprivolante in polietilene
- 1 coprisedile in polietilene
- 1 copripomello in polietilene
- 1 copri leva freno in polietilene
- 1 tappetino in carta

PROTECTOR KIT (5PCS IN 1)

It contains:

- 1 steering wheel cover
- 1 disposal seat cover
- 1 disposal gear shift cover
- 1 disposal hand brake cover
- 1 disposal paper footmat

53007

Busta / Bag ☐ 100





COPRIAUTO IMPERMEABILE IN PE TRASPARENTE

Spessore: 30 µm

WATERPROOF CAR COVER IN CLEAR PE

Thickness: 30µm.

53004	S	6 x 3,5 m
53005	M	6,6 x 3,8 m
53006	L	7,5 x 4,8 m



Busta / Bag 20

COPRIPARAFANGO IN PVC

Termosaldato ad un tessuto floccato e corredato di n. 2 calamite per fissarlo alla carrozzeria della vettura.

FENDER COVER IN PVC

Coupled with a thermo-flocked material, equipped with 2 magnets for the adherence to the car body.

53008

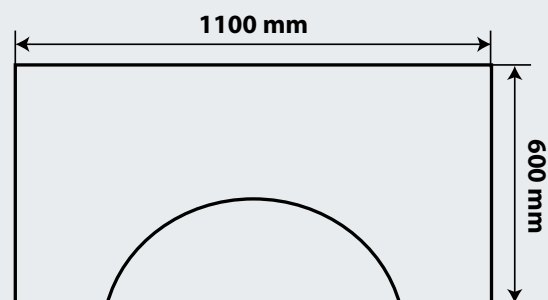

Copriauto Car covers

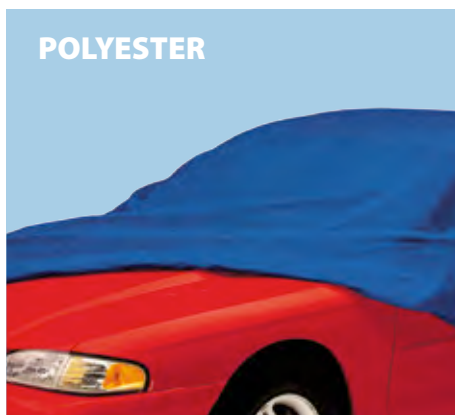
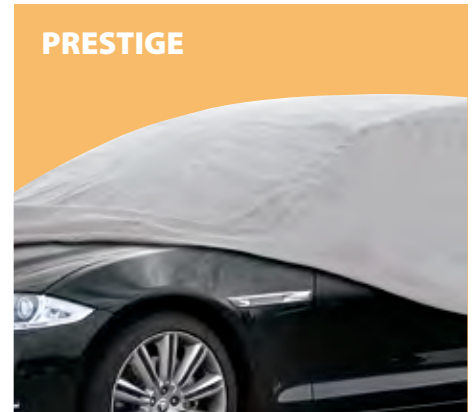
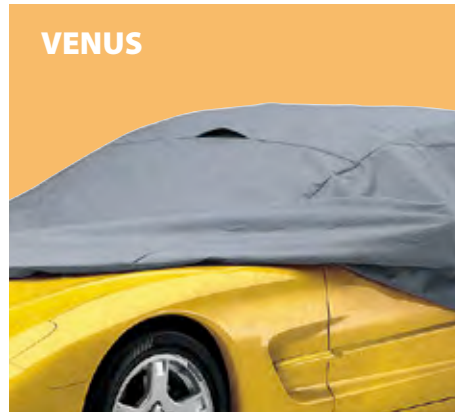



Meteo-Max 2

Foglio da 5 mm in EVA espanso accoppiato con Poliestere (150 denari) + fodera in tessuto non tessuto antigraffio con caratteristiche di lunga durata. I copriauto vengono dotati di aeratori per garantire il ricircolo d'aria. Impermeabile. Ottima protezione contro raggi UV e polvere.

A special layer of 5 mm EVA foam material with Polyester (150 denier) + internally a soft non-woven textile to protect paint from scratches. Cover comes with air vents to help inside air ventilation keeping car cool. Waterproof. Good protection against UV sunrays and dust.



Venus

Foglio da 0,18 mm in PVC, accoppiato con "tessuto non tessuto" in Polipropilene, con caratteristiche di durata, 100% impermeabilità e leggerezza. I copriauto vengono dotati di aeratori per garantire il ricircolo d'aria. Le cuciture ad ultrasuoni non lasciano penetrare l'acqua e mantengono la vettura sempre asciutta e fresca

0.18mm thickness vinyl sheet laminated with light-weighted Polypropylene non-woven lining provides features of 100% waterproof, light-weight and durability. Cover comes with air vents to help inside air ventilation plus ultrasonically welding seams preventing water penetrates through seams, keeping car inside always dry and cool.

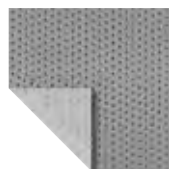

Prestige

Speciale tessuto a 5 strati di Polipropilene, con caratteristiche di lunga durata. Spessore 0,24 mm. Altissima resistenza all'acqua e traspirante con buon ricircolo d'aria. Le cuciture ad ultrasuoni non lasciano penetrare l'acqua e mantengono la vettura sempre asciutta e fresca. Ottima protezione contro la polvere e contro raggi UV tramite trattamento anti-UV "Remafin LSP 348" (sviluppato in Germania). Peso 210 g/m².

5 layers fabric by Polyproline paste provides features of lightweight and water repellent. Thickness 0,24mm. High water resistance and breathable are keeping car inside always dry and cool. Ultrasonic welding seals seams tight. Patented UV stabilizer "Remafin LSP 348" (developed in Germany) is used to ensure a long life.

Dust protection. Fabric weight: 210 grams per square meter.



Polyester & Umbrella

Taffeta in poliestere 68 Denari laminato con pasta in poliuretano. Ultra-leggero, protegge da polvere ed acqua (idrorepellente). Rimane morbido e flessibile in tutte le condizioni climatiche, dal ghiaccio al caldo torrido.

Very light-weight 100% Polyester 68D. Taffeta coated by Poly Urethane paste provides features of light-weight, dust and water resistance and remains flexibility under snow-cold and sun-hot climates.



Saturn

2 strati di "tessuto non tessuto" in Polipropilene, uniti con una pasta speciale che li rende 100% impermeabili e di basso peso specifico. I copriauto vengono dotati di aeratori per garantire il ricircolo d'aria.

Le cuciture ad ultrasuoni non lasciano penetrare l'acqua e mantengono la vettura sempre asciutta e fresca. Peso 125 g/m²

2-layer Polypropylene non-woven fabrics bonded by Polyethylene paste provides features of light-weight and 100% waterproof. Cover comes with air vents to help inside air ventilation plus ultrasonically welding seams preventing water penetrates through seams, keeping car inside always dry and cool. Fabric weight: 125 grams per square metre.



4 Stagioni

Strato di PEV 145 gr/m² accoppiato con una morbida felpatura in "tessuto non tessuto" di poliestere per proteggere la verniciatura della carrozzeria. Ottime caratteristiche di durata, 100% impermeabilità, leggerezza e ottima resistenza ai raggi UV. Lo speciale materiale in PEVA permette la realizzazione del copriauto utilizzando saldature ad ultrasuoni, senza cuciture a filo.

145 gr/m² thick PEVA sheet laminated with soft polyester non-woven plush to protect car paint, providing features of 100% waterproof, light-weight and durability, with high resistance to UV. PEVA material allows ultrasonic welding seal seams without any stitching.



Stretch-Fit

Tessuto in poliestere elasticizzato a lunga durata con interno in morbido tessuto antigraffio. Spessore 0,20mm. Non impermeabile, ma traspirante con buon ricircolo d'aria. Ottima protezione contro la polvere e contro i raggi UV. Bordatura rinforzata sul fronte e sul retro per una perfetta aderenza al veicolo. Borsa contenitiva inclusa. Peso 170 g/m².

Very light-weight 100% polyester knitting stretch fabric with soft fleece inner lining which provide features of durability. Thickness 0,20mm. It is not waterproof but it is breathable, keeping car inside always dry and cool. Good protection against UV sunrays and dust. Storage bag included. Fabric weight: 170 grams per square meter.

	IMPERMEABILITÀ WATER RESISTANCE	ROBUSTEZZA STRENGTH	PROTEZIONE TERMICA HEAT PROTECTION	PROTEZIONE CARROZZERIA CAR PROTECTION	TRASPIRAZIONE BREATH ABILITY
METEO MAX 2	★★★★★	★★★★★	★★★★★	★★★★★	★★ con aeratori - with air-vent
VENUS	★★★★★	★★★★	★★	★★★★	★★★ con aeratori - with air-vent
PRESTIGE	★★★	★★★★★	★★★★★	★★★★★	★★★ con aeratori - with air-vent
POLYESTER	★★	★★	★★	★★	★★
UMBRELLA	★	★★	★★	★★	★
SATURN	★★★	★★★	★★★★★	★★★★	★★★ con aeratori - with air-vent
4 STAGIONI	★★★★★	★★★	★★	★★★★	★★★★
STRETCH-FIT		★★★	★	★★★★	★★★★★

Legenda Icone Icons Legend



Protegge dai Raggi Uv
Uv Stabilized



Impermeabile
Waterproof



Idrorepellente
Water resistant



Tessuto Elasticizzato
Stretch-Fit Polyester



Antigraffine
Anti-Hail



Antimuffa e Antiumidità
Resist Rot and Mildew



Traspirante
Breathable



Lavabile in Lavatrice
Machine Washable



Zip Multiple
Multi Zip

METEO MAX-2

ANTIGRANDINE
ANTI-HAIL
IMPERMEABILE
WATERPROOF



IDROPELLENTE
WATER RESISTANT

**CON AERATORI
with air outlets**

Gli speciali aeratori brevettati assicurano una buona ventilazione

PROTEZIONE

5 mm Spessore

Antigrandine Hailstones protection



METEO-MAX 2, COPRIAUTO CON PROTEZIONE ANTIGRANDINE
Uno speciale strato di 5 mm di EVA espanso (Etilene Vinil Acetato) copre e protegge da eventi atmosferici e chicchi di grandine fino ad un diametro di 12 mm con velocità di caduta fino a 70 Km/h. Resistente all'acqua e traspirante. Fasce laterali in poliestere atermico. Foderato internamente con un morbido tessuto-non-tessuto antigraffio. Bordature anteriori e posteriori elasticizzate. 2 cinghie sottoscocca per fissare il copriauto e resistere a raffiche di vento. Inserti riflettenti sui 4 lati. Custodia in dotazione

METEO-MAX 2, HAILSTONES PROTECTION CAR COVER
A special 5 mm EVA foam (Ethylene Vinyl Acetate) material is used to cover and protect to withstand hail up to 12 mm ice diameter with a falling speed of max 70 km/h. Protection in any climate conditions, sun, rain, smog, dust great also to protect car from falling objects such as pine-cones, chestnuts, husks... The EVA layer is lined with a soft non-woven textile to protect vehicle paint from scratches. Water resistant and breathable, with strong tear & wear resistance. Front and rear elasticized bottom hems. 2 underbody straps to secure cover onto car and withstand strong winds

Busta / Bag 1



TIPO VETTURA CAR TYPE	MIS. SIZE	ART.	LUNGH. LENGHT	LARGH. WIDTH	ALTEZZA HEIGHT
	AG-1	20550	400	170	160
	AG-2	20551	460	180	150
	AG-3	20552	535	205	150
	AG-4	20553	450	180	160
	AG-5	20554	495	185	155
	AG-6	20555	440	190	180
	AG-7	20556	485	193	190
	AG-8	20549	510	200	190

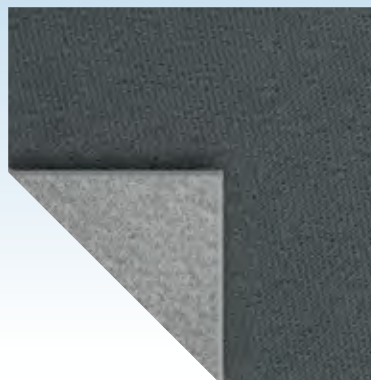

Venus



VENUS, COPRIAUTO

In PVC elettrosaldato, impermeabile. Protegge dai raggi solari UV. Con aeratori. Accoppiato internamente con tessuto non tessuto, completo di: bordatura elasticizzata per un montaggio ottimale, custodia.

VENUS CAR COVER

High-resistance PVC with non woven fibre. Waterproof. Protects against UV rays.

With air outlets. Supplied with elastic bands and air outlets

Scatola / Box 2

**CON AERATORI
with air outlets**



Gli speciali aeratori brevettati assicurano una buona ventilazione

Foglio in pvc pvc sheet

Tessuto non tessuto Non-woven fibre



Prestige

TRATTAMENTO ANTI UV TRAMITE "REMAFIN LSP 348" SVILUPPATO IN GERMANIA



PRESTIGE, COPRIAUTO

Speciale tessuto a 5 strati con morbida felpatura rasata. Impermeabile e traspirante. Resistente alla muffa. Saldature ad ultrasuoni. Trattamento anti-UV. Con cinghia di fissaggio e custodia

PRESTIGE, CAR COVER

5 layers fabric is fleece lined. Waterproof, and breathable. Ultrasonic welding seals seams tight. Patented UV. Tie down strap. Cover included

Scatola / Box 2

TESSUTO A 5 STRATI - 5 LAYERS FABRIC



	TIPO VETTURA CAR TYPE	MIS. SIZE	ART.	LUNGH. LENGHT	LARGH. WIDTH	ALTEZZA HEIGHT
A		02	20360	270	154	155
		04	20361	310	135	135
B		06	20362	328	152	145
		08	20363	350	150	150
		10	20364	362	163	150
		12	20365	390	170	155
		14	20366	395	170	165
C		16	20367	420	170	140
		18	20368	435	178	145
		20	20369	457	180	150
		22	20370	475	187	150
		24	20371	489	186	155
D		26	20372	409	178	155
		28	20373	424	177	150
		30	20374	442	178	157
E		36	20377	525	190	150
		38	20378	535	206	148
F		32	20375	480	180	155
		34	20376	450	180	150
		40	20379	490	185	155
G		44	20381	389	179	170
		56	20387	358	162	165
		58	20388	384	176	166
H		46	20382	415	175	178
		48	20383	440	190	190
		60	20389	420	180	175
I		62	20390	450	180	168
		68	20393	480	185	173
L		50	20384	485	193	190
		52	20385	510	200	190

	TIPO VETTURA CAR TYPE	MIS. SIZE	ART.	LUNGH. LENGHT	LARGH. WIDTH	ALTEZZA HEIGHT
A		02	20557	270	154	155
		04	20558	310	135	135
B		06	20559	328	152	145
		08	20560	350	150	150
		10	20561	362	163	150
		12	20562	390	170	155
		14	20563	395	170	165
C		16	20564	420	170	140
		18	20565	435	178	145
		20	20566	457	180	150
		22	20567	475	187	150
		24	20568	489	186	155
D		26	20569	409	178	155
		28	20570	424	177	150
		30	20571	442	178	157
E		36	20574	525	190	150
		38	20575	535	206	148
F		32	20572	480	180	155
		34	20573	450	180	150
		40	20576	490	185	155
G		44	20577	389	179	170
		56	20582	358	162	165
		58	20583	384	176	166
H		46	20578	415	175	178
		48	20579	440	190	190
		60	20584	420	180	175
I		62	20585	450	180	168
		68	20586	480	185	173
L		50	20580	485	193	190
		52	20581	510	200	190

Polyester



COPRIAUTO POLIESTERE

Idrorepellente. Bordi elasticizzati anteriori e posteriori. Con gancio antifurto. Installazione semplice e veloce, è sufficiente una persona. Completo di borsa custodia

POLYESTER CAR COVER

Water resistant, double-stitched seams, heavy duty elastic hems. One person operation. Ultra durable light weight material keeps car cooler, paint from fading and grime off the car



D/Blister 6



PRATICO E VELOCE
Una sola persona può applicare il copriauto in meno di 30 secondi



Saturn



TRATTAMENTO ANTI UV TRAMITE "REMAFIN LSP 348" SVILUPPATO IN GERMANIA

SATURN, COPRIAUTO

Tessuto speciale ad alta resistenza, ultraleggero, impermeabile al 100%. Adatto anche per climi umidi e ghiacciati. Resistente all'umidità: non marcisce nè ammuffisce. Protetto contro i raggi U.V. grazie allo stabilizzatore Ramafin LSP 348. Saldature ad ultrasuoni. La bordatura elasticizzata permette di mantenere il copriauto in posizione anche con vento.

Gli anelli posizionati sui lati sono rinforzati e permettono di applicare una eventuale cintura sottoscocca

SATURN CAR COVER

100% Waterproof material, exclusive air ventilation system, ultrasonic welding seals seams while exclusive patented vents allows cover to "breath"

Scatola / Box 2

CON AERATORI with air outlets



Gli speciali aeratori brevettati assicurano una buona ventilazione

TYBOND™
Ultraleggero

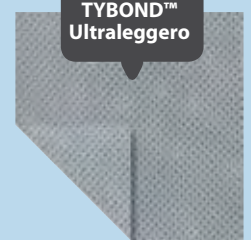

	TIPO VETTURA CAR TYPE	MIS. SIZE	ART.	LUNGH. LENGHT	LARGH. WIDTH	ALTEZZA HEIGHT
A		01	20301	270	154	155
B		03	20302	390	170	155
		05	20303	395	170	165
C		11	20306	457	180	150
		13	20307	489	186	155
D		07	20304	424	177	150
		09	20305	442	178	157
E		15	20308	535	206	148
F		17	20309	450	180	150
		19	20311	490	185	155
G		25	20314	358	162	165
		29	20316	384	176	166
H		23	20313	440	190	190
		27	20315	430	200	200
I		35	20319	480	185	173
L		31	20317	485	193	190
		39	20322	510	200	190

	TIPO VETTURA CAR TYPE	MIS. SIZE	ART.	LUNGH. LENGHT	LARGH. WIDTH	ALTEZZA HEIGHT
A		01	20181	270	154	155
B		03	20182	390	170	155
		05	20183	395	170	165
C		11	20186	457	180	150
		13	20187	489	186	155
D		07	20184	424	177	150
		09	20185	442	178	157
E		15	20188	535	206	148
F		17	20189	450	180	150
		19	20190	490	185	155
G		25	20193	358	162	165
		29	20195	384	176	166
H		23	20192	440	190	190
		27	20194	430	200	200
I		35	20198	480	185	173
L		31	20196	485	193	190
		39	20200	510	200	190

4 Stagioni Seasons

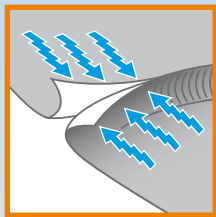

Le saldature ad ultrasuoni sigillano ermeticamente le cuciture
Ultrasonic welding seals seams tight

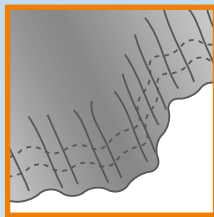

La bordatura elasticizzata anteriore e posteriore permette di avvolgere l'auto e di mantenere il copriauto in posizione anche con il vento
Heavy duty elastic hems at front and rear provides for a secure fit

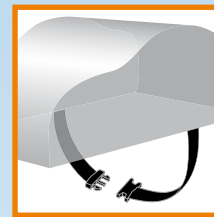

Completo di cintura sottoscocca
Includes underbody fastening strap with buckle

4 STAGIONI, COPRIAUTO IN PEVA ELETTRISALDATO

- Accoppiato internamente con felpa in poliestere
- Saldature ad ultrasuoni per sigillare le cuciture e per mantenere l'acqua e l'umidità all'esterno
- Bordatura anteriore e posteriore elasticizzata per un facile montaggio
- Protegge dai raggi solari UV
- Tessuto morbido, non graffia, 100% impermeabile
- Completo di cintura sottoscocca

4 SEASONS, PEVA WATERPROOF CAR COVER

- Ultrasonic welding seals seams and keeps water out
- Elastic front and rear hems
- Super soft, non abrasive fabric, 100% waterproof
- Includes underbody fastening strap with buckle
- Protects against UV rays

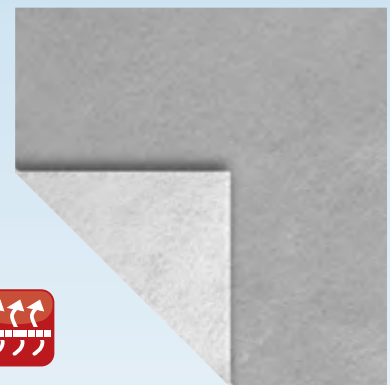

Busta / Bag 4



TIPO VETTURA CARTYPE	MIS. SIZE	ART.	LUNGH. LENGHT	LARGH. WIDTH	ALTEZZA HEIGHT
	AG-1	20455	400	170	160
	AG-2	20456	460	180	150
	AG-3	20457	535	205	150
	AG-4	20458	450	180	160
	AG-5	20459	495	185	155
	AG-6	20460	440	190	180
	AG-7	20461	485	193	190
	AG-8	20462	510	200	190

Stretch-Fit Professional



STRETCH-FIT PROFESSIONAL, COPRIAUTO DI QUALITÀ SUPERIORE

Tessuto di poliestere elasticizzato e felpato al suo interno, per proteggere la vettura da graffi, polvere e raggi UV. Realizzato per proteggere l'auto anche quando è al coperto. Traspirante, resistente alle muffe e all'umidità, lavabile in lavatrice

STRETCH-FIT PROFESSIONAL, HIGH GRADED CAR COVER

With soft fleecy inner lining to protect vehicle from scratches, dust and from UV rays.

Scatola / Box 2



Tessuto Elasticizzato morbidamente felpato al suo interno
NON IMPERMEABILE NOT WATERPROOF



TIPO VETTURA CAR TYPE	MIS. SIZE	ART.	LUNGHEZZA cm LENGHT cm
	CS-1	20105	->340
	CS-2	20106	340->380
	CS-3	20107	380->390
	CS-4	20108	390->420
	CS-5	20109	420->460
	CS-6	20110	460->490
	CS-7	20111	490->530

Umbrella



UMBRELLA, COPRITETTO/CRISTALLI

Prodotto con tessuto di poliestere antistrappo. Alta resistenza in tutte le condizioni climatiche. Doppie cuciture antistrappo. Completo di elastici per un solido fissaggio a prova di vento.

UMBRELLA TOP-COVER

Supplied with fitting strap for a secure fit. Quick and easy

Scatola / Box 10

PROTEZIONE ESTIVA E INVERNALE LEGGERA E RESISTENTE

ESTATE: protegge gli interni dell'auto dai raggi solari UV mantenendo l'abitacolo più fresco

INVERNO: previene il formarsi di rugiada e brina sui cristalli o di accumuli di neve (niente più raschiaghiaccio, spazzole neve...)

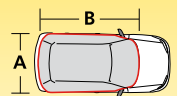

	TIPO VETTURA CAR TYPE	MIS. SIZE	ART.	PERIMETRO MAX (m) MAX PERIMETER (m) (A+B)x2
B		S	20113	≤ 8,42 m
D		M	20114	≤ 8,83 m
E		L	20115	≤ 9,13 m
F		SW-M	20116	≤ 9,82 m
		SW-L	20117	≤ 10,51 m
I		MPV-M	20118	≤ 10,35 m

Modello Auto Car Model	Anno Year	VENUS PRESTIGE	SATURN POLYESTER	METEO-MAX 4 STAGIONI	STRETCH-FIT	UMBRELLA
ABARTH						
124 Spider	09/16>	26	07	AG-2	CS-5	
500	07/08>05/16	10	03	AG-1	CS-2	S
500C	06/10>05/16	10	03	AG-1	CS-2	S
695 Biposto	12/14>	10	03	AG-1	CS-2	S
Punto 3p	05/08>06/11	12	03	AG-1	CS-3	M
Punto Evo 3p	06/10>04/12	12	03	AG-1	CS-3	M
ALFA ROMEO						
145	07/94>12/00	26	07	AG-4	CS-5	L
146	12/94>12/00	18	11	AG-2	CS-5	L
147 3p	10/00>08/08	28	07	AG-4	CS-5	L
147 5p	04/01>08/08	28	07	AG-4	CS-5	L
155	01/92>12/97	20	11	AG-2	CS-5	L
156 4p	10/97>12/07	20	11	AG-2	CS-5	L
156 Crosswagon	10/04>12/07	34	17	AG-5	CS-5	SW-L
156 Sportwagon	03/00>12/07	34	17	AG-5	CS-5	SW-L
159 4p	08/05>09/13	24	13	AG-3	CS-6	L
159 Sportwagon	03/06>09/13	32	19	AG-5	CS-6	SW-L
164	09/87>10/98	24	13	AG-3	CS-6	L
166	06/98>05/04	24	13	AG-3	CS-6	L
33	07/83>10/95	26	07	AG-1	CS-4	L
4C	11/13>	08	03	AG-1	CS-1	M
75	06/85>12/94	18	11	AG-4	CS-5	M
90	01/84>12/88	30	09	AG-4	CS-5	M
Alfetta	01/75>12/85	28	07	AG-4	CS-4	M
Brera	01/06>07/11	30	09	AG-4	CS-5	SW-L
Giulia	06/16>	22	13	AG-2	CS-6	SW-L
Giulietta	04/10>	30	09	AG-4	CS-5	SW-L
GT	12/03>03/11	20	11	AG-2	CS-5	M
GTV	03/95>01/06	18	11	AG-2	CS-5	L
Mito	09/08>	26	07	AG-4	CS-4	L
Spider	01/86>09/95	18	11	AG-2	CS-5	L
Spider	10/95>05/06	18	11	AG-2	CS-5	L
Spider	06/06>06/11	20	11	AG-2	CS-5	M
AUDI						
A1 3p	09/10>	26	07	AG-4	CS-4	L
A1 Sportback 5p	02/12>	26	07	AG-4	CS-4	L
A2 5p	07/00>08/05	14	05	AG-1	CS-4	M
A3 3p	09/96>04/03	28	07	AG-4	CS-5	L
A3 3p	05/03>08/12	28	07	AG-4	CS-5	L
A3 3p	09/12>	28	07	AG-4	CS-5	L
A3 Cabriolet	04/08>02/14	28	07	AG-4	CS-5	SW-M
A3 Cabriolet	03/14>	32	19	AG-5	CS-6	SW-L
A3 Sedan 4p	09/13>	20	11	AG-2	CS-5	L
A3 Sportback 5p	09/96>08/04	30	09	AG-4	CS-5	SW-M
A3 Sportback 5p	09/04>10/12	30	09	AG-4	CS-5	SW-M
A3 Sportback 5p	11/12>	30	09	AG-4	CS-5	SW-M
A4 4p	11/94>12/00	20	11	AG-2	CS-5	L
A4 4p	01/01>10/07	20	11	AG-2	CS-5	L
A4 4p	11/07>10/15	22	13	AG-3	CS-6	L
A4 4p	11/15>	22	13	AG-3	CS-6	L
A4 Allroad	04/09>05/16	32	19	AG-5	CS-6	SW-L
A4 Allroad	06/16>	32	19	AG-5	CS-6	SW-L
A4 Avant	11/95>08/01	32	19	AG-5	CS-6	SW-L
A4 Avant	09/01>04/08	32	19	AG-5	CS-6	SW-L
A4 Avant	05/08>10/15	32	19	AG-5	CS-6	SW-L
A4 Avant	11/15>	32	19	AG-5	CS-6	SW-L
A4 Cabrio	05/02>03/08	20	11	AG-2	CS-5	L
A5 Cabrio	03/09>	22	13	AG-3	CS-6	L
A5 Coupè 2p	06/07>08/16	22	13	AG-3	CS-6	L
A5 Coupè 2p	09/16>	22	13	AG-3	CS-6	L

Modello Auto Car Model	Anno Year	VENUS PRESTIGE	SATURN POLYESTER	METEO-MAX	STRETCH-FIT	UMBRELLA
A5 Sportback 5p	09/09>07/15	22	13	AG-3	CS-6	L
A6 4p	07/97>08/04	24	13	AG-3	CS-6	L
A6 4p	09/04>03/11	24	13	AG-3	CS-6	L
A6 4p	04/11>	36	15	AG-3	CS-7	L
A6 Allroad	06/06>02/12	40	19	AG-5	CS-6	SW-L
A6 Allroad	03/12>	40	19	AG-5	CS-6	SW-L
A6 Avant	08/94>07/97	40	19	AG-5	CS-6	SW-L
A6 Avant	08/97>02/05	40	19	AG-5	CS-6	SW-L
A6 Avant	03/05>08/11	40	19	AG-5	CS-6	SW-L
A6 Avant	09/11>	40	19	AG-5	CS-6	SW-L
A7	10/10>	36	15	AG-3	CS-7	L
A8	01/94>10/02	36	15	AG-3	CS-7	L
A8	11/02>02/10	36	15	AG-3	CS-7	L
A8	03/10>	36	15	AG-3	CS-7	L
Allroad	06/00>05/06	40	19	AG-5	CS-6	SW-L
Q2	11/16>	60	23	AG-6	CS-4	MPV-M
Q3	10/11>	48	23	AG-6	CS-5	MPV-M
Q5	11/08>	68	35	AG-7	CS-6	MPV-M
Q7	03/06>05/15	52	39	AG-8	CS-7	MPV-M
Q7	06/15>	52	39	AG-8	CS-7	MPV-M
R8	04/07>05/15	18	11	AG-2	CS-5	M
R8	06/15>	20	11	AG-2	CS-5	L
R8 Spyder	04/07>09/15	18	11	AG-2	CS-5	M
R8 Spyder	10/15>	20	11	AG-2	CS-5	M
TT Coupè 2p	11/98>09/03	18	11	AG-2	CS-5	M
TT Coupè 2p	10/03>08/06	18	11	AG-2	CS-5	M
TT Coupè 2p	09/06>09/14	18	11	AG-2	CS-5	M
TT Coupè 2p	10/14>	18	11	AG-2	CS-5	M
TT Roadster 2p	03/99>09/03	18	11	AG-2	CS-5	M
TT Roadster 2p	10/03>02/07	18	11	AG-2	CS-5	M
TT Roadster 2p	03/07>09/14	18	11	AG-2	CS-5	M
TT Roadster 2p	10/14>	18	11	AG-2	CS-5	M
AUTOBIANCHI						
Y10	03/85>12/95	08	03	AG-1	CS-1	M
BMW						
i3 (i03)	11/13>	26	07	AG-1	CS-4	M
i8 (i12)	04/14>	22	13	AG-3	CS-6	L
Serie 1 (E81) 3p	03/07>06/12	28	07	AG-4	CS-5	SW-M
Serie 1 (E87) 5p	09/04>08/11	30	09	AG-4	CS-5	SW-M
Serie 1 (F20) 5p	09/11>	30	09	AG-4	CS-5	SW-L
Serie 1 (F21) 3p	07/12>	30	09	AG-4	CS-5	SW-L
Serie 1 Cabrio (E88)	03/08>09/11	18	11	AG-2	CS-5	M
Serie 1 Coupè (E82) 2p	09/07>12/13	18	11	AG-2	CS-5	M
Serie 2 Active Tourer (F45) 5p	09/14>	34	17	AG-4	CS-5	SW-L
Serie 2 Cabrio (F22)	02/15>	20	11	AG-2	CS-5	L
Serie 2 Coupè (F22) 2p	03/14>	20	11	AG-2	CS-5	L
Serie 2 Gran Tourer 5p	05/15>	68	35	AG-5	CS-5	SW-L
Serie 3 (E36) 4p	10/90>02/98	20	11	AG-2	CS-5	L
Serie 3 (E46) 4p	03/98>02/05	20	11	AG-2	CS-5	L
Serie 3 (E90) 4p	03/05>01/12	20	11	AG-2	CS-5	L
Serie 3 (F30) 4p	02/12>	22	13	AG-3	CS-6	L
Serie 3 Cabrio (E93)	03/07>12/13	22	13	AG-3	CS-6	L
Serie 3 Compact (E36) 2p	08/94>05/00	22	13	AG-3	CS-6	M
Serie 3 Compact (E46) 2p	06/00>12/05	18	07	AG-2	CS-5	M
Serie 3 Coupè (E36) 2p	04/92>03/99	22	13	AG-3	CS-6	M
Serie 3 Coupè (E46) 2p	04/99>08/06	22	13	AG-3	CS-6	M
Serie 3 Coupè (E92) 2p	09/06>12/13	22	13	AG-3	CS-6	L
Serie 3 Gran Turismo (F34) 4p	04/13>	40	19	AG-5	CS-6	SW-L
Serie 3 Touring (E36)	08/94>08/99	32	19	AG-5	CS-6	SW-L

Modello Auto Car Model	Anno Year						VENUS PRESTIGE	SATURN POLYESTER	METEO-MAX 4 STAGIONI	STRETCH-FIT	UMBRELLA
		VENUS PRESTIGE	SATURN POLYESTER	METEO-MAX 4 STAGIONI	STRETCH-FIT	UMBRELLA					
Serie 3 Touring (E46)	09/99>08/05	32	19	AG-5	CS-6	SW-L					
Serie 3 Touring (E91)	09/05>05/12	32	19	AG-5	CS-6	SW-L					
Serie 3 Touring (F31)	06/12>	32	19	AG-5	CS-6	SW-L					
Serie 4 Cabrio (F33)	03/14>	22	13	AG-3	CS-6	L					
Serie 4 Coupè (F32)	10/13>	22	13	AG-3	CS-6	L					
Serie 4 Grand Coupè (F36)	04/14>	22	13	AG-3	CS-6	L					
Serie 5 (E39) 4p	09/95>06/03	24	13	AG-3	CS-6	L					
Serie 5 (E60) 4p	07/03>12/09	24	13	AG-3	CS-6	L					
Serie 5 (F10) 4p	01/10>	24	13	AG-3	CS-6	L					
Serie 5 Gran Turismo (F07) 4p	09/09>	36	15	AG-3	CS-7	L					
Serie 5 Touring (E39)	04/97>03/04	40	19	AG-5	CS-6	SW-L					
Serie 5 Touring (E61)	04/04>05/10	40	19	AG-5	CS-6	SW-L					
Serie 5 Touring (F11)	06/10>	40	19	AG-5	CS-6	SW-L					
Serie 6 Cabrio (E64)	04/04>02/11	24	13	AG-3	CS-6	L					
Serie 6 Cabrio (F13)	03/11>	24	13	AG-3	CS-6	L					
Serie 6 Coupè (E63) 2p	01/04>06/11	24	13	AG-3	CS-6	L					
Serie 6 Coupè (F12) 2p	07/11>	24	13	AG-3	CS-6	L					
Serie 6 Grand Coupè (F06) 4p	04/12>	36	15	AG-3	CS-7	L					
Serie 7	11/15>	36	15	AG-3	CS-7	L					
Serie 7 (E32)	01/86>04/94	36	15	AG-3	CS-7	L					
Serie 7 (E38)	05/94>10/01	36	15	AG-3	CS-7	L					
Serie 7 (E65) (E66)	11/01>09/08	36	15	AG-3	CS-7	L					
Serie 7 (F01)	10/08>10/15	36	15	AG-3	CS-7	L					
X1 (E84)	10/09>10/15	62	35	AG-7	CS-5	MPV-M					
X1 (F48)	11/15>	62	35	AG-7	CS-5	MPV-M					
X3 (E83)	01/04>10/10	62	35	AG-7	CS-5	MPV-M					
X3 (F25)	11/10>	68	35	AG-7	CS-6	MPV-M					
X4 (F26)	06/14>	50	31	AG-7	CS-6	MPV-M					
X5 (E53)	05/00>02/07	68	35	AG-7	CS-6	MPV-M					
X5 (E70)	03/07>09/13	50	31	AG-8	CS-6	MPV-M					
X5 (F15)	10/13>	50	31	AG-8	CS-6	MPV-M					
X6 (E71)	06/08>11/14	50	31	AG-8	CS-6	MPV-M					
X6 (F16)	12/14>	52	39	AG-8	CS-7	MPV-M					
Z4 Roadster (E85) (E86)	01/03>04/09	28	07	AG-4	CS-4	S					
Z4 Roadster (E89)	05/09>	28	07	AG-4	CS-4	S					
CHEVROLET											
Aveo 3p	02/05>04/11	12	03	AG-1	CS-3	M					
Aveo 4p	05/11>09/15	20	11	AG-2	CS-5	L					
Aveo 5p	09/02>04/11	12	03	AG-1	CS-3	M					
Aveo 5p	05/11>09/15	26	07	AG-4	CS-4	L					
Camaro	09/11>	24	13	AG-3	CS-6	M					
Captiva	07/06>09/15	68	35	AG-7	CS-6	MPV-M					
Corvette	11/04>09/13	20	11	AG-2	CS-5	M					
Corvette Stingray	10/13>	20	11	AG-2	CS-5	M					
Cruze 4p	03/09>09/15	20	11	AG-2	CS-5	L					
Cruze 5p	09/11>11/15	34	17	AG-5	CS-5	SW-L					
Cruze sw	09/12>09/15	32	19	AG-5	CS-6	SW-L					
Lacetti 5p	04/04>12/09	30	09	AG-4	CS-5	M					
Lacetti sw	01/05>12/09	32	19	AG-5	CS-6	SW-L					
Malibu	10/12>09/15	24	13	AG-3	CS-6	L					
Matiz	05/05>01/10	10	03	AG-1	CS-2	S					
Nubira sw	01/05>12/09	32	19	AG-5	CS-6	SW-M					
Orlando	01/11>09/15	48	23	AG-6	CS-5	MPV-M					
Spark	02/10>09/15	56	25	AG-1	CS-2	S					
Tacuma 5p	09/00>12/09	30	09	AG-4	CS-5	MPV-M					
Trax	03/13>09/15	48	23	AG-6	CS-5	SW-M					
Volt	03/12>09/15	34	17	AG-5	CS-5	L					
CHRYSLER											
300C 4p	05/05>12/10	36	15	AG-3	CS-7	L					
300C Touring	05/05>12/10					AG-8	CS-7	SW-L			
Crossfire Coupè 2p	11/03>12/07	26	07	AG-4	CS-4	M					
Grand Voyager	07/01>03/08	52	39	AG-8	CS-7	MPV-M					
Grand Voyager	04/08>10/11	52	39	AG-8	CS-7	MPV-M					
Pt Cruiser 5p	06/00>12/10	62	35	AG-7	CS-5	MPV-M					
Sebring	01/95>04/07	36	15	AG-3	CS-7	L					
Sebring	05/07>12/10	24	13	AG-3	CS-6	L					
Viper	05/93>06/01	24	13	AG-3	CS-6	L					
Vision	11/93>06/99	36	15	AG-3	CS-7	L					
Voyager	01/96>02/01	50	31	AG-7	CS-6	MPV-M					
Voyager	03/01>03/08	50	31	AG-7	CS-6	MPV-M					
CITROEN											
Berlingo Multispace 5p	05/96>03/08	48	23	AG-6	CS-5	MPV-M					
Berlingo Multispace 5p	04/08>	48	23	AG-6	CS-5	MPV-M					
C1 3p	05/05>05/14	10	03	AG-1	CS-2	S					
C1 3p	06/14>	10	03	AG-1	CS-2	S					
C1 5p	05/05>05/14	10	03	AG-1	CS-2	S					
C1 5p	06/14>	10	03	AG-1	CS-2	S					
C1 Aircscape 3p	06/14>	10	03	AG-1	CS-2	S					
C1 Aircscape 5p	06/14>	10	03	AG-1	CS-2	S					
C2	10/03>03/10	12	03	AG-1	CS-3	S					
C3	05/02>10/09	14	05	AG-1	CS-4	M					
C3	11/09>10/16	14	05	AG-1	CS-4	M					
C3	11/16>	26	07	AG-1	CS-4	M					
C3 Classic	11/09>12/10	14	05	AG-1	CS-4	M					
C3 Picasso	01/09>09/16	46	23	AG-6	CS-4	SW-M					
C3 Pluriel	05/03>11/10	26	07	AG-4	CS-4	M					
C3 XTR	03/04>12/08	26	07	AG-4	CS-4	M					
C4 3p	01/05>10/10	30	09	AG-4	CS-5	L					
C4 5p	01/05>10/10	30	09	AG-4	CS-5	L					
C4 5p	11/10>	30	09	AG-4	CS-5	SW-M					
C4 Aircross	04/12>	48	23	AG-6	CS-5	MPV-M					
C4 Cactus	05/14>	48	23	AG-6	CS-5	SW-M					
C4 Grand Picasso	10/06>09/13	68	35	AG-7	CS-6	MPV-M					
C4 Grand Picasso	10/13>	68	35	AG-7	CS-6	MPV-M					
C4 Picasso	03/07>05/13	62	35	AG-7	CS-5	MPV-M					
C4 Picasso	06/13>	62	35	AG-7	CS-5	MPV-M					
C5 4p	03/01>04/08	22	13	AG-3	CS-6	L					
C5 4p	05/08>	22	13	AG-3	CS-6	L					
C5 sw	03/01>04/08	40	19	AG-5	CS-6	SW-L					
C5 Tourer	05/08>	40	19	AG-5	CS-6	SW-L					
C6	11/05>11/12	24	13	AG-3	CS-6	L					
C8	11/02>12/13	50	31	AG-7	CS-6	MPV-M					
C-Crosser	06/07>01/13	68	35	AG-7	CS-6	MPV-M					
C-Elysée 4p	03/16>	20	11	AG-2	CS-5	L					
C-Zero	11/10>	10	03	AG-1	CS-2	S					
DS3	03/10>01/16	14	05	AG-1	CS-4	M					
DS3	02/16>	16	11	AG-1	CS-5	L					
DS3 Cabrio	11/12>	14	05	AG-1	CS-4	M					
DS4	03/11>	30	09	AG-4	CS-5	SW-M					
DS4 Crossback	11/15>	30	09	AG-4	CS-5	SW-M					
DS5	12/11>	34	17	AG-5	CS-5	L					
E-Mehari	09/16>	58	29	AG-1	CS-3	L					
Evasion	06/94>07/02	50	31	AG-7	CS-6	MPV-M					
Nemo 5p	12/08>03/14	46	23	AG-6	CS-4	SW-M					
Saxo	02/96>09/03	12	03	AG-1	CS-3	S					
Xsara 5p	09/97>12/04	18	11	AG-2	CS-5	M					
Xsara Break	03/98>12/05	32	19	AG-5	CS-6	SW-M					
Xsara Coupè 3p	03/98>12/04	18	11	AG-2	CS-5	M					
Xsara Picasso	02/00>09/10	62	35	AG-7	CS-5	MPV-M					

Modello Auto Car Model	Anno Year	VENUS PRESTIGE	SATURN POLYESTER	METEO-MAX 4 STAGIONI	STRETCH-FIT	UMBRELLA
DACIA						
Dokker	11/12>	48	23	AG-6	CS-5	SW-L
Dokker Stepway	11/12>	48	23	AG-6	CS-5	MPV-M
Duster	05/10>	48	23	AG-6	CS-5	SW-L
Lodgy	05/12>	62	35	AG-7	CS-5	SW-L
Logan 5p	01/06>06/11	18	11	AG-2	CS-5	SW-L
Logan MCV 5p	02/07>06/13	34	17	AG-5	CS-5	SW-L
Logan MCV 5p	10/13>	62	35	AG-4	CS-5	SW-L
Sandero	09/08>12/12	26	07	AG-4	CS-4	M
Sandero	01/13>	26	07	AG-4	CS-4	M
Sandero Stepway	07/09>12/12	26	07	AG-4	CS-4	M
Sandero Stepway	01/13>	26	07	AG-4	CS-4	M
DAEWOO						
Kalos 3p	02/05>05/08	14	05	AG-1	CS-4	S
Kalos 5p	09/02>05/08	14	05	AG-1	CS-4	S
Nubira 4p	06/97>01/05	20	11	AG-2	CS-5	M
Nubira 5p	06/97>12/99	18	11	AG-2	CS-5	M
DAIHATSU						
Charade	05/11>09/13	12	03	AG-1	CS-3	S
Copen	01/04>12/10	08	03	AG-1	CS-2	S
Cuore	01/03>08/07	08	03	AG-1	CS-2	S
Cuore	09/07>09/11	08	03	AG-1	CS-2	S
Materia	01/07>12/11	58	29	AG-6	CS-3	M
Sirion	01/05>09/11	10	03	AG-1	CS-2	S
Terios	01/97>04/06	44	23	AG-6	CS-4	M
Terios	04/06>09/13	46	23	AG-6	CS-4	M
Trevis	01/04>12/10	08	03	AG-1	CS-2	S
DODGE						
Avenger	02/08>12/11	24	13	AG-3	CS-6	SW-L
Caliber	06/06>12/11	62	35	AG-7	CS-5	SW-L
Journey	06/08>12/11	68	35	AG-8	CS-6	MPV-M
Nitro	07/07>12/11	50	31	AG-7	CS-6	MPV-M
DR						
City Cross	10/13>	12	03	AG-1	CS-3	SW-L
Dr1	01/10>06/14	10	03	AG-1	CS-2	S
Dr2	06/10>06/13	12	03	AG-1	CS-3	S
Dr5	04/08>	48	23	AG-6	CS-5	M
Zero	10/15>	10	03	AG-1	CS-2	M
FERRARI						
360	03/99>07/05	24	13	AG-3	CS-6	L
458	01/10>12/15	20	11	AG-2	CS-5	M
488 GTB	07/15>	20	11	AG-2	CS-5	M
488 Spider	02/16>	20	11	AG-2	CS-5	M
550	09/96>07/02	24	13	AG-3	CS-6	L
599	07/06>06/12	24	13	AG-3	CS-6	L
612	02/04>12/10	36	15	AG-3	CS-7	L
California	10/08>02/12	20	11	AG-2	CS-5	M
California	02/14>	20	11	AG-2	CS-5	M
F12	02/12>	22	11	AG-2	CS-6	L
F355	06/94>06/00	22	13	AG-3	CS-6	L
F430	10/04>07/10	24	13	AG-3	CS-6	L
FF	02/11>	24	13	AG-5	CS-6	L
GTC4 Lusso 2p	09/16>	40	19	AG-5	CS-6	SW-L
GTO	03/84>10/85	22	13	AG-3	CS-6	L
FIAT						
124 Spider	05/16>	16	11	AG-2	CS-4	M
126	01/72>09/00	06	03	AG-1	CS-1	S
500	07/57>08/75	04	03	AG-1	CS-1	S
500	07/07>	10	03	AG-1	CS-2	S
500C	07/09>	10	03	AG-1	CS-2	S

Modello Auto Car Model	Anno Year	VENUS PRESTIGE	SATURN POLYESTER	METEO-MAX	STRETCH-FIT	UMBRELLA
500L	09/12>	28	07	AG-4	CS-5	SW-M
500L Living	07/13>	30	09	AG-6	CS-5	SW-M
500L Trekking	11/13>	30	09	AG-4	CS-5	SW-M
500X	02/15>	30	09	AG-4	CS-5	SW-M
Barchetta	09/94>06/05	16	07	AG-1	CS-4	S
Brava	10/95>12/03	18	11	AG-2	CS-5	M
Bravo	10/95>10/01	26	07	AG-4	CS-4	M
Bravo	02/07>11/15	30	09	AG-4	CS-5	M
Cinquecento	01/91>12/98	04	03	AG-1	CS-1	S
Coupè	02/94>12/00	18	11	AG-2	CS-5	M
Croma	05/85>12/96	20	11	AG-2	CS-5	L
Croma	05/05>04/11	32	19	AG-5	CS-6	SW-L
Doblò 5p	11/00>12/09	48	23	AG-6	CS-5	MPV-M
Doblò 5p	01/10>	48	23	AG-6	CS-5	MPV-M
Freemont	05/11>	50	31	AG-8	CS-6	MPV-M
Grande Punto 3p	09/05>04/12	26	07	AG-4	CS-4	L
Grande Punto 5p	09/05>04/12	26	07	AG-4	CS-4	L
Idea	01/04>04/08	58	29	AG-6	CS-3	M
Idea	05/08>11/12	58	29	AG-6	CS-3	M
Linea	01/07>11/14	20	11	AG-2	CS-5	L
Marea 5p	09/96>12/03	20	11	AG-2	CS-5	L
Marea Weekend	09/96>12/03	34	17	AG-5	CS-5	SW-L
Multipla	11/98>05/04	48	23	AG-6	CS-5	SW-L
Multipla	06/04>12/10	48	23	AG-6	CS-5	SW-L
Palio	01/96>12/07	26	07	AG-4	CS-4	
Panda	02/80>08/03	10	03	AG-1	CS-2	S
Panda	09/03>01/12	56	25	AG-1	CS-2	S
Panda	02/12>	58	29	AG-1	CS-2	M
Panda 4x4	09/04>12/13	58	29	AG-1	CS-2	S
Panda 4x4	11/12>	58	29	AG-1	CS-2	M
Panda Classic	02/12>12/12	56	25	AG-1	CS-2	S
Panda Cross	10/14>	58	29	AG-1	CS-2	M
Punto 3p	01/93>08/99	12	03	AG-1	CS-3	M
Punto 3p	09/99>08/09	12	03	AG-1	CS-3	M
Punto 3p	01/12>	26	07	AG-4	CS-4	L
Punto 5p	01/93>08/99	12	03	AG-1	CS-3	M
Punto 5p	09/99>08/09	12	03	AG-1	CS-3	M
Punto 5p	01/12>	26	07	AG-4	CS-4	L
Punto Evo 3p	10/09>04/12	26	07	AG-4	CS-4	L
Punto Evo 5p	10/09>04/12	26	07	AG-4	CS-4	L
Punto Van 3p	01/12>	26	07	AG-4	CS-4	L
Qubo 5p	09/08>	46	23	AG-6	CS-4	SW-L
Sedici	03/06>05/15	46	23	AG-6	CS-4	MPV-M
Seicento	01/98>06/11	08	03	AG-1	CS-2	S
Stilo 3p	01/02>12/07	30	09	AG-4	CS-5	L
Stilo 5p	01/02>12/07	30	09	AG-4	CS-5	L
Stilo Multiwagon	01/02>05/08	34	17	AG-5	CS-5	SW-L
Tempra 5p	03/90>08/97	20	11	AG-2	CS-5	L
Tempra sw	03/90>08/97	32	19	AG-5	CS-6	SW-M
Tipo	07/87>04/95	26	07	AG-4	CS-4	M
Tipo 4p	12/15>	20	11	AG-2	CS-5	L
Tipo 5p	05/16>	30	09	AG-4	CS-5	L
Tipo sw	09/16>	32	19	AG-5	CS-6	SW-L
Ulysse	01/94>05/02	50	31	AG-7	CS-6	MPV-M
Ulysse	06/02>12/10	50	31	AG-7	CS-6	MPV-M
Uno	01/83>08/00	10	03	AG-1	CS-2	S
FORD						
B-Max	10/12>	46	23	AG-6	CS-4	SW-M
C-Max	10/03>10/10	62	35	AG-7	CS-5	MPV-M
C-Max	11/10>	62	35	AG-7	CS-5	MPV-M
C-Max 7	11/10>	68	35	AG-7	CS-6	MPV-M

Modello Auto Car Model	Anno Year	VENUS PRESTIGE	SATURN POLYESTER	METEO-MAX 4 STAGIONI	STRETCH-FIT	UMBRELLA	Modello Auto Car Model	Anno Year	VENUS PRESTIGE	SATURN POLYESTER	METEO-MAX	STRETCH-FIT	UMBRELLA
Ecosport	03/14>	48	27	AG-6	CS-5	SW-L	Civic Tourer	04/14>	32	19	AG-4	CS-5	SW-L
Edge	07/16>	50	31	AG-7	CS-6	MPV-M	Concerto 5p	01/90>12/95	18	11	AG-2	CS-5	M
Fiesta 3p	04/96>10/02	12	03	AG-1	CS-3	M	CR-V	01/96>03/02	68	35	AG-7	CS-6	MPV-M
Fiesta 3p	11/02>08/08	14	05	AG-1	CS-4	L	CR-V	04/02>12/06	68	35	AG-7	CS-6	MPV-M
Fiesta 3p	09/08>	14	05	AG-1	CS-4	L	CR-V	01/07>09/12	68	35	AG-7	CS-6	MPV-M
Fiesta 5p	04/96>04/02	12	03	AG-1	CS-3	M	CR-V	10/12>	68	35	AG-7	CS-6	MPV-M
Fiesta 5p	05/02>08/08	14	05	AG-1	CS-4	L	CR-Z	05/10>	46	23	AG-6	CS-4	M
Fiesta 5p	09/08>	14	05	AG-1	CS-4	L	FR-V 5p	11/04>12/10	48	23	AG-6	CS-5	MPV-M
Focus 3p	01/99>01/05	28	07	AG-4	CS-5	SW-M	HR-V	09/15>	48	23	AG-6	CS-5	MPV-M
Focus 3p	02/05>02/11	30	09	AG-4	CS-5	L	HR-V 3p	01/99>12/06	60	35	AG-7	CS-4	MPV-M
Focus 5p	10/98>01/05	20	11	AG-2	CS-5	SW-M	HR-V 5p	01/99>12/06	60	35	AG-7	CS-4	MPV-M
Focus 5p	02/05>02/11	30	09	AG-4	CS-5	L	Insight Hybrid	04/09>09/13	30	09	AG-4	CS-5	SW-L
Focus 5p	03/11>	30	09	AG-4	CS-5	L	Jazz	10/01>10/08	14	05	AG-1	CS-4	M
Focus Wagon	02/99>01/05	32	19	AG-5	CS-6	SW-L	Jazz	11/08>08/15	14	05	AG-1	CS-4	M
Focus Wagon	02/05>05/11	34	17	AG-5	CS-5	SW-L	Jazz	09/15>	26	07	AG-4	CS-4	L
Focus Wagon	06/11>	32	19	AG-5	CS-6	SW-L	NSX	08/16>	20	11	AG-4	CS-5	L
Fusion	08/02>11/12	26	07	AG-4	CS-4	L	HUMMER						
Galaxy	01/95>08/06	50	31	AG-7	CS-6	MPV-M	H2	01/03>12/07	52	39		CS-7	MPV-M
Galaxy	09/06>09/15	50	31	AG-7	CS-6	MPV-M	H3	08/05>02/10	50	31	AG-7	CS-6	MPV-M
Galaxy	10/15>	50	31	AG-7	CS-6	MPV-M	HYUNDAI						
Ka	09/96>12/08	10	03	AG-1	CS-2	S	Accent	09/95>03/06	16	07	AG-1	CS-4	S
Ka	01/09>09/16	10	03	AG-1	CS-2	S	Accent	04/06>12/09	28	07	AG-4	CS-5	M
Ka+	10/16>	14	05	AG-1	CS-4	S	Atos	09/97>03/08	56	25	AG-1	CS-2	S
Kuga	06/08>02/13	62	35	AG-7	CS-5	MPV-M	Coupè	01/96>12/01	20	11	AG-2	CS-5	M
Kuga	03/13>	62	35	AG-7	CS-5	MPV-M	Coupè	01/02>12/09	20	11	AG-2	CS-5	M
Mondeo 4p	10/96>10/00	24	13	AG-3	CS-6	L	Elantra	12/00>01/07	20	11	AG-2	CS-5	M
Mondeo 4p	11/00>04/07	22	13	AG-3	CS-6	L	Genesis	06/14>	36	15	AG-3	CS-7	L
Mondeo 4p	05/07>10/14	24	13	AG-3	CS-6	L	Genesis Coupè	01/11>05/14	22	13	AG-3	CS-6	M
Mondeo 4p	11/14>	24	13	AG-5	CS-6	L	Getz 3p	07/02>01/09	12	03	AG-1	CS-3	S
Mondeo 5p	10/96>11/02	22	13	AG-3	CS-6	L	Getz 5p	07/02>01/09	12	03	AG-1	CS-3	S
Mondeo 5p	12/02>04/07	22	13	AG-3	CS-6	L	Grand Santa Fe	03/14>	68	35	AG-8	CS-7	MPV-M
Mondeo 5p	05/07>10/14	24	13	AG-3	CS-6	L	H1 (van)	10/97>01/08	50	31	AG-7	CS-6	MPV-M
Mondeo 5p	11/14>	24	13	AG-3	CS-6	SW-L	i10	04/08>10/13	10	03	AG-1	CS-2	M
Mondeo Hybrid 4p	11/14>	40	19	AG-5	CS-6	SW-L	i10	11/13>	12	03	AG-1	CS-2	S
Mondeo sw	10/96>12/00	40	19	AG-5	CS-6	SW-L	i20 3p	02/09>05/12	14	05	AG-1	CS-4	M
Mondeo sw	01/01>04/07	40	19	AG-5	CS-6	SW-L	i20 3p	06/12>02/15	26	07	AG-4	CS-4	SW-M
Mondeo Wagon	05/07>10/14	40	19	AG-5	CS-6	SW-L	i20 3p	03/15>	26	07	AG-1	CS-4	M
Mondeo Wagon	11/14>	40	19	AG-5	CS-6	SW-L	i20 5p	02/09>05/12	14	05	AG-1	CS-4	M
Mustang	05/15>	24	13	AG-5	CS-6	L	i20 5p	06/12>10/14	26	07	AG-4	CS-4	SW-M
Puma	01/97>12/00	16	05	AG-1	CS-4	L	i20 5p	11/14>	26	07	AG-4	CS-4	SW-M
S-Max	06/06>09/15	68	35	AG-7	CS-6	MPV-M	i30 3p	01/13>	30	09	AG-4	CS-5	SW-M
S-Max	10/15>	50	31	AG-7	CS-6	MPV-M	i30 5p	09/07>02/12	30	09	AG-4	CS-5	M
Streetka	12/02>07/05	12	03	AG-1	CS-2	S	i30 5p	03/12>	30	09	AG-4	CS-5	SW-M
Tourneo Connect 7	11/14>	68	35	AG-7	CS-6	MPV-M	i30 CW	04/08>08/12	34	17	AG-5	CS-5	SW-L
Tourneo Courier	03/14>	60	27	AG-6	CS-4	MPV-M	i30 Wagon	09/12>	34	17	AG-5	CS-5	SW-L
HONDA							i40 4p	04/12>06/15	24	13	AG-3	CS-6	SW-L
Accord 4p	04/03>05/08	22	13	AG-3	CS-6	L	i40 Wagon	07/11>	40	19	AG-5	CS-6	SW-L
Accord 4p	06/08>09/14	22	13	AG-3	CS-6	L	loniq elettrica	12/16>	34	17	AG-4	CS-5	SW-L
Accord Tourer	04/03>06/08	40	19	AG-5	CS-6	SW-L	ix20	11/10>	60	27	AG-4	CS-4	SW-M
Accord Tourer	07/08>12/13	32	19	AG-5	CS-6	SW-L	ix35	03/10>12/15	62	35	AG-7	CS-5	MPV-M
City	01/06>12/12	10	03	AG-1	CS-2	S	ix55	04/09>09/12	50	31	AG-8	CS-6	MPV-M
Civic 3p	01/96>12/00	26	07	AG-4	CS-4	L	Matrix	11/01>10/10	60	27	AG-7	CS-4	SW-M
Civic 3p	01/01>12/05	28	07	AG-4	CS-5	M	Santa Fe	01/01>02/06	68	35	AG-7	CS-6	MPV-M
Civic 3p	01/06>01/12	28	07	AG-4	CS-5	M	Santa Fe	03/06>09/12	68	35	AG-7	CS-6	MPV-M
Civic 4p	01/96>12/00	32	19	AG-5	CS-6	L	Santa Fe	10/12>	68	35	AG-7	CS-6	MPV-M
Civic 4p	01/01>04/06	20	11	AG-2	CS-5	M	Santamo	01/99>12/01	50	31	AG-7	CS-6	MPV-M
Civic 4p	05/06>03/09	20	11	AG-2	CS-5	M	Terracan	01/02>12/08	68	35	AG-7	CS-6	MPV-M
Civic 5p	01/96>12/00	26	07	AG-4	CS-4	L	Tucson	08/04>02/10	48	23	AG-6	CS-5	MPV-M
Civic 5p	01/01>12/05	30	09	AG-4	CS-5	M	Tucson	09/15>	62	35	AG-4	CS-5	MPV-M
Civic 5p	01/06>01/12	28	07	AG-4	CS-5	M	Veloster	09/11>10/13	28	07	AG-4	CS-5	SW-M
Civic 5p	02/12>	28	07	AG-4	CS-5	M							

Modello Auto Car Model	Anno Year	VENUS PRESTIGE	SATURN POLYESTER	METEO-MAX 4 STAGIONI	STRETCH-FIT	UMBRELLA
INFINITI						
Q30	12/15>	62	35	AG-6	CS-5	MPV-M
Q50	01/14>	32	19	AG-5	CS-6	SW-M
Q60 4p	11/16>	22	13	AG-5	CS-6	L
QX30	08/16>	62	35	AG-6	CS-5	MPV-M
QX50	01/14>	68	35	AG-7	CS-6	MPV-M
QX70	01/14>	50	31	AG-8	CS-6	MPV-M
INNOCENTI						
Mille	01/93>10/97	10	03	AG-1	CS-2	S
ISUZU						
Trooper	01/91>09/04	68	35	AG-7	CS-6	MPV-M
JAGUAR						
F-Pace	04/16>	50	31	AG-7	CS-6	MPV-M
F-Type Cabrio	04/13>06/16	20	11	AG-2	CS-5	L
F-Type Cabrio	07/16>	30	09	AG-4	CS-5	M
F-Type Coupè	05/14>	20	11	AG-2	CS-5	L
S-Type	04/99>02/08	36	15	AG-3	CS-7	L
XE	06/15>	22	13	AG-2	CS-6	L
XF 4p	03/08>10/15	36	15	AG-3	CS-7	L
XF 4p	11/15>	36	15	AG-3	CS-7	L
XF Sportbrake	11/12>	40	19	AG-5	CS-6	SW-L
XJ	03/03>02/10	36	15	AG-3	CS-7	L
XJ	03/10>	36	15	AG-3	CS-7	L
XJR	03/03>09/07	36	15	AG-3	CS-7	L
XK	03/96>02/06	22	13	AG-3	CS-6	L
XK	03/06>06/15	22	13	AG-3	CS-6	L
XKR	03/04>09/14	24	13	AG-3	CS-6	SW-L
X-Type 4p	04/01>12/09	24	13	AG-3	CS-6	SW-L
X-Type sw	04/04>12/09	32	19	AG-5	CS-6	SW-L
JEEP						
Cherokee	01/84>09/01	62	35	AG-7	CS-5	MPV-M
Cherokee	10/01>04/08	62	35	AG-7	CS-5	MPV-M
Cherokee	05/08>04/14	62	35	AG-7	CS-5	MPV-M
Cherokee	05/14>	50	31	AG-7	CS-5	MPV-M
Commander	04/06>12/10	50	31	AG-7	CS-6	MPV-M
Compass	11/06>07/15	62	35	AG-7	CS-5	MPV-M
Grand Cherokee	04/92>03/99	50	31	AG-7	CS-6	MPV-M
Grand Cherokee	04/99>05/05	50	31	AG-7	CS-6	MPV-M
Grand Cherokee	06/05>12/10	50	31	AG-7	CS-6	MPV-M
Grand Cherokee	01/11>	50	31	AG-7	CS-6	MPV-M
Patriot	10/07>12/12	62	35	AG-7	CS-4	MPV-M
Renegade	09/14>	48	23	AG-6	CS-5	MPV-M
Wrangler	01/87>02/07	46	23	AG-6	CS-4	M
Wrangler 2p	03/07>	48	23	AG-6	CS-5	MPV-M
Wrangler 4p	03/07>	68	35	AG-7	CS-6	MPV-M
KIA						
Carens	07/02>11/06	62	35	AG-7	CS-5	SW-L
Carens	12/06>04/13	62	35	AG-7	CS-5	SW-L
Carens	05/13>	62	35	AG-7	CS-5	SW-L
Carnival	04/99>05/06	52	39	AG-8	CS-7	MPV-M
Carnival	06/06>12/11	52	39	AG-8	CS-7	MPV-M
Cee'd 5p	02/07>04/12	28	07	AG-4	CS-5	M
Cee'd 5p	05/12>	30	09	AG-4	CS-5	M
Cee'd Sportswagon	09/12>	34	17	AG-5	CS-5	SW-L
Cee'd Sporty Wagon	09/07>08/12	34	17	AG-5	CS-5	SW-L
Niro	09/16>	30	09	AG-6	CS-5	SW-L
Optima 4p	02/16>	24	13	AG-3	CS-6	L
Optima ibrida plug-in 4p	10/16>	24	13	AG-3	CS-6	L
Optima Sportswagon	10/16>	40	19	AG-5	CS-6	SW-L
Picanto	04/04>04/11	10	03	AG-1	CS-2	S
Picanto 3p	05/11>	10	03	AG-1	CS-2	S

Modello Auto Car Model	Anno Year	VENUS PRESTIGE	SATURN POLYESTER	METEO-MAX	STRETCH-FIT	UMBRELLA
Picanto 5p	05/11>	10	03	AG-1	CS-2	S
Pro Cee'd 3p	01/08>08/11	28	07	AG-4	CS-5	M
Pro Cee'd 3p	06/13>	30	09	AG-4	CS-5	M
Rio 3p	09/11>12/14	28	07	AG-4	CS-5	M
Rio 5p	07/00>09/05	28	07	AG-4	CS-5	M
Rio 5p	10/05>08/11	28	07	AG-4	CS-5	M
Rio 5p	09/11>	28	07	AG-4	CS-5	M
Sorento	07/02>10/09	68	35	AG-7	CS-6	MPV-M
Sorento	11/09>01/15	68	35	AG-7	CS-6	MPV-M
Sorento	02/15>	68	35	AG-7	CS-6	MPV-M
Soul	03/09>12/13	46	23	AG-6	CS-4	MPV-M
Soul	01/14>	48	23	AG-6	CS-4	MPV-M
Sportage	07/93>10/04	48	23	AG-6	CS-5	MPV-M
Sportage	11/04>08/10	48	23	AG-6	CS-5	MPV-M
Sportage	09/10>02/16	48	23	AG-7	CS-5	MPV-M
Sportage	03/16>	68	35	AG-5	CS-5	MPV-M
Venga	02/10>	46	23	AG-6	CS-4	SW-M
LAMBORGHINI						
Gallardo	09/03>09/13	18	11	AG-2	CS-5	M
Huracàn	05/14>	20	11	AG-2	CS-5	M
Huracàn Spyder	04/16>	20	11	AG-2	CS-5	M
Murcielago	01/02>12/10	20	11	AG-2	CS-5	M
Murcielago Roadster	01/05>12/10	20	11	AG-2	CS-5	M
LANCIA						
Dedra	01/89>07/99	20	11	AG-2	CS-5	L
Delta	01/81>07/93	26	07	AG-4	CS-4	L
Delta	08/93>12/00	26	07	AG-4	CS-4	L
Delta	06/08>06/15	20	11	AG-2	CS-5	SW-L
Flavia	04/12>12/14	24	13	AG-3	CS-6	L
K 4p	01/95>12/01	24	13	AG-3	CS-6	L
K sw	06/96>12/01	40	19	AG-5	CS-6	SW-L
Lybra 4p	09/99>12/06	20	11	AG-2	CS-5	SW-M
Lybra sw	09/99>12/06	32	19	AG-5	CS-6	SW-L
Musa	09/04>09/07	46	23	AG-6	CS-4	SW-M
Musa	10/07>12/13	46	23	AG-6	CS-4	SW-M
Phedra	09/02>11/10	50	31	AG-7	CS-6	MPV-M
Thema 4p	11/84>12/94	22	13	AG-3	CS-6	L
Thema 4p	11/11>04/15	36	15	AG-3	CS-7	L
Thema sw	11/84>12/94	40	19	AG-5	CS-6	SW-L
Thesis	01/02>12/09	24	13	AG-3	CS-6	L
Voyager	11/11>					MPV-M
Y	11/95>08/03	12	03	AG-1	CS-3	S
Y10	01/85>10/95	12	03	AG-1	CS-3	S
Ypsilon 3p	09/03>05/11	12	03	AG-1	CS-3	M
Ypsilon 5p	06/11>	12	03	AG-1	CS-3	M
Ypsilon Unyca 3p	06/11>12/13	12	03	AG-1	CS-3	M
Zeta	09/94>02/02	50	31	AG-7	CS-6	MPV-M
LAND ROVER						
Defender 3p	01/90>07/10	46	23	AG-6	CS-4	SW-M
Defender 5p	01/90>07/10	50	31	AG-7	CS-6	MPV-M
Discovery 3p	01/89>10/98	50	31	AG-7	CS-6	MPV-M
Discovery 5p	01/89>10/98	50	31	AG-7	CS-6	MPV-M
Discovery 5p	11/98>09/04	50	31	AG-7	CS-6	MPV-M
Discovery 5p	10/04>08/09	50	31	AG-8	CS-6	MPV-M
Discovery 5p	09/09>	50	31	AG-8	CS-6	MPV-M
Discovery Sport 5p	02/15>	68	35	AG-7	CS-6	MPV-M
Evoque 3p	04/11>	62	35	AG-7	CS-5	MPV-M
Evoque 5p	04/11>	62	35	AG-7	CS-5	MPV-M
Evoque Cabrio	04/16>	62	35	AG-7	CS-5	MPV-M
Freelander	10/97>11/06	48	23	AG-6	CS-5	MPV-M
Freelander	12/06>08/15	50	31	AG-7	CS-6	MPV-M

Modello Auto Car Model	Anno Year	VENUS PRESTIGE	SATURN POLYESTER	METEO-MAX 4 STAGIONI	STRETCH-FIT	UMBRELLA
Range Rover	01/87>05/94	52	39	AG-8	CS-7	MPV-M
Range Rover	06/94>01/02	52	39	AG-8	CS-7	MPV-M
Range Rover	02/02>10/12	52	39	AG-8	CS-7	MPV-M
Range Rover	11/12>	52	39	AG-8	CS-7	MPV-M
Range Rover Sport	05/05>05/13	50	31	AG-7	CS-6	MPV-M
Range Rover Sport	06/13>	50	31	AG-7	CS-6	MPV-M
LEXUS						
CT	03/11>	30	09	AG-4	CS-5	M
GS	05/05>04/12	24	13	AG-3	CS-6	L
GS	05/12>	24	13	AG-3	CS-6	L
IS 4p	01/06>04/13	20	11	AG-2	CS-5	L
IS 4p	05/13>	22	13	AG-3	CS-6	L
IS C 2p	07/09>12/12	22	13	AG-3	CS-6	L
LS	01/89>12/06	36	15	AG-3	CS-7	L
LS	01/07>	36	15	AG-3	CS-7	SW-L
NX	10/14>	68	35	AG-7	CS-6	MPV-M
RC	02/16>	22	11	AG-3	CS-6	M
RC Coupè	09/14>	22	13	AG-3	CS-6	SW-L
RX	05/03>05/09	50	31	AG-7	CS-6	MPV-M
RX	06/09>12/15	68	35	AG-7	CS-6	MPV-M
RX	01/16>	50	31	AG-8	CS-6	MPV-M
SC	09/01>12/09	22	13	AG-3	CS-6	L
MASERATI						
Coupè	01/02>02/08	22	13	AG-3	CS-6	L
Ghibli 4p	06/13>	36	15	AG-3	CS-7	L
GrandSport	07/04>01/08	22	13	AG-3	CS-6	L
Levante	05/16>	52	39	AG-8	CS-7	MPV-M
Quattroporte	01/04>06/12	24	13	AG-3	CS-6	L
Quattroporte	01/13>	24	13	AG-3	CS-6	L
Spyder	09/01>03/06	20	11	AG-2	CS-5	L
MAZDA						
2 3p	01/03>09/07	28	07	AG-4	CS-5	M
2 3p	10/07>02/15	12	03	AG-1	CS-3	L
2 5p	01/03>09/07	28	07	AG-4	CS-5	M
2 5p	10/07>02/15	12	03	AG-1	CS-3	L
2 5p	03/15>	26	07	AG-4	CS-4	M
3 4p	01/04>10/10	30	09	AG-1	CS-5	M
3 4p	11/10>09/13	30	09	AG-4	CS-5	L
3 5p	01/04>03/09	30	09	AG-4	CS-5	L
3 5p	04/09>12/13	34	17	AG-5	CS-5	L
3 5p	01/14>	34	17	AG-5	CS-5	L
323	10/96>09/03	30	09	AG-4	CS-5	L
5 5p	08/05>10/10	34	17	AG-5	CS-5	MPV-M
5 5p	11/10>10/13	32	19	AG-5	CS-6	SW-M
6 4p	10/03>03/08	22	13	AG-3	CS-6	L
6 4p	04/08>12/12	22	13	AG-3	CS-6	L
6 4p	01/13>	24	13	AG-3	CS-6	L
6 Wagon	09/02>03/08	32	19	AG-5	CS-6	SW-L
6 Wagon	04/08>12/12	32	19	AG-5	CS-6	SW-L
6 Wagon	01/13>	32	19	AG-5	CS-6	SW-L
626 sw	06/98>09/03	32	19	AG-5	CS-6	SW-L
CX-3	06/15>	60	27	AG-2	CS-5	L
CX-5	04/12>	68	35	AG-7	CS-6	MPV-M
CX-7	06/07>12/13	68	35	AG-7	CS-6	MPV-M
Demio	11/98>03/03	14	05	AG-1	CS-4	M
MPV	06/00>04/06	50	31	AG-7	CS-6	MPV-M
MX-5	01/98>12/05	16	11	AG-2	CS-4	M
MX-5	01/06>09/15	16	11	AG-2	CS-4	M
MX-5	10/15>	16	11	AG-2	CS-4	M
Premacy	03/99>07/05	62	35	AG-7	CS-5	MPV-M
RX-8	04/03>06/11	20	11	AG-2	CS-5	L

Modello Auto Car Model	Anno Year	VENUS PRESTIGE	SATURN POLYESTER	METEO-MAX	STRETCH-FIT	UMBRELLA
Tribute	09/01>04/06	48	23	AG-6	CS-5	MPV-M
MERCEDES						
190 - W201	01/87>12/93	20	11	AG-2	CS-5	L
200 - T,TD,TE (W124)	01/85>12/93	22	13	AG-5	CS-6	L
200 - W124	01/88>12/93	22	13	AG-5	CS-6	L
230 - TE (W124)	01/85>12/93	22	13	AG-5	CS-6	L
230 - W124	01/88>12/93	22	13	AG-5	CS-6	L
250 - TD (W124)	01/85>12/93	22	13	AG-5	CS-6	L
250 - W124	01/88>12/93	22	13	AG-5	CS-6	L
260 - W124	01/88>12/93	22	13	AG-5	CS-6	L
300 - Cabrio CE (W124)	01/92>12/93	22	13	AG-2	CS-6	L
300 - SL (W129)	01/89>12/93	22	13	AG-2	CS-6	L
300 - TE,TD (W124)	01/85>12/93	22	13	AG-5	CS-6	L
300 - W124	01/88>12/93	22	13	AG-5	CS-6	L
320 - Coupè (W124)	01/92>12/93	22	13	AG-5	CS-6	L
320 - S. Wagon (W124)	01/92>12/96	32	19	AG-5	CS-6	SW-L
320 - W124	01/92>12/96	22	13	AG-5	CS-6	L
400 - E (W124)	01/90>12/93	22	13	AG-5	CS-6	L
500 - E (W124)	01/90>12/93	22	13	AG-5	CS-6	L
500 - W129	01/89>12/93	22	13	AG-2	CS-5	L
AMG - C36 (W202)	01/94>12/96	20	11	AG-2	CS-5	L
AMG - E36 (W124)	01/94>12/95	22	13	AG-5	CS-6	L
AMG - E36 (W210)	01/96>12/00	24	13	AG-3	CS-6	L
CL	01/96>02/00	36	15	AG-3	CS-7	L
CL	03/00>08/06	36	15	AG-3	CS-7	L
CL	09/06>12/13	36	15	AG-3	CS-7	L
CLA 4p	02/13>	22	13	AG-3	CS-6	L
CLA Shooting Brake	03/15>	32	19	AG-5	CS-6	SW-L
Classe A 3p	09/04>12/10	26	07	AG-4	CS-4	L
Classe A 5p	05/97>08/04	12	03	AG-1	CS-3	L
Classe A 5p	09/04>09/12	26	07	AG-4	CS-4	L
Classe A 5p	10/12>	30	09	AG-4	CS-5	L
Classe A lunga/long 5p	06/01>08/04	12	03	AG-1	CS-3	L
Classe B	05/05>09/11	60	27	AG-7	CS-4	MPV-M
Classe B	10/11>	48	23	AG-6	CS-5	MPV-M
Classe C 4p	05/93>04/00	22	13	AG-3	CS-6	L
Classe C 4p	05/00>01/07	22	13	AG-3	CS-6	L
Classe C 4p	02/07>02/14	22	13	AG-3	CS-6	L
Classe C 4p	03/14>	22	13	AG-3	CS-6	L
Classe C Cabrio	06/16>	22	13	AG-3	CS-6	M
Classe C Coupè 2p	03/01>03/08	18	11	AG-2	CS-5	M
Classe C Coupè 2p	04/11>11/15	20	11	AG-2	CS-5	L
Classe C Coupè 2p	12/15>	22	13	AG-3	CS-6	L
Classe C sw	05/96>03/01	32	19	AG-5	CS-6	SW-L
Classe C sw	04/01>12/07	34	17	AG-5	CS-5	SW-L
Classe C sw	01/08>08/14	32	19	AG-5	CS-6	SW-L
Classe C sw	09/14>	32	19	AG-5	CS-6	SW-L
Classe E 4p	12/84>05/95	24	13	AG-3	CS-6	L
Classe E 4p	06/95>02/02	24	13	AG-3	CS-6	L
Classe E 4p	03/02>02/09	24	13	AG-3	CS-6	L
Classe E 4p	03/09>06/16	24	13	AG-3	CS-6	L
Classe E 4p	07/16>	36	15	AG-3	CS-7	L
Classe E Cabrio	01/10>	22	13	AG-3	CS-6	L
Classe E Coupè 2p	03/09>	22	13	AG-3	CS-6	L
Classe E sw	05/96>02/03	40	19	AG-5	CS-6	SW-L
Classe E sw	03/03>08/09	40	19	AG-5	CS-6	SW-L
Classe E sw	09/09>11/16	40	19	AG-5	CS-6	SW-L
Classe G	01/90>	50	31	AG-7	CS-6	MPV-M
Classe R	02/06>12/13	52	39	AG-8	CS-7	MPV-M
Classe S	10/98>08/05	36	15	AG-3	CS-7	L
Classe S	09/05>08/13	36	15	AG-3	CS-7	L

Modello Auto Car Model	Anno Year	VENUS PRESTIGE	SATURN POLYESTER	METEO-MAX 4 STAGIONI	STRETCH-FIT	UMBRELLA
Classe S	09/13>	36	15	AG-3	CS-7	L
Classe S Cabrio	03/16>	38	15	AG-3	CS-7	L
Classe S Coupè	05/14>	36	15	AG-8	CS-7	L
CLC	04/08>06/11	20	11	AG-2	CS-5	L
CLK	01/96>05/02	20	11	AG-2	CS-5	L
CLK	06/02>12/09	22	13	AG-3	CS-6	L
CLS	10/04>11/10	36	15	AG-3	CS-7	L
CLS	12/10>	36	15	AG-3	CS-7	L
CLS Shooting Brake	09/12>	36	15	AG-3	CS-7	SW-L
GL	09/06>06/12	52	39	AG-8	CS-7	MPV-M
GL	07/12>02/16	52	39	AG-8	CS-7	MPV-M
GLA	03/14>	62	35	AG-6	CS-6	MPV-M
GLC	09/15>	50	31	AG-7	CS-6	MPV-M
GLC Coupè	10/16>	50	31	AG-7	CS-6	MPV-M
GLE 5p	07/15>	50	31	AG-8	CS-6	MPV-M
GLE Coupè 5p	07/15>	52	39	AG-8	CS-7	MPV-M
GLK	10/08>02/12	62	35	AG-7	CS-5	SW-L
GLK	03/12>09/15	68	35	AG-7	CS-6	SW-L
GLS	03/16>	52	39	AG-8	CS-7	MPV-M
ML	01/98>06/05	50	31	AG-7	CS-6	MPV-M
ML	07/05>09/11	50	31	AG-7	CS-6	MPV-M
ML	10/11>12/15	50	31	AG-8	CS-6	MPV-M
SL	01/93>09/01	20	11	AG-2	CS-5	L
SL	10/01>01/12	22	13	AG-3	CS-6	L
SL	02/12>	22	13	AG-3	CS-6	L
SLC	03/16>	16	11	AG-6	CS-4	L
SLK	09/96>03/04	26	07	AG-1	CS-4	M
SLK	04/04>03/11	16	11	AG-2	CS-4	S
SLK	04/11>12/15	16	11	AG-2	CS-4	M
SLS 2p	02/10>	22	13	AG-5	CS-6	S
SLS Roadster	10/11>	22	13	AG-5	CS-6	S
MINI						
Clubman	11/07>06/15	14	05	AG-1	CS-4	SW-M
Clubman (F54) 5p	11/14>	28	07	AG-6	CS-5	SW-M
Countryman	09/10>	26	07	AG-4	CS-4	SW-M
Mini 3p	09/01>10/06	12	03	AG-1	CS-3	M
Mini 3p	11/06>02/14	12	03	AG-1	CS-3	M
Mini 3p	03/14>	12	03	AG-1	CS-3	M
Mini 5p	07/14>	26	07	AG-4	CS-4	M
Mini Cabrio	03/09>02/16	12	03	AG-1	CS-3	M
Mini Cabrio	03/16>	12	05	AG-1	CS-3	M
Mini Coupè 2p	07/11>	12	03	AG-1	CS-3	M
Paceman	03/13>	28	07	AG-4	CS-5	SW-M
Roadster	01/12>	12	03	AG-1	CS-3	M
MITSUBISHI						
ASX	07/10>	62	35	AG-7	CS-5	MPV-M
Colt	11/95>05/04	12	03	AG-1	CS-3	M
Colt 3p	03/05>12/08	12	03	AG-1	CS-3	M
Colt 3p	01/09>05/12	12	03	AG-1	CS-3	M
Colt 5p	06/04>12/08	12	03	AG-1	CS-3	M
Colt 5p	01/09>05/12	12	03	AG-1	CS-3	M
Grandis	10/05>06/11	68	35	AG-5	CS-6	MPV-M
I-Miev	01/11>	10	03	AG-1	CS-2	S
L200 Club Cab 2p	01/05>08/15					M
L200 Double Cab 4p	01/05>08/15					M
L300 5p	01/81>12/02	50	31	AG-7	CS-6	MPV-M
Lancer 4p	09/03>06/08	26	07	AG-4	CS-4	L
Lancer 4p	07/08>12/11	30	09	AG-4	CS-5	L
Lancer Sportback 5p	07/08>12/11	30	09	AG-4	CS-5	L
Lancer sw	09/03>06/08	34	17	AG-5	CS-5	SW-L
Outlander	05/03>01/07	68	35	AG-7	CS-6	MPV-M

Modello Auto Car Model	Anno Year	VENUS PRESTIGE	SATURN POLYESTER	METEO-MAX	STRETCH-FIT	UMBRELLA
Outlander	02/07>09/12	68	35	AG-7	CS-6	MPV-M
Outlander	10/12>	68	35	AG-7	CS-6	MPV-M
Pajero 3p	01/91>03/00	48	23	AG-6	CS-5	MPV-M
Pajero 3p	04/00>10/06	48	23	AG-6	CS-5	MPV-M
Pajero 3p	11/06>	48	23	AG-6	CS-5	MPV-M
Pajero 5p	01/91>03/00	48	23	AG-6	CS-5	MPV-M
Pajero 5p	04/00>10/06	50	31	AG-7	CS-6	MPV-M
Pajero 5p	11/06>	50	31	AG-8	CS-6	MPV-M
Pajero Pinin 5p	07/99>12/06	46	23	AG-6	CS-4	L
Pajero Sport	07/08>12/12	68	35	AG-7	CS-6	MPV-M
Space Runner	10/91>12/01	48	23	AG-6	CS-5	MPV-M
Space Star 5p	04/13>	12	03	AG-1	CS-3	S
Space Wagon	07/98>01/04	50	31	AG-7	CS-6	MPV-M
NISSAN						
350Z	07/03>06/09	20	11	AG-2	CS-5	L
370Z	07/09>11/14	28	07	AG-4	CS-5	L
Almera 5p	04/00>12/06	26	07	AG-4	CS-4	M
Cube	03/10>12/11	46	23	AG-6	CS-4	L
Evalia	10/11>	48	23	AG-6	CS-5	MPV-M
GT-R	05/09>	22	13	AG-2	CS-6	L
Juke	10/10>	60	27	AG-7	CS-4	MPV-M
Leaf	04/12>12/15	62	35	AG-7	CS-5	M
Leaf	01/16>	62	35	AG-7	CS-5	M
Micra	01/92>08/00	12	03	AG-1	CS-3	S
Micra	09/00>12/02	12	03	AG-1	CS-3	S
Micra	11/10>	12	03	AG-1	CS-3	M
Micra 3p	01/03>10/10	12	03	AG-1	CS-3	S
Micra 5p	01/03>10/10	12	03	AG-1	CS-3	S
Micra C+C	09/05>10/10	12	03	AG-1	CS-3	S
Murano	10/08>05/15	68	35	AG-7	CS-6	MPV-M
Navara 4p	01/05>07/14					M
Navara 4p	08/14>					M
Note	03/06>09/13	26	07	AG-4	CS-4	M
Note	10/13>	26	07	AG-4	CS-4	M
Pathfinder	01/97>02/05	50	31	AG-7	CS-6	MPV-M
Pathfinder	03/05>09/10	50	31	AG-7	CS-6	MPV-M
Pathfinder	10/10>06/14	50	31	AG-7	CS-6	MPV-M
Patrol GR	01/97>12/09	50	31	AG-7	CS-6	MPV-M
Pixo	06/09>07/13	10	03	AG-1	CS-2	S
Primera 4p	01/02>12/08	22	13	AG-3	CS-6	L
Primera sw	01/02>12/08	40	19	AG-5	CS-6	SW-L
Pulsar	10/14>	30	09	AG-4	CS-5	M
Qashqai	03/07>01/14	48	23	AG-6	CS-5	MPV-M
Qashqai	01/14>	48	23	AG-6	CS-5	MPV-M
Qashqai+2	09/08>01/14	62	35	AG-7	CS-5	MPV-M
Terrano	05/93>02/05	50	31	AG-7	CS-6	MPV-M
X-Trail	09/01>05/14	68	35	AG-7	CS-6	MPV-M
X-Trail	06/14>	68	35	AG-7	CS-6	MPV-M
OPEL						
Adam	02/13>	12	03	AG-1	CS-3	S
Adam Rocks	09/14>	12	03	AG-1	CS-3	S
Adam Rocks Swing Top	09/14>	12	03	AG-1	CS-3	S
Adam Swing Top	01/15>	12	03	AG-1	CS-3	S
Agila	05/00>01/08	56	25	AG-1	CS-2	S
Agila	02/08>10/15	58	29	AG-6	CS-3	M
Ampera	03/12>05/15	34	17	AG-4	CS-5	L
Antara	11/06>	68	35	AG-7	CS-6	MPV-M
Astra F 5p	09/91>08/02	26	07	AG-4	CS-4	M
Astra G 3p	11/00>03/05	18	11	AG-2	CS-5	M
Astra G 5p	04/98>02/04	18	11	AG-2	CS-5	M
Astra G sw	10/98>02/04	34	17	AG-5	CS-5	SW-M

Modello Auto Car Model	Anno Year	VENUS PRESTIGE	SATURN POLYESTER	METEO-MAX 4 STAGIONI	STRETCH-FIT	UMBRELLA	Modello Auto Car Model	Anno Year	VENUS PRESTIGE	SATURN POLYESTER	METEO-MAX	STRETCH-FIT	UMBRELLA
Astra H 5p	03/04>12/09	28	07	AG-4	CS-5	M	207 sw	07/07>12/13	34	17	AG-5	CS-5	SW-M
Astra H GTC 3p	04/05>08/11	30	09	AG-4	CS-5	M	208 3p	04/12>	26	07	AG-4	CS-4	L
Astra H Sports Tourer	03/04>10/10	34	17	AG-5	CS-5	SW-M	208 5p	04/12>	26	07	AG-4	CS-4	L
Astra J 4p	09/12>	22	13	AG-3	CS-6	L	3008	05/09>09/16	62	35	AG-7	CS-5	MPV-M
Astra J 5p	01/10>10/15	30	09	AG-4	CS-5	M	3008	10/16>	62	35	AG-7	CS-5	MPV-M
Astra J GTC 3p	09/11>	30	09	AG-4	CS-5	SW-L	306 5p	03/93>05/01	26	07	AG-4	CS-4	M
Astra J Sports Tourer	11/10>02/16	32	19	AG-5	CS-6	SW-L	306 sw	03/93>05/01	32	19	AG-5	CS-6	SW-M
Astra K 5p	11/15>	20	11	AG-4	CS-5	L	307 3p	06/01>08/07	28	07	AG-4	CS-5	L
Astra K Sports Tourer	03/16>	32	19	AG-5	CS-6	SW-L	307 5p	06/01>08/07	28	07	AG-4	CS-5	L
Cascada Cabrio	04/13>	22	13	AG-3	CS-6	L	307 cc	01/04>03/09	18	11	AG-2	CS-5	M
Combo Tour 5p	04/12>	48	23	AG-6	CS-5	MPV-M	307 sw	05/02>04/08	34	17	AG-5	CS-5	SW-M
Corsa 3p	10/93>09/00	12	03	AG-1	CS-3	S	308 5p	09/07>09/13	30	09	AG-4	CS-5	L
Corsa 3p	10/00>08/06	12	03	AG-1	CS-3	S	308 5p	10/13>	30	09	AG-4	CS-5	L
Corsa 3p	09/06>11/14	26	07	AG-4	CS-4	S	308 cc	04/09>05/14	20	11	AG-2	CS-5	M
Corsa 3p	12/14>	26	07	AG-1	CS-4	S	308 sw	05/08>04/14	34	17	AG-5	CS-5	MPV-M
Corsa 5p	10/93>09/00	12	03	AG-1	CS-3	S	308 sw	05/14>	32	19	AG-5	CS-5	MPV-M
Corsa 5p	10/00>08/06	12	03	AG-1	CS-3	S	4007	07/08>12/12	68	35	AG-7	CS-6	MPV-M
Corsa 5p	09/06>11/14	26	07	AG-4	CS-4	S	4008	04/12>	48	23	AG-6	CS-5	MPV-M
Corsa 5p	12/14>	26	07	AG-4	CS-4	S	406	04/99>02/05	22	13	AG-3	CS-6	L
Frontera	09/98>09/04	68	35	AG-5	CS-6	MPV-M	406 sw	04/99>02/05	40	19	AG-5	CS-6	SW-L
Insignia 4p	02/09>	24	13	AG-3	CS-6	L	407 4p	05/04>05/11	22	13	AG-3	CS-6	L
Insignia Sport Tourer	03/09>	40	19	AG-5	CS-6	SW-L	407 sw	09/04>12/11	32	19	AG-5	CS-6	SW-L
Karl	12/14>	12	03	AG-1	CS-2	S	5008	11/09>01/16	62	35	AG-7	CS-5	MPV-M
Meriva	04/03>04/10	46	23	AG-6	CS-4	MPV-M	508 4p	03/11>	24	13	AG-3	CS-6	L
Meriva	05/10>	48	23	AG-6	CS-5	MPV-M	508 Rxh	05/12>	40	19	AG-5	CS-6	SW-L
Mokka	11/12>03/16	48	23	AG-6	CS-5	SW-M	508 sw	03/11>	40	19	AG-5	CS-6	SW-L
Mokka X	04/16>	48	23	AG-6	CS-5	SW-M	607	04/00>12/10	24	13	AG-3	CS-6	MPV-M
Omega sw	06/94>12/03	40	19	AG-5	CS-6	SW-L	806	01/98>09/02	50	31	AG-7	CS-6	MPV-M
Signum	06/03>12/08	32	19	AG-5	CS-6	SW-L	807	10/02>12/13	50	31	AG-7	CS-6	MPV-M
Tigra TwinTop	09/04>12/09	16	11	AG-2	CS-4	S	Bipper Tepee 5p	03/09>	46	23	AG-6	CS-4	SW-M
Vectra 4p	01/96>09/02	20	11	AG-2	CS-5	L	lon	03/11>	56	25	AG-1	CS-2	S
Vectra 4p	05/02>01/09	22	13	AG-3	CS-6	L	Partner Tepee 5p	05/96>12/02	48	23	AG-6	CS-5	SW-M
Vectra 5p	01/96>09/02	20	11	AG-2	CS-5	L	Partner Tepee 5p	05/08>	48	23	AG-6	CS-5	SW-M
Vectra 5p	10/02>01/09	22	13	AG-3	CS-6	L	Ranch 5p	05/96>03/08	48	23	AG-6	CS-5	MPV-M
Vectra sw	01/04>02/09	40	19	AG-5	CS-6	SW-M	Rcz	06/10>	18	11	AG-4	CS-5	L
Zafira	04/99>08/05	62	35	AG-7	CS-5	MPV-M	PORSCHE						
Zafira	09/05>10/11	62	35	AG-7	CS-5	MPV-M	718	07/16>	18	11	AG-2	CS-5	M
Zafira One	11/11>07/15	62	35	AG-7	CS-5	MPV-M	911	09/97>06/04	20	11	AG-2	CS-5	M
Zafira Tourer	11/11>	68	35	AG-7	CS-6	MPV-M	911	07/04>09/11	20	11	AG-2	CS-5	M
PEUGEOT							911 Carrera	10/11>	20	11	AG-2	CS-5	M
1007	05/05>05/10	44	29	AG-6	CS-3	M	911 Carrera Cabriolet	03/12>	20	11	AG-2	CS-5	M
106	09/91>06/04	10	03	AG-1	CS-2	S	911 Targa	05/14>	20	11	AG-2	CS-5	M
107 3p	07/05>12/14	10	03	AG-1	CS-2	S	996	03/97>06/05	20	11	AG-2	CS-5	M
107 5p	07/05>12/14	10	03	AG-1	CS-2	S	Boxster	03/96>03/12	20	11	AG-2	CS-5	M
108 3p	06/14>	10	03	AG-1	CS-2	S	Boxster	04/12>	20	11	AG-2	CS-5	M
108 5p	06/14>	10	03	AG-1	CS-2	S	Boxster Spyder	07/15>	20	11	AG-2	CS-5	M
108 Top! 3p	06/14>	10	03	AG-1	CS-2	S	Carrera	09/93>12/97	20	11	AG-2	CS-5	M
108 Top! 5p	06/14>	10	03	AG-1	CS-2	S	Carrera GT	11/03>04/06	22	13	AG-3	CS-6	L
2008	06/13>	60	27	AG-6	CS-4	SW-M	Cayenne	01/03>01/10	50	31	AG-7	CS-6	MPV-M
205	01/83>12/97	10	03	AG-1	CS-2	S	Cayenne	02/10>	50	31	AG-7	CS-6	MPV-M
206 3p	09/98>02/09	12	03	AG-1	CS-3	M	Cayman	11/05>10/12	20	11	AG-2	CS-5	M
206 5p	09/98>02/09	12	03	AG-1	CS-3	M	Cayman	11/12>	20	11	AG-2	CS-5	M
206 cc	02/01>03/07	16	11	AG-2	CS-4	S	Macan	12/13>	68	35	AG-7	CS-6	MPV-M
206 Plus 3p	03/09>01/13	12	03	AG-1	CS-3	M	Panamera	09/09>10/16	36	15	AG-3	CS-7	L
206 Plus 5p	03/09>01/13	12	03	AG-1	CS-3	M	Panamera	11/16>	36	15	AG-3	CS-7	L
206 sw	09/02>06/07	34	17	AG-5	CS-5	SW-M	RENAULT						
207 3p	05/06>11/12	26	07	AG-4	CS-4	M	Be Bop	05/09>12/10	44	23	AG-6	CS-4	L
207 5p	05/06>11/12	26	07	AG-4	CS-4	M	Captur	05/13>	28	07	AG-4	CS-5	SW-M
207 cc	03/07>05/14	16	11	AG-2	CS-4	M	Clio II 3p	03/98>09/05	12	03	AG-1	CS-3	S
207 Plus 3p	02/13>	26	07	AG-4	CS-4	M	Clio II 5p	03/98>09/05	12	03	AG-1	CS-3	S
207 Plus 5p	02/13>	26	07	AG-4	CS-4	M	Clio II Storia 3p	10/05>12/10	12	03	AG-1	CS-3	M

Modello Auto Car Model	Anno Year	VENUS PRESTIGE	SATURN POLYESTER	METEO-MAX 4 STAGIONI	STRETCH-FIT	UMBRELLA
Clio II Storia 5p	10/05>12/10	12	03	AG-1	CS-3	M
Clio III 3p	10/05>01/13	26	07	AG-4	CS-4	M
Clio III 5p	10/05>01/13	26	07	AG-4	CS-4	M
Clio III Sportour	02/08>08/13	28	07	AG-4	CS-5	SW-M
Clio IV 5p	10/12>	26	07	AG-4	CS-4	M
Clio IV Sporter	04/13>	30	09	AG-4	CS-5	SW-L
Espace	01/96>10/02	50	31	AG-7	CS-6	MPV-M
Espace	11/02>08/12	50	31	AG-8	CS-6	MPV-M
Espace	09/12>04/15	50	31	AG-7	CS-6	MPV-M
Espace	05/15>	50	31	AG-7	CS-6	MPV-M
Fluence	01/12>04/15	22	13	AG-3	CS-6	L
Grand Kangoo 5p	10/12>	68	35	AG-7	CS-6	MPV-M
Grand Modus	02/08>03/13	46	23	AG-6	CS-4	SW-M
Grand Scenic 7 posti	04/04>04/09	68	35	AG-7	CS-6	MPV-M
Kadjar	06/15>	68	35	AG-7	CS-6	MPV-M
Kangoo 5p	01/97>01/08	46	23	AG-6	CS-4	L
Kangoo 5p	02/08>	48	23	AG-6	CS-5	L
Koleos	06/08>01/14	62	35	AG-7	CS-5	MPV-M
Laguna II 5p	03/01>09/07	22	13	AG-3	CS-6	L
Laguna II Grandtour	03/01>09/07	32	19	AG-5	CS-6	SW-L
Laguna III 5p	10/07>04/13	22	13	AG-3	CS-6	L
Laguna III Coupè 2p	12/08>	22	13	AG-3	CS-6	L
Laguna III Sportour	10/07>	40	19	AG-5	CS-6	SW-L
Megane I 3p	01/96>08/03	16	07	AG-2	CS-4	M
Megane I 5p	01/96>08/03	28	07	AG-4	CS-5	M
Megane I Cabrio	05/97>06/03	16	07	AG-2	CS-4	M
Megane I sw	01/99>09/02	32	19	AG-5	CS-6	SW-L
Megane II 3p	10/02>10/08	30	09	AG-4	CS-5	M
Megane II 4p	10/03>10/08	20	11	AG-2	CS-5	L
Megane II 5p	10/02>10/08	30	09	AG-4	CS-5	M
Megane II C-C	01/03>05/10	18	11	AG-2	CS-5	M
Megane II Grandtour	09/03>08/09	34	17	AG-5	CS-5	SW-M
Megane III 5p	11/08>12/15	28	07	AG-4	CS-5	M
Megane III C-C	06/10>	20	11	AG-2	CS-5	M
Megane III Coupè 3p	03/09>	28	07	AG-4	CS-5	M
Megane III Sportour	09/09>09/16	34	17	AG-5	CS-5	SW-L
Megane IV 5p	01/16>	30	09	AG-4	CS-5	L
Megane IV Sporter	10/16>	32	19	AG-5	CS-6	L
Modus	09/04>06/13	58	29	AG-6	CS-3	M
Scenic	01/96>03/00	48	23	AG-6	CS-5	MPV-M
Scenic	03/00>05/03	48	23	AG-6	CS-5	MPV-M
Scenic	06/03>08/09	48	23	AG-6	CS-5	MPV-M
Scenic 5 posti	10/16>	68	35	AG-7	CS-5	MPV-M
Scenic 7 posti	05/09>10/16	68	35	AG-7	CS-6	MPV-M
Scenic RX4	01/99>12/02	62	35	AG-7	CS-5	MPV-M
Scenic X-Mod 5 posti	09/09>09/16	48	23	AG-6	CS-5	MPV-M
Talisman 4p	02/16>	24	13	AG-3	CS-6	L
Talisman Sporter	06/16>	40	19	AG-5	CS-6	SW-L
Thalia	01/98>10/08	18	11	AG-2	CS-5	M
Thalia	11/08>	18	11	AG-2	CS-5	M
Twingo	03/93>05/07					M
Twingo	06/07>08/14	10	03	AG-1	CS-2	M
Twingo	09/14>	10	03	AG-1	CS-2	M
Twingo Open Air	09/14>	10	03	AG-1	CS-2	M
Vel Satis	04/02>12/09	40	19	AG-5	CS-6	SW-L
Wind	07/10>12/12	12	03	AG-1	CS-3	S
Zoe	04/13>	26	07	AG-4	CS-4	M

ROVER / MG

200	01/99>05/05	26	07	AG-4	CS-4	M
25	02/00>05/05	26	07	AG-1	CS-3	M
45	02/00>05/05	20	11	AG-2	CS-5	M

Modello Auto Car Model	Anno Year	VENUS PRESTIGE	SATURN POLYESTER	METEO-MAX	STRETCH-FIT	UMBRELLA
75	01/99>05/05	24	13	AG-3	CS-6	M
75 Tourer sw	01/01>05/05	32	19	AG-5	CS-6	SW-L
TF	01/02>05/05	14	05	AG-1	CS-4	L
ZR	01/01>05/05	26	07	AG-1	CS-4	M
ZS	01/01>05/05	20	11	AG-2	CS-5	L
ZT	01/01>05/05	22	13	AG-5	CS-6	L

SAAB						
9-3 4p	01/98>06/02	22	13	AG-3	CS-6	L
9-3 Cabrio	01/98>06/12	22	13	AG-3	CS-6	L
9-3 Coupè 2p	01/98>06/02	22	13	AG-3	CS-6	L
9-3 Sport Sedan	07/05>06/12	32	19	AG-5	CS-6	SW-M
9-3 Sporthatch 4p	07/02>06/12	22	13	AG-3	CS-6	L
9-3x	10/09>06/12	32	19	AG-5	CS-6	SW-M
9-5 4p	01/01>08/10	24	13	AG-3	CS-6	L
9-5 4p	09/10>06/12	24	13	AG-3	CS-6	L
9-5 sw	01/01>08/10	40	19	AG-5	CS-6	SW-L

SEAT						
Alhambra	07/00>09/10	50	31	AG-7	CS-6	MPV-M
Alhambra	10/10>	50	31	AG-7	CS-6	MPV-M
Altea	04/04>12/14	30	09	AG-4	CS-5	M
Altea XL	01/07>06/15	62	35	AG-7	CS-5	SW-M
Arosa	02/97>06/04	12	03	AG-1	CS-3	M
Ateca	07/16>	62	35	AG-6	CS-5	SW-L
Cordoba	01/03>08/09	18	11	AG-2	CS-5	L
Exeo 4p	05/09>12/12	22	13	AG-3	CS-6	L
Exeo ST	09/09>12/12	32	19	AG-5	CS-6	SW-M
Ibiza 3p	01/02>08/09	26	07	AG-4	CS-4	M
Ibiza 5p	01/02>08/09	26	07	AG-4	CS-4	M
Ibiza 5p	06/08>	26	07	AG-4	CS-4	M
Ibiza SC 3p	10/08>	26	07	AG-4	CS-4	M
Ibiza ST	06/10>	34	17	AG-5	CS-5	SW-M
Leon	03/00>08/05	28	07	AG-4	CS-5	M
Leon	09/05>12/12	30	09	AG-4	CS-5	M
Leon 5p	01/13>	30	09	AG-4	CS-5	M
Leon SC 3p	06/13>	30	09	AG-4	CS-5	M
Leon ST	01/14>	32	19	AG-5	CS-5	SW-L
Leon X-Perience	03/15>	32	19	AG-5	CS-5	SW-L
Mii 3p	05/12>	10	03	AG-1	CS-2	S
Mii 5p	05/12>	10	03	AG-1	CS-2	S
Toledo	03/99>12/04	20	11	AG-2	CS-5	M
Toledo	01/05>09/09	34	17	AG-5	CS-5	M
Toledo	01/13>07/15	20	11	AG-2	CS-5	L

SKODA						
Citigo 3p	05/12>	10	03	AG-1	CS-2	S
Citigo 5p	05/12>	10	03	AG-1	CS-2	S
Fabia 4p	09/01>04/07	18	11	AG-2	CS-5	L
Fabia 5p	02/00>04/07	26	07	AG-4	CS-4	M
Fabia 5p	05/07>01/15	26	07	AG-4	CS-4	M
Fabia 5p	02/15>	26	07	AG-4	CS-4	M
Fabia Wagon	01/01>12/07	28	07	AG-4	CS-5	SW-M
Fabia Wagon	01/08>03/15	28	07	AG-4	CS-5	SW-M
Fabia Wagon	04/15>	28	07	AG-4	CS-5	SW-M
Octavia 5p	04/97>08/04	20	11	AG-2	CS-5	L
Octavia 5p	09/04>02/13	20	11	AG-2	CS-5	L
Octavia 5p	03/13>	22	13	AG-3	CS-6	L
Octavia Wagon	01/98>12/04	32	19	AG-5	CS-6	SW-L
Octavia Wagon	01/05>04/13	34	17	AG-5	CS-5	SW-L
Octavia Wagon	05/13>	32	19	AG-5	CS-6	SW-L
Rapid 5p	01/13>12/14	20	11	AG-2	CS-5	L
Rapid Spaceback	11/13>	30	09	AG-4	CS-5	SW-L
Roomster	09/06>	60	27	AG-7	CS-4	MPV-M

Modello Auto Car Model	Anno Year	VENUS PRESTIGE	SATURN POLYESTER	METEO-MAX 4 STAGIONI	STRETCH-FIT	UMBRELLA	Modello Auto Car Model	Anno Year	VENUS PRESTIGE	SATURN POLYESTER	METEO-MAX	STRETCH-FIT	UMBRELLA
Superb 4p	05/02>08/08	24	13	AG-3	CS-6	L	Ignis 5p	10/03>12/08	58	29	AG-6	CS-3	SW-L
Superb 4p	09/08>06/15	24	13	AG-3	CS-6	L	Jimny 3p	01/98>	58	29	AG-6	CS-3	SW-L
Superb 4p	07/15>	24	13	AG-3	CS-6	L	Jimny Cabrio	01/00>	58	29	AG-6	CS-3	SW-L
Superb Wagon	02/10>09/15	40	19	AG-5	CS-6	SW-L	Kizashi 4p	03/13>	22	13	AG-3	CS-6	L
Superb Wagon	10/15>	40	19	AG-5	CS-6	SW-L	Liana 5p	09/01>12/07	46	23	AG-6	CS-4	MPV-M
Yeti	10/09>	60	27	AG-7	CS-4	MPV-M	S-Cross	09/13>	48	27	AG-6	CS-4	MPV-M
SMART													
Forfour	04/04>12/06	14	05	AG-1	CS-4	M	Splash	03/08>09/15	12	03	AG-1	CS-3	SW-M
Forfour	11/14>	12	03	AG-1	CS-2	M	Swift	01/96>11/04	12	03	AG-1	CS-3	M
Fortwo	03/00>12/06	02	01			S	Swift 3p	05/05>08/10	12	03	AG-1	CS-3	M
Fortwo	01/07>10/14	02	01			S	Swift 3p	09/10>	12	03	AG-1	CS-3	M
Fortwo	11/14>	02	01		CS-1	S	Swift 5p	01/06>08/10	12	03	AG-1	CS-3	M
Fortwo Cabrio	03/00>12/06	02	01		CS-1	S	Swift 5p	09/10>	12	03	AG-1	CS-3	M
Fortwo Cabrio	01/07>11/15	02	01		CS-1	S	SX4	03/06>08/13	46	23	AG-6	CS-4	MPV-M
Fortwo Cabrio	03/16>	02	01		CS-1	S	Vitara 3p	01/89>12/98	44	23	AG-6	CS-4	L
Fortwo elettrica	12/16>	02	01		CS-1	S	Vitara 5p	01/89>12/98	48	23	AG-6	CS-5	MPV-M
Roadster	04/03>11/05	04	03	AG-1	CS-1	S	Vitara 5p	04/15>	48	23	AG-6	CS-6	MPV-M
SSANGYONG													
Actyon	11/06>12/11	68	35	AG-7	CS-6	MPV-M	Wagon R+	01/98>09/03	58	29	AG-6	CS-3	MPV-M
Korando	01/11>	48	23	AG-6	CS-5	MPV-M	Wagon R+	10/03>02/08	58	29	AG-6	CS-3	MPV-M
Kyron	11/06>12/11	68	35	AG-7	CS-6	MPV-M	TATA						
Musso	01/93>12/05	50	31	AG-7	CS-6	MPV-M	Aria	01/12>12/14	68	35	AG-7	CS-6	MPV-M
Rexton	11/02>12/12	68	35	AG-7	CS-6	MPV-M	Vista	07/10>12/14	12	03	AG-1	CS-3	M
Rexton W	02/13>	50	31	AG-7	CS-6	MPV-M	TESLA						
Rodius	11/13>	52	39	AG-8	CS-7	MPV-M	Model S	01/13>	36	15	AG-3	CS-7	L
Tivoli	05/15>	28	09	AG-4	CS-5	SW-L	Model X	06/16>	38	15	AG-3	CS-7	SW-L
XLV	06/16>	34	17	AG-4	CS-5	SW-L	TOYOTA						
SUBARU													
Brz	07/12>	18	11	AG-2	CS-5	M	Auris 3p	04/07>11/12	28	07	AG-4	CS-5	M
Forester	01/97>03/08	62	35	AG-7	CS-5	MPV-M	Auris 5p	04/07>11/12	28	07	AG-4	CS-5	M
Forester	04/08>01/13	62	35	AG-7	CS-5	MPV-M	Auris 5p	12/12>	30	09	AG-4	CS-5	M
Forester	02/13>	68	35	AG-7	CS-6	MPV-M	Auris Touring Sports	10/13>	32	19	AG-5	CS-5	SW-L
Impreza 5p	06/01>09/07	20	11	AG-2	CS-5	L	Avensis	10/97>04/03	22	13	AG-3	CS-6	L
Impreza 5p	10/07>10/16	30	09	AG-4	CS-5	L	Avensis 4p	05/03>03/09	22	13	AG-3	CS-6	L
Impreza Station Wagon	12/00>09/07	34	17	AG-5	CS-5	SW-M	Avensis 4p	04/09>12/15	22	13	AG-3	CS-6	L
Justy	01/94>10/07	12	03	AG-1	CS-3	M	Avensis Verso	05/01>12/08	68	35	AG-7	CS-6	MPV-M
Justy	11/07>12/08	10	03	AG-1	CS-2	S	Avensis Wagon	05/03>03/09	32	19	AG-5	CS-6	SW-L
Legacy 4p	01/96>04/03	22	13	AG-3	CS-6	L	Avensis Wagon	04/09>12/15	32	19	AG-5	CS-6	SW-L
Legacy 4p	05/03>03/10	22	13	AG-3	CS-6	L	Aygo 3p	09/05>05/14	10	03	AG-1	CS-2	S
Legacy 4p	04/10>09/13	22	13	AG-3	CS-6	L	Aygo 3p	06/14>	10	03	AG-1	CS-2	S
Legacy Station Wagon	01/99>04/03	40	19	AG-5	CS-6	SW-L	Aygo 5p	09/05>05/14	10	03	AG-1	CS-2	S
Legacy Station Wagon	05/03>08/09	40	19	AG-5	CS-6	SW-L	Aygo 5p	06/14>	10	03	AG-1	CS-2	S
Legacy Station Wagon	09/09>09/13	32	19	AG-5	CS-6	SW-L	Aygo X-Wave 3p	06/14>	10	03	AG-1	CS-2	S
Levorg sw	10/15>	32	19	AG-5	CS-6	SW-L	Aygo X-Wave 5p	06/14>	10	03	AG-1	CS-2	S
Outback	09/09>02/15	68	35	AG-7	CS-6	MPV-M	C-HR	12/16>	34	17	AG-4	CS-5	L
Outback	03/15>	68	35	AG-7	CS-6	MPV-M	Corolla 5p	01/02>12/07	30	09	AG-4	CS-5	M
Trezia	03/11>12/13	46	23	AG-6	CS-4	SW-M	Corolla sw	01/02>12/07	32	19	AG-5	CS-6	SW-L
Tribeca	11/06>07/10	68	35	AG-8	CS-6	MPV-M	Corolla Verso	01/02>08/04	48	23	AG-6	CS-5	MPV-M
WRX 4p	09/14>	20	11	AG-4	CS-5	L	Corolla Verso	09/04>05/09	48	23	AG-6	CS-5	MPV-M
Xv	01/12>	62	35	AG-7	CS-5	MPV-M	GT86	07/12>	18	11	AG-2	CS-5	M
SUZUKI													
Alto	01/94>12/03	08	03	AG-1	CS-2	S	Iq	01/09>	06	03	AG-1	CS-1	S
Alto	01/04>02/09	08	03	AG-1	CS-2	S	Land Cruiser 3p	12/02>10/09	48	23	AG-6	CS-5	MPV-M
Alto	03/09>03/15	10	03	AG-1	CS-2	S	Land Cruiser 3p	11/09>	48	23	AG-6	CS-5	MPV-M
Baleno	04/16>	26	07	AG-1	CS-4	M	Land Cruiser 5p	12/02>10/09	50	31	AG-8	CS-6	MPV-M
Celerio	11/14>	10	03	AG-1	CS-2	S	Land Cruiser 5p	11/09>	50	31	AG-7	CS-6	MPV-M
Grand Vitara 3p	01/99>09/05	60	27	AG-7	CS-4	MPV-M	Land Cruiser V8	03/08>10/15	52	39	AG-8	CS-7	MPV-M
Grand Vitara 3p	10/05>03/15	46	23	AG-6	CS-4	MPV-M	Prius 5p	01/00>02/04	62	35	AG-7	CS-5	SW-M
Grand Vitara 5p	01/99>09/05	48	23	AG-6	CS-5	MPV-M	Prius 5p	03/04>06/09	62	35	AG-7	CS-5	SW-M
Grand Vitara 5p	10/05>03/15	62	35	AG-7	CS-5	MPV-M	Prius 5p	07/09>02/16	62	35	AG-7	CS-5	SW-M
Ignis	01/17>	58	29	AG-1	CS-2	M	Prius 5p	03/16>	20	11	AG-2	CS-5	SW-M
							Prius+	07/12>	68	35	AG-7	CS-6	SW-L
							Rav4	02/06>03/10	48	23	AG-6	CS-5	MPV-M
							Rav4	04/10>02/13	62	35	AG-7	CS-5	MPV-M
							Rav4	03/13>	68	35	AG-7	CS-6	MPV-M

Modello Auto Car Model	Anno Year						VENUS PRESTIGE	SATURN POLYESTER	METEO-MAX 4 STAGIONI	STRETCH-FIT	UMBRELLA
Rav4 3p	01/94>09/00	44	23	AG-6	CS-4	SW-M					
Rav4 3p	10/00>01/06	44	29	AG-6	CS-3	SW-L					
Rav4 5p	01/94>09/00	60	35	AG-7	CS-4	MPV-M					
Rav4 5p	10/00>01/06	48	23	AG-6	CS-5	MPV-M					
Urban Cruiser	05/09>09/14	26	07	AG-4	CS-4	SW-M					
Verso	06/09>02/13	30	09	AG-4	CS-5	SW-M					
Verso	03/13>	62	35	AG-7	CS-5	SW-M					
Verso-S	03/11>06/15	46	23	AG-6	CS-4	SW-M					
Yaris 3p	04/99>12/05	12	03	AG-1	CS-3	S					
Yaris 3p	01/06>09/11	12	03	AG-1	CS-3	S					
Yaris 3p	10/11>	12	03	AG-1	CS-3	L					
Yaris 5p	04/99>12/05	12	03	AG-1	CS-3	S					
Yaris 5p	01/06>09/11	12	03	AG-1	CS-3	S					
Yaris 5p	10/11>	12	03	AG-1	CS-3	L					
Yaris Verso	08/99>09/05	46	23	AG-6	CS-4	SW-M					
VOLKSWAGEN											
Amarok 4p	04/11>					SW-L					
Bora 4p	10/97>02/06	20	11	AG-2	CS-5	M					
Eos	06/06>12/12	20	11	AG-2	CS-5	L					
Fox 3p	05/05>12/10	12	03	AG-1	CS-3	S					
Golf III	08/92>09/97	26	07	AG-4	CS-4	L					
Golf IV 3p	10/97>10/03	28	07	AG-4	CS-5	M					
Golf IV 5p	10/97>10/03	28	07	AG-4	CS-5	M					
Golf IV Variant	04/99>05/06	32	19	AG-5	CS-6	SW-M					
Golf Plus	05/05>07/14	28	07	AG-4	CS-5	SW-M					
Golf V 3p	11/03>10/08	28	07	AG-4	CS-5	L					
Golf V 5p	11/03>10/08	28	07	AG-4	CS-5	L					
Golf V Variant	05/07>09/09	34	17	AG-5	CS-5	M					
Golf VI 3p	11/08>10/12	28	07	AG-4	CS-5	L					
Golf VI 5p	11/08>10/12	28	07	AG-4	CS-5	L					
Golf VI Cabrio	09/11>10/14	28	07	AG-4	CS-5	M					
Golf VI Variant	10/09>09/13	34	17	AG-5	CS-5	L					
Golf VII 3p	11/12>	30	09	AG-4	CS-5	L					
Golf VII 5p	11/12>	30	09	AG-4	CS-5	L					
Golf VII Sportsvan	05/14>	48	23	AG-6	CS-5	SW-M					
Golf VII Variant	10/13>	40	19	AG-5	CS-6	SW-M					
Jetta	09/05>01/11	20	11	AG-2	CS-5	L					
Jetta	02/11>01/13	22	13	AG-3	CS-6	L					
Lupo	06/98>07/05	12	03	AG-1	CS-3	S					
Maggiolino	11/11>	28	07	AG-4	CS-5	SW-M					
Maggiolino Cabriolet	03/13>	28	07	AG-4	CS-5	SW-M					
New Beetle	04/99>06/05	26	07	AG-4	CS-4	L					
New Beetle	07/05>10/11	26	07	AG-4	CS-4	L					
Passat 4p	10/96>02/05	24	13	AG-3	CS-6	L					
Passat 4p	03/05>12/10	24	13	AG-3	CS-6	L					
Passat 4p	01/11>10/14	22	13	AG-3	CS-6	L					
Passat 4p	12/14>	22	13	AG-3	CS-6	L					
Passat Alltrack	03/12>09/15	32	19	AG-5	CS-6	SW-L					
Passat Alltrack	10/15>	32	19	AG-5	CS-6	SW-L					
Passat cc 4p	06/08>02/12	24	13	AG-3	CS-6	L					
Modello Auto Car Model	Anno Year						VENUS PRESTIGE	SATURN POLYESTER	METEO-MAX	STRETCH-FIT	UMBRELLA
Passat cc 4p	03/12>11/15	24	13	AG-3	CS-6	L					
Passat Variant	03/97>08/05	40	19	AG-5	CS-6	SW-L					
Passat Variant	09/05>12/10	32	19	AG-5	CS-6	SW-L					
Passat Variant	01/11>10/14	32	19	AG-5	CS-6	SW-L					
Passat Variant	11/14>	32	19	AG-5	CS-6	SW-L					
Phaeton	10/02>04/16	36	15	AG-3	CS-7	L					
Polo 3p	08/94>10/01	12	03	AG-1	CS-3	S					
Polo 3p	11/01>08/09	14	05	AG-1	CS-4	S					
Polo 3p	09/09>	14	05	AG-1	CS-4	S					
Polo 5p	08/94>10/01	12	03	AG-1	CS-3	S					
Polo 5p	11/01>08/09	14	05	AG-1	CS-4	S					
Polo 5p	09/09>	14	05	AG-1	CS-4	S					
Scirocco	10/08>	30	07	AG-4	CS-5	M					
Sharan	05/95>09/10	50	31	AG-7	CS-6	MPV-M					
Sharan	10/10>	50	31	AG-7	CS-6	MPV-M					
Tiguan	12/07>04/16	62	35	AG-7	CS-5	MPV-M					
Tiguan	05/16>	68	35	AG-7	CS-5	MPV-M					
Touareg	01/03>04/10	50	31	AG-7	CS-6	MPV-M					
Touareg	05/10>	50	31	AG-7	CS-6	MPV-M					
Touran	05/03>08/15	62	35	AG-7	CS-5	MPV-M					
Touran	09/15>	62	35	AG-7	CS-5	MPV-M					
Up! 3p	01/12>	10	03	AG-1	CS-2	M					
Up! 5p	01/12>	10	03	AG-1	CS-2	M					
Up! Cross 5p	10/13>	10	03	AG-1	CS-2	M					
VOLVO											
C30	10/06>03/13	28	07	AG-4	CS-5	M					
C70	01/96>12/05	20	11	AG-2	CS-5	L					
C70	01/06>04/13	20	11	AG-2	CS-5	L					
S40	08/95>12/03	20	11	AG-2	CS-5	L					
S40	01/04>12/12	20	11	AG-2	CS-5	L					
S60	10/00>08/10	22	13	AG-3	CS-6	L					
S60	09/10>	22	13	AG-3	CS-6	L					
S60 Cross Country	08/15>	22	13	AG-3	CS-6	L					
S80	01/98>04/06	24	13	AG-3	CS-6	L					
S80	05/06>	24	13	AG-3	CS-6	L					
S90 4p	09/16>	36	15	AG-3	CS-7	SW-L					
V40	09/12>	30	09	AG-4	CS-5	SW-M					
V40 Cross Country	01/13>	30	09	AG-4	CS-5	SW-M					
V40 sw	01/95>12/04	30	09	AG-4	CS-5	SW-M					
V50 sw	02/04>04/13	34	17	AG-5	CS-5	SW-L					
V60	11/10>	40	19	AG-5	CS-6	SW-L					
V60 Cross Country	05/15>	40	19	AG-5	CS-6	SW-L					
V70 sw	01/00>04/07	40	19	AG-5	CS-6	SW-L					
V70 sw	05/07>	40	19	AG-5	CS-6	SW-L					
V90 sw	09/16>	40	19	AG-5	CS-7	MPV-M					
XC60	11/08>	68	35	AG-7	CS-6	SW-L					
XC70 sw	01/00>04/07	40	19	AG-5	CS-6	SW-L					
XC70 sw	05/07>	40	19	AG-5	CS-6	SW-L					
XC90	09/02>06/15	50	31	AG-7	CS-6	MPV-M					
XC90	07/15>	52	39	AG-8	CS-7	MPV-M					

Aero-Tech

PANNELLI LATERALI IN POLIPROPILENE TRASPIRANTE
BREATHABLE POLYPROPYLENE SIDES

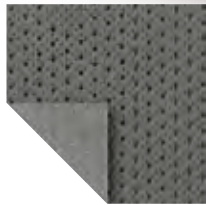

AERO-TECH, COPRI CAMPER

Appositamente progettato per proteggere il camper dal sole e dai raggi UV.

Ottima protezione contro la polvere, l'inquinamento e lo sporco. Tessuto resistente alle muffe e all'umidità...

- Angoli rinforzati in Pvc.
- Sistema di fissaggio sotto-scocca per tenere in tensione ed evitare lo svolazzamento della copertura.
- Completo di cinghie rinforzate e fibbie di fissaggio.
- Con zip multiple laterali per facilitare l'accesso al camper senza doverlo scoprire completamente.
- Lo speciale tessuto traspirante a 3 strati del tetto evita la formazione di umidità e condensa, ha un'alta resistenza all'acqua, ma è contemporaneamente traspirante per lasciare respirare il camper.
- La bordatura elasticizzata degli angoli anteriori e posteriori permette di avvolgere e mantenere la copertura aderente al camper.
- Nastri a strappo regolabili e perni di aggancio mantengono la copertura sempre in posizione.

AERO-TECH, MOTORHOME COVER

Specifically designed to protect motorhomes from sun and UV-Rays.

Excellent protection against dust, pollution and dirt. High resistance against mould and humidity...

- PVC reinforced corners
- Underbody fixing to keep in tension the cover and avoid the fluttering of it.
- Provided with reinforced belts and fixing buckle.
- With multiple side zippers to facilitate the access to the motorhome without removing the cover.
- 3 layer top protection which avoids the formation of humidity and condensation. Waterproof and at the same time transpiring.
- The stretching borders on the front and the rear ensure an adherent covering of the camper.
- The adjustable straps and coupling pivots maintain the cover always in position

Scatola / Box 1

PANNELLO SUPERIORE A TRIPLA COPERTURA

3 LAYERS TOP PROTECTION

- Primo strato esterno durevole
Soft durable polypropylene
- Aeror, pellicola microporosa traspirante
Aeror microphore breathable film
- Strato di tessuto soffice ed antigraffio
Soft durable polypropylene sides

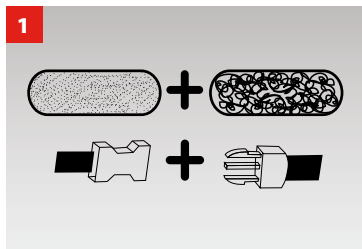
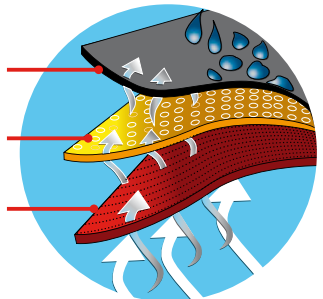

SISTEMA DI FISSAGGIO
ATTACHED REINFORCED STRAPS AND BUCKLES



ZIP MULTIPLE LATERALI
PER FACILITARE L'ACCESSO
WITH MULTIPLE SIDE ZIPPER ENTRY PANELS



ANGOLI RINFORZATI IN PVC
VINYL REINFORCED CORNERS



ANELLI DI FISSAGGIO LATERALI
PER TENDERE LA COPERTURA
CINCHING SYSTEM TO REMOVE SLACK

TIPO CAMPER MOTORHOME TYPE	MIS. SIZE	ART.	LUNGHEZZA cm LENGHT cm
	M	20102	710 x 255 x H 270
	L	20103	800 x 255 x H 270

Sun Stop tyre covers



PVC
telato / canvas



COPERTURE DI PROTEZIONE PER RUOTE, 2 PZ

Proteggono gli pneumatici ed i cerchi dal sole, pioggia, sporcizia. Prevengono i danni alla gomma ed al metallo causati dagli agenti atmosferici.

- Contorno elasticizzato per avvolgere e mantenere la copertura aderente alla ruota.
- Cintura di fissaggio con fibbia per fissare la copertura alla ruota
- Impermeabile e lavabile.

WHEEL COVERS, 2 PCS

Protect your tyres and wheels from sun, rain, dirt. Prevent sun, UV, rain and pollutants from damaging the rubber and the metal.

- Elasticized hems to wrap around wheel tightly.
- With belt and adjustable buckle.
- Waterproof and washable.



15925	S	Ø 60-66 cm	(24-26")
15926	M	Ø 69-74 cm	(27-29")
15927	L	Ø 76-81 cm	(30-32")
15928	XL	Ø 84-89 cm	(33-35")
15929	XXL	Ø 91-99 cm	(36-39")
15930	XXXL	Ø 102-107 cm	(40-42")

Scatola / Box 4



2
pcs



COPERTURA DI PROTEZIONE

Per il gruppo "giunto, spinotto, freno" di carrelli o roulotte. Protegge dal sole, pioggia, sporcizia.

Previene l'invecchiamento ed i danni causati dagli agenti atmosferici.

- Con occhielli per passaggio di un eventuale cavo antifurto.
- In dotazione due corde elasticizzate per il fissaggio.
- Impermeabile e lavabile.

TRAILER COUPLING COVER

Protects your trailer and caravan coupling from sun, rain, and dirt. Prevents ageing due to environmental conditions.

- With eyelets for cable lock use.
- 2 elastic cords included.
- Waterproof and washable.

15931 L 91 x H 59 cm

Busta C/Maniglia / Bag 20

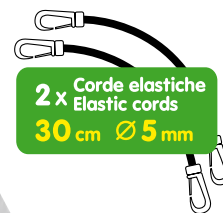
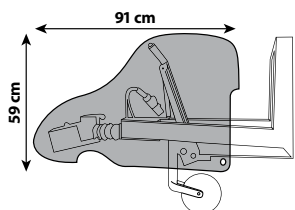

PVC



Con occhielli per cavo antifurto
With eyelets for cable lock use



TAPPO COPRIGANCIO

In morbido PVC con anello e cinghia di ritenzione

PVC TOW-BALL COVER

With retain ring and belt

38970

D/Blister 10 / 100



COPERTURA PER RUOTA DI SCORTA ESTERNA

- Con bordatura di rinforzo.
- Circonferenza interna elasticizzata per un facile montaggio e per una perfetta aderenza al pneumatico.
- Impermeabile, facilmente lavabile.

SPARE TYRE COVER

- With reinforced piping.
- Stretch inner hemline to ensure an easy installation and a tight-fit onto the tyre.
- Waterproof and easily washable.



15935	S	Ø 71 cm	20 cm	223 cm
15936	M	Ø 74 cm	23 cm	232 cm
15937	L	Ø 76 cm	28 cm	239 cm
15938	XL	Ø 78 cm	28 cm	245 cm

Borsina / Bag 10 / 20



PVC
telato / canvas



ELASTICIZZATO - ELASTIC STRETCH





Jockey Wheel

SERVOTIMONI PER RIMORCHI E ROULOTTE
In acciaio zincato

JOCKEY WHEEL FOR TRAILER AND CARAVAN
Galvanized steel

1
pc



max
80
kg

35 \varnothing mm

min. 475 mm
max. 720 mm

160 \varnothing mm

71530 max 80 Kg

Scatola / Box 5



max
150
kg

48 \varnothing mm

min. 490 mm
max. 750 mm

200 \varnothing mm

71531 max 150 Kg

Scatola / Box 5



max
150
kg

48 \varnothing mm

min. 490 mm
max. 750 mm

260 \varnothing mm

71532 max 150 Kg

Scatola / Box 4

**Ruota Gonfiabile
Inflatable Tyre**

Ruote di ricambio Spare wheels

1
pc

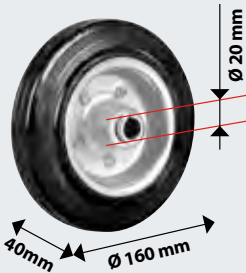

**Ruota Piena
Solid Tyre**

71543 \varnothing 160 mm max 80kg

Busta / Bag 10

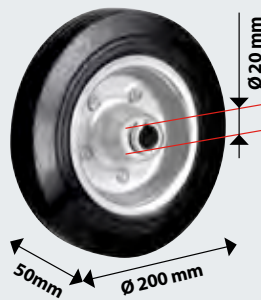

71544 \varnothing 200 mm max 150 kg

Busta / Bag 10



**Ruota Gonfiabile
Inflatable Tyre**

71545 \varnothing 260 mm max 150 kg

Busta / Bag 10



DISPOSITIVI DI BLOCCAGGIO
PER SERVOTIMONI

In acciaio zincato

CLAMPS FOR THE JOCKEY WHEEL
Galvanized steel

71540 \varnothing 35 mm

71541 \varnothing 48 mm

Busta / Bag 24

1
pc



PP-2, COLONNA PORTA CERCHI AUTO

Supporto in grado di sorreggere in poco spazio 4 ruote complete con pneumatici di max 225 mm. Previene la deformazione degli pneumatici. Struttura robusta e stabile con tubi in acciaio. Salvaspazio. Montaggio e smontaggio rapidi.

PP-2, WHEEL RIM AND TYRE STAND

For space-saving storage of 4 complete wheels with tyre having width up to 225mm. It prevents tyres from deterioration. Robust and sturdy tubular steel structure. Easy installation.

15956

Scatola / Box 6

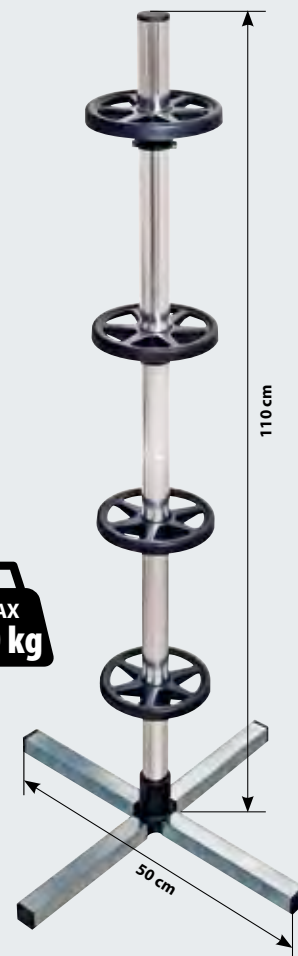

PP-1, ALBERO PER SUPPORTO CERCHI E/O PNEUMATICI

Supporto in grado di sorreggere in poco spazio 4 pneumatici da 13-17", con e senza cerchi. Struttura robusta e stabile con tubi in acciaio. Montaggio e smontaggio rapidi.

PP-1, WHEEL RIM AND TYRE STAND

For space-saving storage of 4 car tyres from 13 to 17 inches, with and without wheels. Robust and sturdy tubular steel structure. Easy installation.

15955

Scatola / Box 4

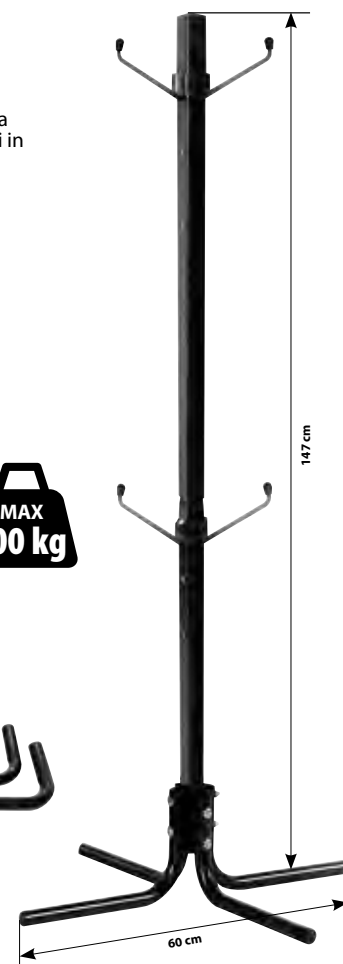

PP-3, CARRELLO PORTA CERCHI E PNEUMATICI CON SUPPORTO AD ASTA

- Salvaspazio, ottima soluzione per lo stoccaggio stagionale.
- Evita la deformazione degli pneumatici
- Per cerchi, pneumatici o ruote complete
- Montaggio e smontaggio rapidi. Con freno ruota
- Portata: 4 ruote complete da 18/19" (max Ø 620 mm), larghezza max 285 mm, peso max 100 kg

PP-3, WHEELED RIM AND TYRE STAND

- Excellent storage and space saving
- Quick assembling and disassembling
- It prevents tyres deformation
- For 4 complete wheels max width 285 mm, 18/19" (max Ø 620 mm), max weight allowed 100 kg.

15957

Scatola / Box 2



**Con freno
With brake**

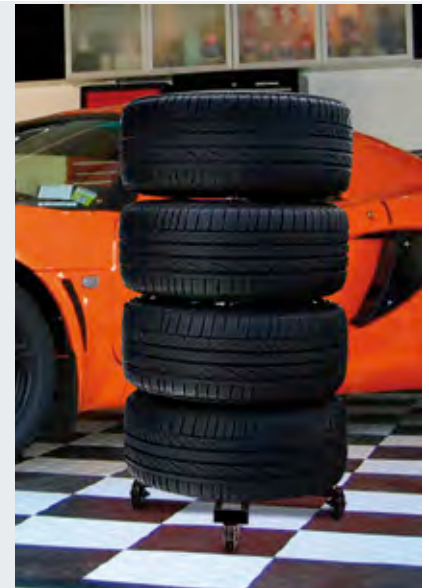
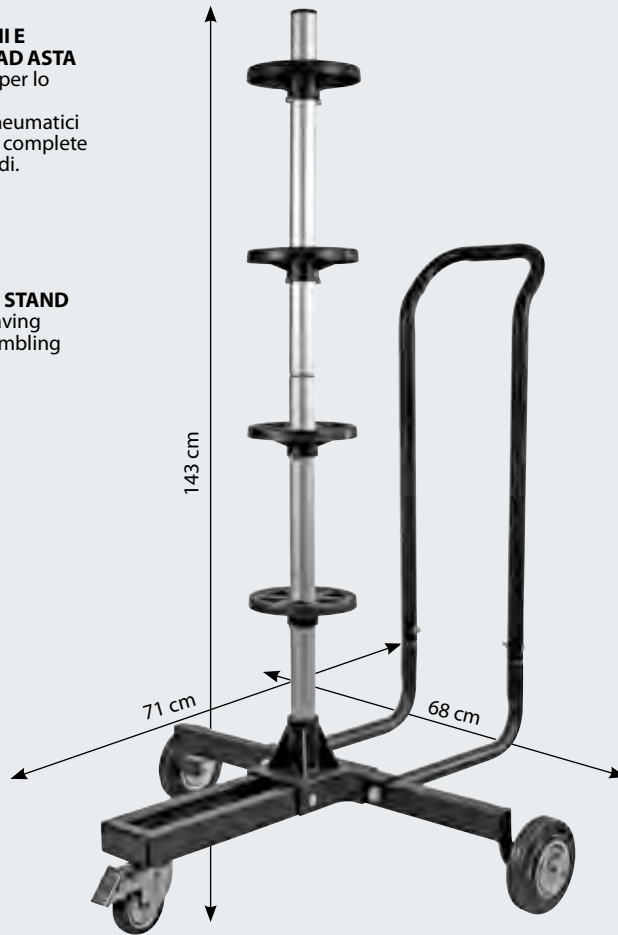

MENSOLA PORTARUOTE DA PARETE

- Ripiegabile, quando non in uso occupa poco spazio.
- Telescopica, larghezza regolabile (90-130 cm).
- Struttura tubolare in acciaio.
- Comprende kit di montaggio con tasselli.
- Portata massima: 90 kg.

FOLDABLE TYRE-RACK

- Wall mount, adjustable width (90-130 cm).
- Strong, durable power coated steel.
- Mounting kit with rawlplugs included
- Max load: 90 kg

15960

Scatola / Box 3



**FISSAGGIO ALLA PARETE
WALL MOUNT**

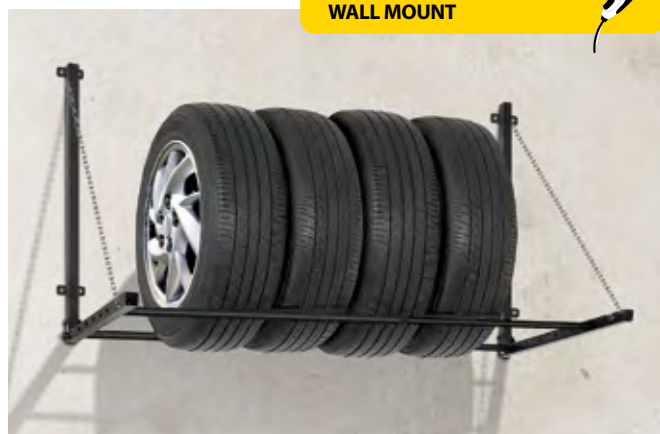

**Telescopica
Adjustable**

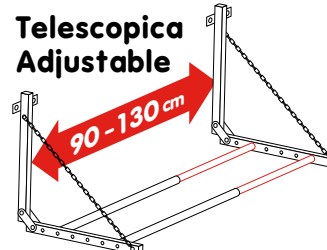

**Ripiegabile
Foldable**

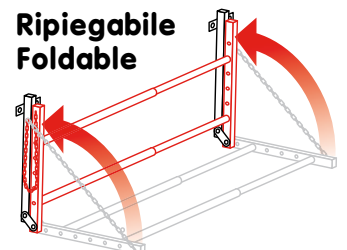

4 pcs Contenuto del set: 4 staffe, 8 tasselli di fissaggio. Foro nel muro Ø 9 mm



WHEEL-HOLDER, SET 4 STAFFE PORTA-RUOTE
Per installazione a parete, tasselli di fissaggio in dotazione. Soluzione salvaspazio per lo stoccaggio di 4 ruote complete con larghezza max 205 mm.

WHEEL-HOLDER FOR WALL MOUNT, SET 4 PCS
Includes fasteners. For 4 complete wheels with width up to 205 mm

15959

Scatola / Box ☐ 5 / 20

MAX 25 kg

Max 205 mm

Tyre Tags

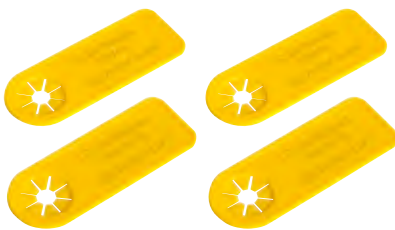

SET 4 SEGNA RUOTE
Indicano la posizione di montaggio delle ruote degli pneumatici al momento del cambio gomme.

4 TYRE TAGS
Point the last position where the wheels pneumatics were mounted before the tyre-change

02490

D / Blister ☐ 10 / 100



Tyre Storage

COPERTURA PER 4 RUOTE
Protegge e mantiene gli pneumatici ed i cerchi puliti quando non in uso.

- Zip laterale per un facile e rapido utilizzo.
- Base con laccio e tirante per una perfetta aderenza agli pneumatici.
- Idrorepellente, lavabile.

TYRES STORAGE COVER
Protects your tyres and wheels during seasonal storage.

- Side ZIP for a quick and easy covering.
- Bottom Lace with stopper for a perfect tight-wrap.
- Water repellent, easily washable.

15945	S	Ø 56 x H 77 cm
15946	M	Ø 66 x H 97 cm
15947	L	Ø 80 x H 117 cm
15948	XL	Ø 90 x H 135 cm

Busta C/Maniglia / Bag ☐ 10 / 50

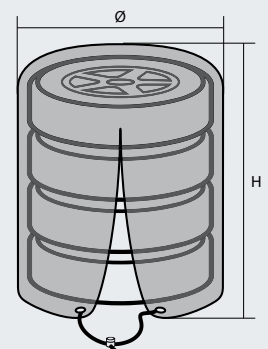

Zip

IDROREPELLENTE
WATER REPELLENT

170T Polyester
Laminato argento
Silver coated

4
pcs

IMPERMEABILE
WATERPROOF



Tyre Wrap

DELUXE

600 D Polyestere

SET 4 COPRIRUOTA
Con maniglia trasporto, indicatore di posizione e tasca porta bulloneria.

- Per avvolgere gli pneumatici e trasportarli facilmente durante il cambio-gomme stagionale evitando di sporcare gli interni dell'auto.
- Per proteggere gli pneumatici durante il loro stoccaggio in garage.
- Possono essere utilizzati su pneumatici con o senza cerchi installati e non compromettono l'utilizzo di alberi o colonne porta-pneumatici.
- Polyestere nero per proteggere la gomma dai raggi solari.
- Impermeabili e lavabili.

SET OF 4 TYRE COVERS
With carry handle, mounting position marking and bolts pocket.

- For wrapping the tyres and transporting them without making car interiors dirty.
- Ideal also for protecting tyres from damaging UV rays, for carrying and for storage during seasonal tyre change.
- Made from tear-proof, waterproof and washable polyester.

15941 L Ø 73 x 35 cm 13"-19"

Borsina / Bag  5 / 10



Tyre Wrap Basic

POLYESTER 170D

Size L - 13"-19"



TYRE WRAP BASIC - SET 4 COPRIRUOTA

Con maniglia di trasporto e indicatore di posizione.

- Per avvolgere gli pneumatici e trasportarli facilmente durante il cambio gomme stagionale evitando di sporcare gli interni dell'auto.
- Per proteggere gli pneumatici durante il loro stoccaggio in garage.
- Possono essere utilizzati su pneumatici con o senza cerchi installati e non compromettono l'utilizzo di alberi o colonne porta-pneumatici.
- Poliestere nero per proteggere la gomma dai raggi solari.
- Impermeabili e lavabili.

TYRE WRAP BASIC - SET OF 4 TYRE COVERS

With carry handle and mounting position marking

- For wrapping the tyres and transporting them without making car interiors dirty.
- Ideal also for protecting tyres from damaging UV rays, for carrying and for storage during seasonal tyre change.
- Made from tear-proof, waterproof and washable polyester.

15940 L 13"-19"

Busta / Bag  12 / 24



GARAGE LIFT, SISTEMA DI SOLLEVAMENTO PER GARAGE

È un valido aiuto per tenere sempre in ordine il vostro garage. Idoneo per box porta tutto, kayak, canoe, biciclette e scale. Massima portata: 45 kg. Montaggio su trave oppure direttamente al soffitto. Kit di montaggio incluso

GARAGE LIFT, SPACE-SAVER-SYSTEM

Helps to organize your garage and frees up much needed floor space. Excellent for car roof boxes, kayaks, canoes, bicycles or ladders weighing under 45 kg. Easy mounting system: separate brackets mount directly to joists or to ceiling. Mounting kit included

62099Scatola / Box  10
FISSAGGIO AL SOFFITTO
CEILING MOUNT
**UPPER-DECK, BARRE PORTATUTTO PER GARAGE**

- Specifiche per ottimizzare e sfruttare in altezza lo spazio disponibile.
- Applicate alle pareti laterali, le barre creano una rastrelliera sopraelevata dove si possono collocare tutti gli oggetti lunghi (box tetto, sci, scale...).
- È inoltre possibile dotare le barre di un ripiano (non in dotazione) per riporre anche gli oggetti piccoli o scatole.
- Prodotte in acciaio tubolare con estensione telescopica fino ad una larghezza di 330 cm.
- Facili da montare (tasselli inclusi).

UPPER-DECK, GARAGE-RACK

- Great for creating extra storage for ladders, planks, piping, ski, etc.
- Steel tubes slide to suit width of most single/double garages.
- Easy to install (screws included).

62100 170x20 cmScatola / Box  2

È possibile dotare le barre di un ripiano in legno/plastica o altro (non in dotazione), per riporre anche gli oggetti piccoli o scatole.

Telescopiche
170 ÷ 330 cm

FISSAGGIO ALLA PARETE
WALL MOUNT

Max 45 kg
GARAGE WALL ORGANIZER

I suoi comodi appendini aiutano a mantenere in ordine il garage. Ideale per scope, attrezzi, sci, cavi, vestiti, ombrelli... Fissaggio tramite tasselli (in dotazione), portata massima 45 kg. Solo per uso interno

GARAGE WALL ORGANIZER

Storage system for hanging what is commonly stored inside the garage. These handy hooks and hangers make it simple the hanging skis, tools, brooms, cables, clothes, umbrellas, etc... Rawlplugs included. Max load 45 kg, indoor use only

92899 55,4x8,5x12 cmScatola / Box  6

**PARKING BLOCK STRONG, BARRIERA PER PARCHEGGIO**

- Protezione per posto auto.
- Struttura in acciaio spesso e resistente.
- Di facile utilizzo.
- Montante a sezione quadra.
- Fissaggio a staffa centrale per 4 tasselli a pavimento.
- Serratura di chiusura incorporata nella base del blocco.

PARKING BLOCK STRONG, PARKING BARRIER

- Parking place protection.
- Heavy duty sturdy structure.
- Efficient and simple to use.
- Locking mechanism included into the square section mast.
- Easy installation, fitting hardware included.

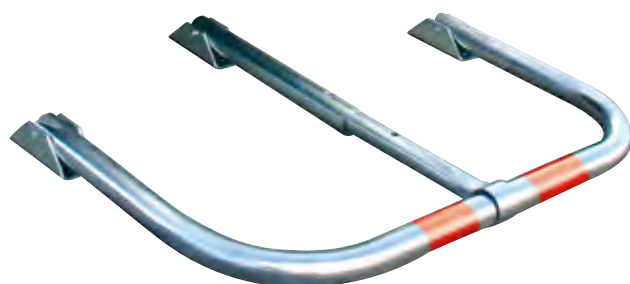
62106 74 x 46 cmScatola / Box  2
Con serratura di chiusura
With locking mechanism
**PARKING-BLOCK, BARRIERA DI PARCHEGGIO**

Protezione per posto auto, semplice ma efficace: 6 tasselli di ancoraggio a pavimento. Tubo zincato da 35x2 mm

PARKING-BLOCK, SECURITY PARKING BARRIER

Parking place protection. Efficient and simple to use. Easy installation, fitting hardware included. Galvanized 35x2 mm steel pipes

62103 75 x 40 cmScatola / Box  2
Con lucchetto
With lock

BARRIERA DI PARCHEGGIO AUTOMATICA CON TELECOMANDO

Protegge l'accesso al proprio posto auto.
Facile da installare e di semplice utilizzo, basta premere il telecomando per alzare o abbassare la barriera.
Alimentata con batteria ricaricabile 6V con durata di circa 1000 utilizzi (circa 9 mesi di autonomia).
Allarme sonoro in caso di tentativo di manomissione.

AUTOMATIC PARKING BARRIER WITH REMOTE CONTROL

Simple to install and easy to use automatic parking lock.
With the touch of your remote control lower your automatic parking lock or parking barrier to lay flat, allowing you to drive your vehicle into your parking space.
Powered by 6V rechargeable battery. It will last for about 1000 uses, or about 9 months continuous use



Batteria
Battery



Batteria + Pannello Solare
Battery + Solar Panel

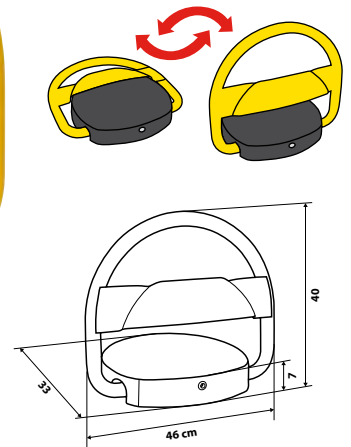

62107 Batteria
Battery

Scatola / Box 1

62108 Batteria + Pannello solare
Battery + Solar Panel

Scatola / Box 1

Accessori in dotazione:

- Batteria 6V.
- Due telecomandi.
- Doppia chiave per la rimozione della copertura.
- Caricabatteria.
- Tasselli per il fissaggio al pavimento.

Included accessories:

- 6V battery.
- Two remote controls.
- Two keys to remove the cover.
- Recharging power pack.
- Floor fixing screws.



Batteria estraibile e ricaricabile tramite caricabatteria incluso
Removable and rechargeable battery

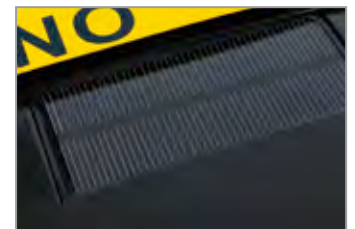

La versione con pannello solare aumenta la durata della batteria
The barrier with solar panel extends the battery charge life

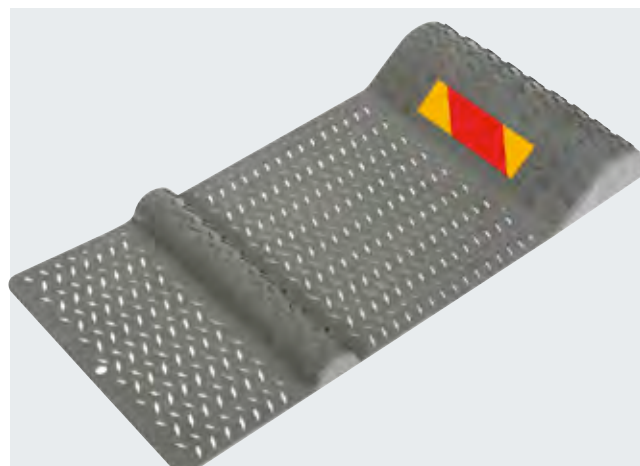

AUTO-PARK

Delimitatore di parcheggio per garage. Base adesiva per il fissaggio al pavimento senza praticare fori

PARKING STOP SIGN
Adhesive base.

62101 52x25 cm

Busta / Bag 10





2 pcs

FASCIONI-PARAURTI ADESIVI PER GARAGE

2 pezzi da 45 cm, morbida gomma espansa, da applicare sulle pareti del garage.

ADHESIVE BUMPER AND DOOR PROTECTORS

2x45 cm. Easily stick onto garage walls.

62102 2 x 45 cm

Busta / Bag 10 / 40



SPESSORE / THICKNESS
4 mm Spessore

200 x 20 cm

ADHESIVE
EVA foam

BUMP-MAT MULTIUSE, PROTEZIONE ADESIVA MULTIUSO

Per pareti garage e per tutte le superfici di contatto dove si rende necessaria una protezione

BUMP-MAT MULTIUSE, ADHESIVE PADDING MAT

For garage walls, doors or any surfaces and situations where soft protection is needed.

62097

Termoretraibile / Thermo 20



DIN76051-E36

1 pc



**CALZATOIA TERMOPLASTICA OMOLOGATA
HOMOLOGATED THERMOPLASTIC CHOCK**

97873 Giallo Yellow

Sfuso / Bulk 1

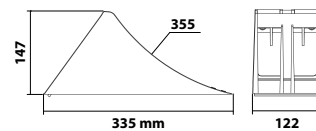

2 pcs

COPPIA CUNEI FERMARUOTA

Per bloccare il veicolo durante le riparazioni o il sollevamento o per fermarlo in un punto di arresto prestabilito. Per superare marciapiedi, gradini...

2 WHEEL CHOCKS

For chocking the vehicle during lifting or parking. For driving up steps or pavements with sharp edges or setting a barrier for parking into garage

62104

Sfuso / Bulk 6 / 24



2 pcs

Conformi alla normativa
Meets Standards
DIN76051-1 (1992-11)
1000 Kg Max

CUNEI FERMARUOTA

Multiuso per auto, camper, roulotte... Con staffe di ancoraggio al pavimento.

WHEEL CHOCKS

Multiuso for car, camper, roulotte... Includes floor anchor plates.

62110

Scatola / Box 20



Viti di fissaggio include
Fixing screws included

Vigilant



VIGILANT, SERRATURA AGGIUNTIVA PER PORTE VEICOLI COMMERCIALI

- Idoneo per porte a scorrimento e battenti.
- Area applicazione della piastra di aggancio con 6 punti di fissaggio, migliora la tenuta anti strappo dalle lamiere delle porte.
- Tre sistemi di montaggio in dotazione: tramite bulloni e dadi, con rivetti, oppure con bulloni e dadi rivettati a pressione.
- 2 chiavi in dotazione.
- Perno conico auto-centrante per recuperare i disallineamenti delle porte

VIGILANT, ADDITIONAL LOCK FOR COMMERCIAL VEHICLES

- Suitable for sliding and swing doors.
- Metal plates reinforced with 6 fix-points to ensure a strong anchor on door panels.
- Three mounting systems supplied.
- 2 keys.
- Conical self-centring central pin to compensate the doors mis-alignments

65411	Kit 1 serratura	1 lock kit	Scatola / Box	12
65412	Kit 2 serrature	2 locks kit	Scatola / Box	6

Scatola / Box 12

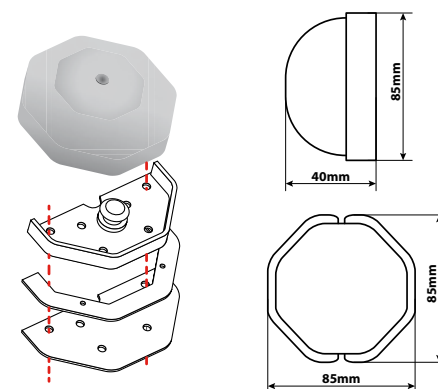

Il kit di installazione contiene:

- Piastre di ancoraggio;
- Viti, bulloni, rondelle e rivetti;
- Dima adesiva di foratura;
- Chiave esagonale per installazione

The installation kit contains:

- Anchoring plates;
- Screws, bolts, washers and rivets;
- Adhesive drilling template;
- Hexagonal key for installation



PORTE POSTERIORI BATTENTI REAR LEAF DOORS



PORTA LATERALE SCORREVOLE SIDE SLIDING DOOR



Piastre di fissaggio con robusti perni in acciaio inox con tolleranza delle ante

Fixing plates with strong stainless-steel pins which allows movements of the doors

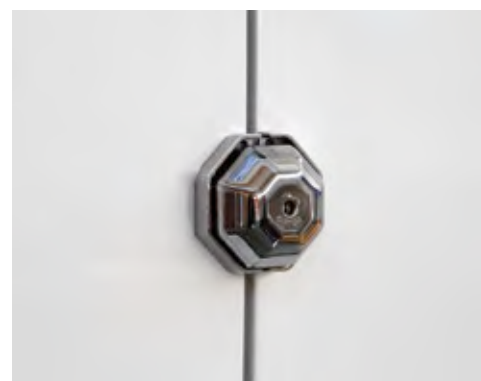

Van Lock

MADE IN ITALY



Innovativo sistema di chiusura per furgoni e camion con forma esclusiva (brevettata) priva di spigoli e punti di presa, realizzato in acciaio inox, applicabile indifferentemente sulle porte posteriori a battente e su quelle laterali a scorrimento, oppure su entrambe, acquistando il set 2 pezzi con la stessa chiave.

Innovative locking system for trucks and vans with special (patented) shape without sharp edges or gripping points, made in corrosion-proof inox stainless steel, can be applied to rear wing doors or side sliding doors, or both, in the pair version with the same key.

Antistrappo • Antiperforazione • Anticorrosione



VAN LOCK, CHIUSURA DI SICUREZZA PORTE VEICOLI COMMERCIALI

- Rimane fissato alla porta. Con chiusura automatica a spinta senza bisogno della chiave. Ideale per chi effettua ripetute aperture giornaliere.
- Area applicazione della piastra di aggancio con 4 punti di fissaggio, migliora la tenuta anti strappo dalle lamiere delle porte.
- 3 chiavi Viro top security (duplicabili) dalla comoda impugnatura anche con guanti da lavoro pesanti.
- Barilotto (sostituibile) in ottone a 7 pistoncini protetto da piastrina in acciaio cementato, temprato, ramato, nichelato e cromato contro lo scasso ed il trapano.
- Perno conico auto-centrante per recuperare i disallineamenti delle porte

VAN LOCK, SAFETY DOOR LOCK FOR VAN

- Stays put on the door. Self-locking keyless function. Ideal for repeated opening and closing such as courier or mail services.
- Metal plates reinforced with 4 fix-points to ensure a strong anchor on door panels.
- 3 duplicable top security Viro keys with glove-friendly grip.
- Drill-proof replaceable cylinder lock with 7 pins, protected by hardened and steel plate.
- Conical self-centring central pin to compensate the doors mis-alignments

65406	Set 1 pezzo	1 pc set
--------------	-------------	----------

65407	Set 2 pezzi	2 pcs set
--------------	-------------	-----------

Scatola / Box  5

Il kit di installazione contiene:

- Piastre di ancoraggio;
- Viti, bulloni, rondelle in acciaio inox e rivetti;
- Dima adesiva di foratura;
- Spessori in acciaio inox per recupero di eventuali disallineamenti fra le ante;
- Guarnizione in gomma antigraffio.

The installation kit contains:

- Anchoring plates;
- Inox stainless steel screws, bolts, washers and rivets;
- Adhesive drilling template;
- Inox stainless steel spacers to compensate any misalignments between the doors;
- Non-scratch rubber seal.



Apertura di emergenza dall'interno
Allows emergency opening from the interior

DOPPIE PORTE POSTERIORI
TWIN REAR DOORS



PORTA LATERALE
SCORREVOLE
SIDE SLIDING DOOR



Piastre di fissaggio
Fixing plates



Robusto perno conico in acciaio inox
che tollera movimenti delle ante
Strong conical stainless-steel pin
which allows movements of the doors



Adattatori *Adapters*

SET PIASTRE ADATTATRICI + ACCESSORI
DI MONTAGGIO

Per l'installazione dell'antifurto "Van-Lock" su camion e furgoni cassonati.

SET ANCHOR PLATES + FITTING ACCESSORIES

For the installation of the "Van-Lock" on vans and trucks with rigid doors

65408

Scatola / Box 5

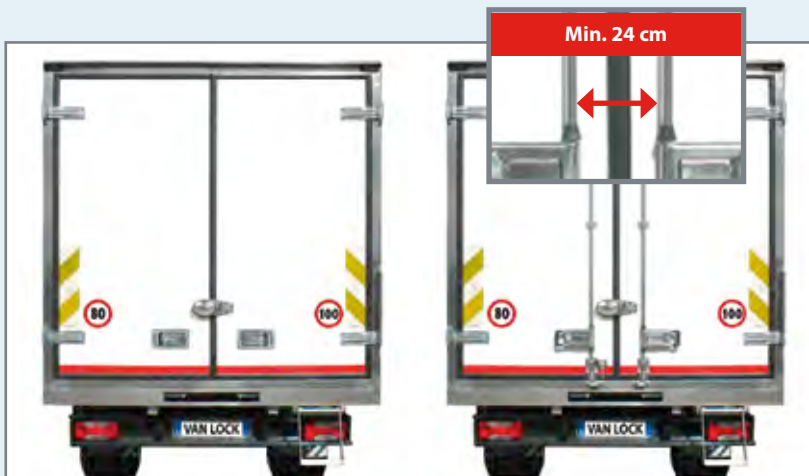

Veicoli dotati di 1 o 2 aste di chiusura, sia interne che esterne
Vehicles equipped with 1 or 2 lock-bolts (internal and external)



OK CONTAINER

Basic

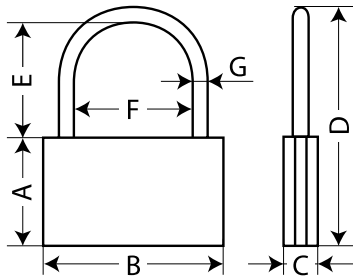

XL

BASIC, LUCCHETTO IN OTTONE
3 chiavi in dotazione.

BASIC, BRASS PADLOCK
With 3 keys.

Art.	BASIC	A (mm)	B (mm)	C (mm)	D (mm)	E (mm)	F (mm)	G (mm)	Imballo / Packaging
65425	30 mm	20	30	8	42	18	16	Ø 4	D/Blister 12 / 360
65426	40 mm	24	40	9	53	24	22	Ø 5	D/Blister 12 / 120
65427	50 mm	30	49	11	67	31	30	Ø 6	D/Blister 12 / 120
65428	50 mm XL	30	49	11	108	72	30	Ø 6	D/Blister 12 / 120
65429	60 mm XL	35	59	12	116	75	33	Ø 6	D/Blister 12 / 120

Standard

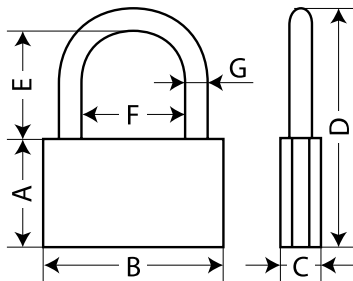

XL

STANDARD, LUCCHETTO IN OTTONE
3 chiavi in dotazione.

STANDARD, BRASS PADLOCK
With 3 keys.

Art.	STANDARD	A (mm)	B (mm)	C (mm)	D (mm)	E (mm)	F (mm)	G (mm)	Imballo / Packaging
65420	40 mm	32	38	12	61	23	19	Ø 6	D/Blister 12 / 120
65421	50 mm	36	49	15	75	31	26	Ø 8	D/Blister 12 / 60
65422	60 mm	40	58	17	85	37	32	Ø 8,5	D/Blister 10 / 40
65423	40 mm XL	32	38	12	100	62	19	Ø 6	D/Blister 12 / 120
65424	50 mm XL	36	49	15	109	65	26	Ø 8	D/Blister 10 / 50



LUCCHETTO IN OTTONE A COMBINAZIONE VARIABILE
Serratura a 3 cifre.
1000 differenti combinazioni selezionabili a scelta

RESETTABLE BRASS PADLOCK
3 digit lock.
1000 resettable combinations

65432 40 tmm

D/Blister 6 / 72

1.000
Differenti
Combinazioni

0 0 0
Serratura a 3 cifre
3 digits lock

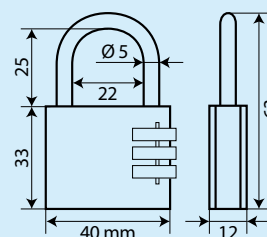



**Per Bulloni e Prigionieri
For Bolts and Nuts**



DADO ANTIFURTO PER RUOTA DI SCORTA

Adatto a tutte le ruote di scorta esterne. 2 chiavi incluse. Può essere usato come antifurto anche al di fuori dell'ambito automobilistico su tutti i bulloni e prigionieri che rientrano nelle misure massime indicate

SPARE WHEEL LOCK

Fits all side mount spare tires. 2 keys included. It can be used as a lock for bolts and nuts also outside the automotive field

02469

D/Blister 12 / 48

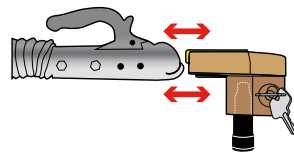
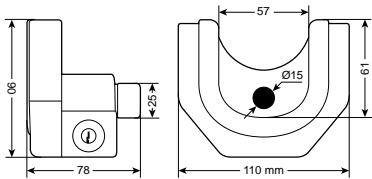

ANTIFURTO PER GANCIO RIMORCHI

Ideale per prevenire il furto di rimorchi e caravan. Adatto per i ganci traino standard. In acciaio, resistente alla corrosione. 2 chiavi incluse

TRAILER LOCK

Suitable for preventing the theft of trailers and caravans. Specific for standard trailer hook. Made of steel, corrosion resistant. 2 keys included

65404

D/Blister 6 / 12



ANTIFURTO PER GIUNTO A SFERA

Facile e rapido da utilizzare. Si inserisce nel giunto a sfera. Previene l'aggancio del rimorchio. 2 chiavi in dotazione

COUPLER LOCK

Easy and quick to install. Locks into the coupler and prevents the coupling. 2 keys

65403

D / Blister 5 / 10



ANTIFURTO PER GIUNTO A SFERA

Universale Ø 50 mm. Facile e rapido da utilizzare. Si inserisce nel giunto ed impedisce l'inserimento della sfera nel gancio. 3 chiavi in dotazione.

TRAILER HITCH LOCK

Universal Ø 50 mm. Easy and quick to install. Prevents attachment to a towing vehicle. 3 keys included.

65401

D/Blister 12

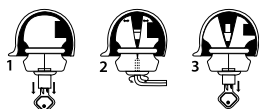

Block-Master



BLOCK-MASTER 2000 BLOCCAVOLANTE
 Lega di metallo rinforzato, serratura a 4 intagli, 3 chiavi. Barra plastificata antigraffio

BLOCK-MASTER 2000, STEERING WHEEL LOCK
 Special keys. Anti-scratch plastic coated metal bar

65379

D/Blister 6



Zanna-Lock



ZANNA-LOCK, ANTIFURTO BLOCCASTERZO
 Facile da installare e da rimuovere. Si posiziona in pochi secondi sul volante e si chiude automaticamente senza agire sulla chiave. Rivestito in morbida plastica per evitare graffi. Altamente visibile dall'esterno quando installato.

ZANNA LOCK, STEERING WHEEL LOCK
 Easy to install and remove. It fits in few seconds on the steering wheel and it locks automatically when the tusks are closed. All contact surfaces are vinyl-soft-coated to prevent scratches to dashboard and steering wheel. Highly visible when installed.

65399

D/Blister 6

Elefant-Lock

Doppio uso Antifurto vettura e airbag
Double use, anti-theft device for car and airbag

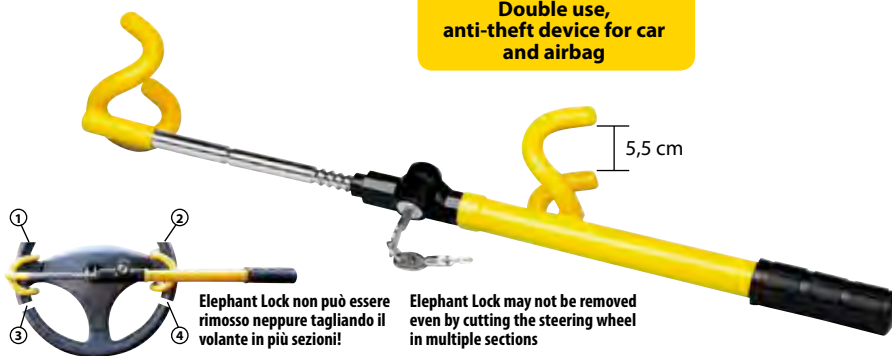

Elefant Lock non può essere rimosso neppure tagliando il volante in più sezioni!

Elefant Lock may not be removed even by cutting the steering wheel in multiple sections

ANTIFURTO ELEFANT LOCK
 Bloccavolante corazzato, con doppia zanna. Non può essere rimosso neppure tagliando il volante. Evita anche il furto dell'airbag

ELEFANT LOCK
 Steering wheel and airbag lock.

65373

D/Blister 4 / 8



Dura Block

Doppio uso Antifurto vettura e airbag
Double use, anti-theft device for car and airbag



DURA BLOCK non può essere rimosso neppure tagliando il volante in più sezioni!

DURA BLOCK may not be removed even by cutting the steering wheel in multiple sections

DURA BLOCK, ASTA BLOCCASTERZO ED ANTIFURTO PER AIRBAG
 Universale e compatta. Installazione e rimozione ultra rapida, con meccanismo di blocco automatico. Rivestita in morbida plastica per prevenire graffi e idonea per tutti i volanti con e senza airbag. 2 chiavi in dotazione

DURA BLOCK, STEERING WHEEL LOCK
 Self-locking system. 2 double-tusks for extra-security. Compact size, can be easily stored under car seat. Hardened steel and fully plastic coated to prevent scratches on steering wheels and car interiors. Universal. 2 keys included

65400

D/Blister 4 / 8



Ok-Lock

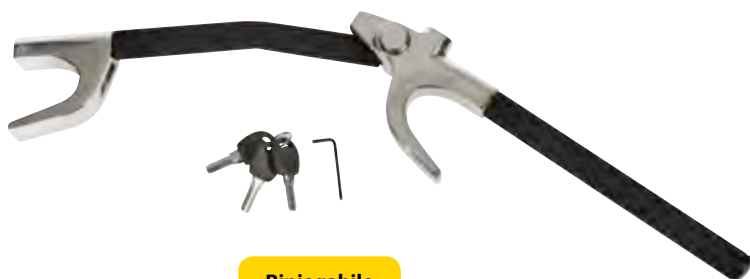

**Ripiegabile
Foldable**

OK-LOCK SECURITY
Asta bloccasterzo ripiegabile in acciaio temprato, anti-taglio e serratura antiscasso. Installazione ultrarapida, con blocco automatico. Rivestimento in gomma-spugna e finitura al cromo

OK-LOCK SECURITY
High-security steering wheel lock
Self-locking system, extremely compact size. Hardened steel anti-saw foldable frame and lock. Special rubberized grip. Chromed-Alloy finish

65372

Scatola / Box 5



Asta volante-pedale



ASTA BLOCCASTERZO-PEDALE
Doppia chiave in dotazione.

PEDAL STEERING-WHEEL LOCK
Two keys included.

65380

D/Blister 6 / 12



Asta volante



ASTA ANTIFURTO A VOLANTE
Doppia chiave in dotazione.

STEERING WHEEL LOCK
Two keys included

65381

D/Blister 6



Pedal-Stop



**DISTANZA TRA PEDALI
FRENO E FRIZIONE:
MAX 18,5 CM**

PEDAL STOP, ANTIFURTO BLOCCAPEDALI

Blocca frizione e freno.
Telescopico, regolabile in
larghezza. Doppia chiave
in dotazione

ANTI THEFT PEDAL LOCK
With new function
allowing width adjustment
to fit most cars

65394

D/Blister 4 / 8



Wheel Clamp

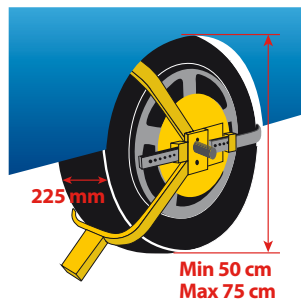

WHEEL CLAMP, GANASCIA IMMOBILIZZA-VEICOLO

- Si applica ad una ruota anteriore e immobilizza il veicolo impedendone il movimento.
- Ideale per auto, roulotte, rimorchi...
- Universale per tutte le ruote da Ø 13" a 18" con larghezza fino ad un massimo di 225 mm.
- Con disco coprimozzo per impedire lo svitamento dei bulloni della ruota (non installabile su pneumatici larghi).
- Serratura speciale con copertura impermeabile e doppia chiave in dotazione.
- Ripiegabile, occupa poco spazio quando non in uso.

WHEEL CLAMP, UNIVERSAL FOLDING WHEEL CLAMP

- Ideal for immobilizing most vehicles.
- Suitable for cars, vans, caravans, trailers...
- Universal for all the wheels from 13" to 18" Ø with width up to a maximum of 225 mm.
- High security pick resistant lock.
- Dust, water and corrosion proof.
- Security disk prevents access to wheel nuts (not for wide tyres).
- Folds for easy storage

65405

Scatola / Box 2



PNEUMATICI STRETTI - NARROW TYRES



PNEUMATICI MEDI - NORMAL TYRES

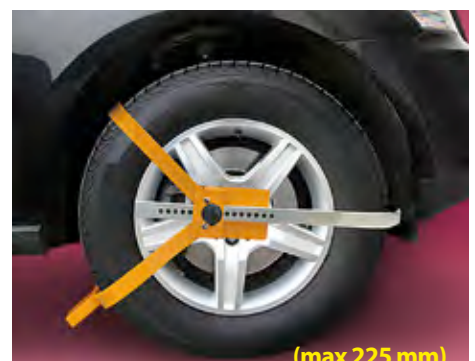

(max 225 mm)

PNEUMATICI LARGHI - WIDE TYRES



Nylon

Lega di Alluminio
Aluminium Alloy

MOTOR-SPORT, FILTRO CARBURANTE

Con terminali intercambiabili. La trasparenza permette di verificare lo stato del filtro interno. Riutilizzabile: Il filtro può essere aperto, pulito e reinstallato.

MOTOR-SPORT, CLEAR FLOW FILTER
With interchangeable terminals. Transparent type for visible status

70157 Ø 4, 8, 16 mm

D/Blister 12 / 72

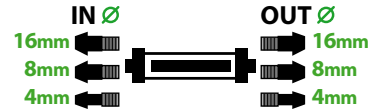

POWER, FILTRO BENZINA COMPETIZIONE

In lega di alluminio. Apribile per le operazioni di pulizia
POWER, ALUMINIUM FUEL FILTER
Can be opened for cleaning

70155 Ø 8 mm

D/Blister 25 / 100

BENZINA
PETROL



FILTRO CARBURANTE UNIVERSALE - BENZINA, GRANDE
UNIVERSAL FUEL FILTER - PETROL, LARGE

70150 Ø 6/8 mm

Blister 40



FILTRO CARBURANTE TRASPARENTE

Con terminali in lega di metallo cromato. Permette il controllo dello stato del filtro. Apribile per le operazioni di pulizia

PERFORMANCE FILTER
Transparent type for visible status. Re-usable, may be opened cleaned and reinstalled

70156 Ø 8 mm

D/Blister 12 / 72

BENZINA
PETROL



FILTRO CARBURANTE UNIVERSALE - BENZINA, PICCOLO
UNIVERSAL FUEL FILTER - PETROL, SMALL

70160 Ø 6/8 mm

Blister 120

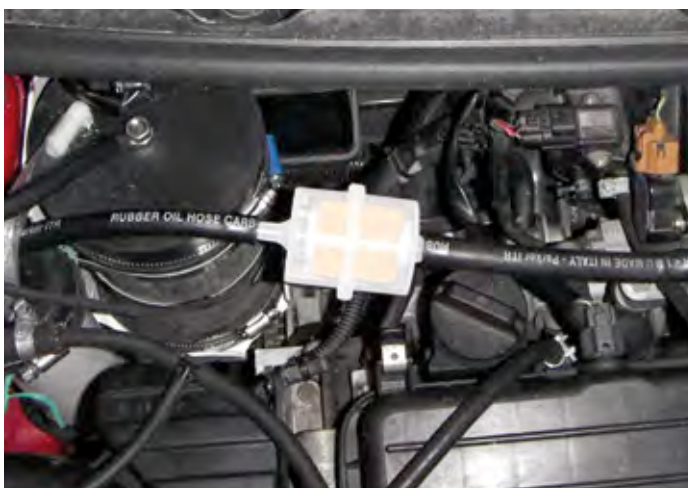

DIESEL



FILTRO CARBURANTE UNIVERSALE - DIESEL
UNIVERSAL FUEL FILTER - DIESEL

70170 Ø 6/8 mm

Blister 120

Mini Air-Filters

Mini-Filtri aria sportivi ad alte prestazioni.
Per collettori di aspirazione Ø 12 mm
Montaggio diretto sul collettore.
Di facile montaggio tramite cinghia in acciaio.
Look esclusivo. Maggiore potenza ad alti regimi
grazie al flusso di aria diretto senza strozzature.
Ottimo filtraggio dell'aria aspirata

Direct fitting onto air intake.
Easy mount through steel strap
Exclusive racing look
Higher performance thanks to direct free-flow air
input without any constriction
Accurate air filtration

Articolo Article	Altezza Height mm	Base Base Ø mm	Attacco Fitting Ø mm
06097	40	60	12
06098	40	50	12
06099	70	75	12



FILTRO ARIA CONICO Ø 12 MM
CONIC AIR FILTER Ø 12 MM

06097

D/Blister 10 / 100



FILTRO ARIA CILINDRICO Ø 12 MM
CYLINDRIC AIR FILTER Ø 12 MM

06098

D/Blister 10 / 100



FILTRO ARIA CILINDRICO Ø 12 MM
CON PROTEZIONE CALORE
CYLINDRIC AIR FILTER Ø 12 MM
WITH HEAT SHIELD

06099

D/Blister 10 / 100



Articolo Article	Altezza Height mm	Base Base Ø mm	Attacco Fitting Ø mm
06120 - 06122	100	145	60 - 90



AF-4, FILTRO ARIA IN SPUGNA
AF-4, FOAM TYPE AIR FILTER

06120

Rosso Red

06122

Blu Blue

Scatola / Box 6 / 24



SUPER-CHARGE, FILTRO ARIA SPORTIVO
AD ALTE PRESTAZIONI IN ACCIAIO INOX
Di facile montaggio tramite collari in lega di alluminio
direttamente sul collettore. Suono sportivo, look esclusivo.
Maggiore potenza ad alti regimi grazie al flusso di aria diretto
senza strozzature. Ottimo filtraggio dell'aria aspirata

SUPER-CHARGE, STAINLESS-STEEL SPORT AIR-FILTER

Direct fitting onto air intake. Easy mount through aluminium
collars. Sport sound, exclusive racing Look. Higher performance
thanks to direct free-flow air input without any constriction.
Accurate air filtration

06130

Scatola / Box 10

Articolo Article	Altezza Height mm	Base Base Ø mm	Attacco Fitting Ø mm
06130	230	150	60 / 80



Super-Charge

Sport Air-Filters

Universali per la maggior parte delle vetture. Montaggio diretto sul collettore tramite fascetta in acciaio inox e set di adattatori. Suono sportivo e look esclusivo. Maggiore potenza ad alti regimi grazie al flusso d'aria diretto senza strozzature. Ottimo filtraggio dell'aria aspirata. 2 anni di garanzia.

Fits most cars. Direct fitting onto air intake through stainless steel strap and adapters. Exclusive racing look and sport sound. Higher performance thanks to direct free-flow air input without any constriction. 2 years guarantee

Af-2



AF-2, FILTRO ARIA CONICO
AF-2, CONIC AIR FILTER
06100

Scatola / Box 6 / 24

Af-1



SPUGNA
FOAM TYPE

AF-1, FILTRO ARIA CONICO IN SPUGNA
AF-1, CONIC AIR FILTER, FOAM TYPE
06105

Scatola / Box 6 / 24



FILTRO ARIA CARBON-LOOK
CARBON-LOOK AIR FILTER
06108

Scatola / Box 4 / 12



FILTRO ARIA CHROME-LOOK
CHROME-LOOK AIR FILTER
06109

Scatola / Box 4 / 12

Af-3



TWIN
AIR
SYSTEM

AF-3, FILTRO ARIA CONICO
AF-3, CONIC AIR FILTER
06110

Scatola / Box 6 / 24

Tecnologia - IN-MOULD - Technology



Acciaio Inox
Stainless Steel

FILTRO ARIA CONICO
CONIC AIR FILTER
06115

Scatola / Box 6 / 24



Fibra di Cotone
Cotton fiber

FILTRO ARIA CONICO
CONIC AIR FILTER
06116

Scatola / Box 6 / 24

Articolo Article	Altezza Height mm	Base Base Ø mm	Attacco Fitting Ø mm
06100	150	122	60-90
06105	150	123	60-90
06108 - 06109	135	160	60-114
06110	152	155	60-90
06115	120	150	60-90
06116	162	122	60-90



Tutti i filtri sono
forniti con un kit di
adattatori universali
Universal adapters kit
included in each filter

Af-9



AF-9, FILTRO ARIA CONICO
AF-9, CONIC AIR FILTER

06111

Scatola / Box 6 / 24

Af-10



AF-10, FILTRO ARIA CONICO
AF-10, CONIC AIR FILTER

06112

Scatola / Box 6 / 24

Af-11



AF-11, FILTRO ARIA CONICO
AF-11, CONIC AIR FILTER

06113

Scatola / Box 6 / 24

Af-12



AF-12, FILTRO ARIA CONICO
AF-12, CONIC AIR FILTER

06114

Scatola / Box 6 / 24

Articolo Article	Altezza Height mm	Base Base Ø mm	Attacco Fitting Ø mm
06111	195	155	60-90
06112	160	155	60-101
06113	165	155	60-101
06114	160	155	60-101



06140

D/Blister 8



KIT DI MONTAGGIO FILTRO SPORTIVO AD ASPIRAZIONE DIRETTA, UNIVERSALE

Kit composto da:

- 1 tubo alluminio diretto - 50 cm, Ø 75 mm
- 1 tubo alluminio curvo a gomito - 45° Ø 75 mm
- 1 tubo alluminio curvo a gomito - 90° Ø 75 mm
- 2 staffe di ancoraggio
- 1 raccordo in gomma - Ø 75 mm
- 1 raccordo in gomma - Ø 75 mm > Ø 65 mm
- 1 fascetta in acciaio inox - 72-95 mm
- 3 fascette in acciaio inox - 78-101 mm
- 1 raccordo da quadrato a rotondo

HIGH-FLOW AIR FILTER MOUNTING KIT, UNIVERSAL

Kit includes:

- 1 aluminium pipe - 50 cm - Ø 75mm
- 1 aluminium knee 45° - Ø 75 mm
- 1 aluminium knee 90° - Ø 75 mm
- 2 anchor brackets
- 1 rubber link - Ø 75 mm
- 1 rubber link - Ø 75 mm > Ø 65 mm
- 1 hose strap - 72-95 mm
- 3 hose straps - 78 -101 mm
- 1 transition fitting from square to round



RACCORDO FILTRO ARIA IN ALLUMINIO
ALUMINIUM AIR-FILTER ADAPTER

06150 Bosch type

D/Blister 10 / 50

PILOT - PERFORMANCE

PILOT-PERFORMANCE, FILTRI ARIA AD ALTE PRESTAZIONI

Progettati per garantire una maggiore portata d'aria e potenza ad alti regimi grazie al flusso d'aria diretto, senza strozzature. Ottimo filtraggio dell'aria aspirata. Suono sportivo e look esclusivo. Lavabili e riutilizzabili più volte per una lunga durata e per un risparmio nei costi.

PILOT-PERFORMANCE, HIGH-FLOW AIR FILTERS

Designed to optimize air-flow volume and higher performance thanks to direct free-flow air input without any constriction. Accurate air filtration. Exclusive racing look. Washable, reusable for an extreme long life.



PILOT PERFORMANCE, MINI FILTRO ARIA

Per collettori da Ø 12 mm. Carenatura para-calore.

PILOT PERFORMANCE, MINI AIR FILTER

Fits into Ø 12 mm air intakes. With heat-protective shield.

06700

Scatola / Box 10 / 100

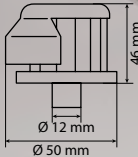

PILOT PERFORMANCE AF-5, FILTRO ARIA CONICO

Montaggio diretto in collettori da Ø 60 mm.

PILOT PERFORMANCE AF-5, CONIC AIR FILTER

Fits into Ø 60 mm air intakes.

06701

Scatola / Box 10 / 100

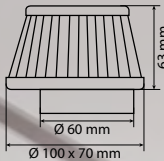

PILOT PERFORMANCE AF-6, FILTRO ARIA CONICO

Montaggio diretto in collettori da Ø 50 mm.

PILOT PERFORMANCE AF-6, CONIC AIR FILTER

Fits into Ø 50 mm air intakes. Exclusive racing look.

06702

Scatola / Box 6 / 24

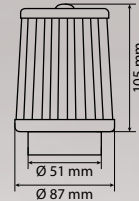

PILOT PERFORMANCE AF-8, FILTRO ARIA CONICO

Montaggio diretto in collettori da Ø 76, 89 e 101 mm.

PILOT PERFORMANCE AF-8, CONIC AIR FILTER

Fits into Ø 76 mm, 89 mm and 101 mm air intakes.

06704

Scatola / Box 4 / 24

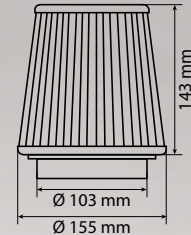

PILOT - PERFORMANCE

PILOT-PERFORMANCE, FILTRI ARIA AD ALTE PRESTAZIONI

Progettati per garantire una portata d'aria maggiore rispetto ai tradizionali filtri in carta ed ottenere una migliore performance del motore. Lavabili e riutilizzabili più volte per una lunga durata e per un risparmio nei costi.

PILOT-PERFORMANCE, HIGH-FLOW AIR FILTERS

Designed to optimize air-flow volume and increase horsepower and acceleration. Washable, reusable for an extreme long life.

Filtri in carta - Standard filters



= 200.000 KM

PERFORMANCE AIR FILTER + Kit Lavaggio Washing kit (COF500+COA200)



= 500.000 KM



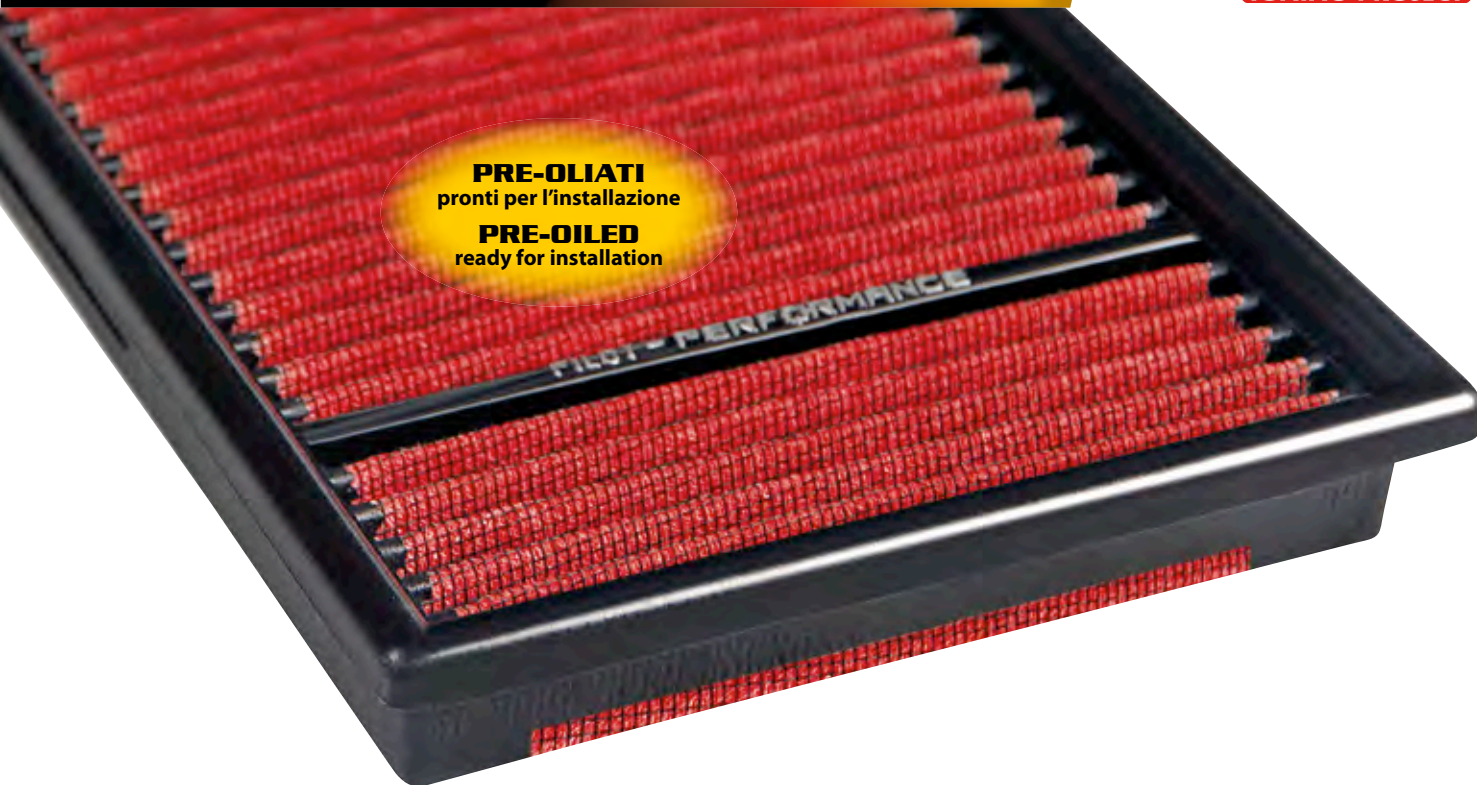

PRE-OLIATI
pronti per l'installazione
PRE-OILED
ready for installation

MATERIALI

I materiali utilizzati per la produzione sono i migliori disponibili sul mercato.

POLIURETANO: leggero, flessibile ed inattaccabile da agenti chimici ed atmosferici.

COTONE: prodotto naturale, traspirante dalle caratteristiche ineguagliabili.

RETE IN ALLUMINIO: anodizzata e trattata con resina epossidica per garantire una efficace resistenza ai vapori del carburante e alla ossidazione dovuta all'umidità dell'aria e alla presenza di polveri di sodio cloruro (sale, comunemente usato in inverno per prevenire la formazione di ghiaccio sulla strada).

TECNOLOGIA "IN-MOULD"

I filtri Pilot-Performance sono prodotti utilizzando una speciale resina in poliuretano, leggera, morbida e flessibile, stampata ed iniettata a caldo. Con questo unico procedimento denominato "IN-MOULD" la superficie filtrante viene "sigillata" all'interno della cornice in poliuretano e tutto il filtro diventa un corpo unico, senza incollaggi, saldature o fessure che potrebbero comprometterne la durata e la performance.

QUALI SONO I VANTAGGI DEI FILTRI IN COTONE PILOT-PERFORMANCE?

- I filtri in cotone utilizzano la stessa tecnologia e gli stessi materiali dei filtri comunemente installati sulle vetture da competizione, formula uno, rally e velocità turismo.
- Questi filtri consentono di limitare al minimo la perdita di pressione del flusso d'aria che attraversa il filtro stesso ed entra nella camera di combustione.
- Più aria entra nel motore, maggiore è l'efficienza della combustione e di conseguenza, anche la potenza e l'accelerazione beneficiano di questo miglioramento.

PERFORMANTE - ECOLOGICO - CONVENIENTE

- A differenza dei filtri in carta, il filtro Pilot-Performance, non necessita di sostituzione e può essere utilizzato per tutta la vita del veicolo.
- Ad intervalli di 20-25.000 Km, il filtro può essere lavato e rigenerato, utilizzando l'apposito KIT di lavaggio (il kit è composto da detergente e olio rigenerante).
- Le migliaia di microscopici filamenti in cotone assorbono l'olio appositamente formulato, trattengono tutte le impurità dell'aria, proteggono il motore ed assicurano sempre il flusso ottimale di aria.

MATERIALS

Manufactured using the best raw materials.

POLYURETHANE: light, flexible, anti-ageing and chemical-proof.

COTTON: unbeatable natural fibre, well-known for its breathing property.

ALUMINIUM MESH: anodized and epoxy coated to guarantee a long lasting resistance to fuel vapours as well to oxidation caused by air humidity and the presence of sodium chloride (known as salt, commonly used in winter to prevent ice on roads).

"IN-MOULD" TECHNOLOGY

All Pilot-Performance filters are manufactured using a special soft and light

polyurethane resin which is hot-injected into the mould.

With this unique manufacturing process called "IN-MOULD", the filtering unit is being "moulded" into the injected resin frame forming a single-body product.

The result of this process is a "state of the art" filter, without any gluing, welding or slots which could compromise the performance and the durability.

WHAT ARE THE ADVANTAGES OF USING PILOT-PERFORMANCE COTTON FILTERS?

- Our filters use same technology and materials as used on the competition vehicles such as formula one, rally and touring race cars.
- These filters reduce the air restrictions, allow more air through the filter, let the engine breath more and perform at its best.
- More air reaches the engine, better is the combustion and consequently more horsepower and acceleration are performed.

HIGHLY PERFORMANT - ENVIRONMENTAL FRIENDLY - CONVENIENT

- One Pilot-Performance filter will last the life of your vehicle. No more air filter replacements are necessary.
- At regular intervals of 20-25.000 Km. the filter can be washed and regenerated by using the specially formulated WASHING KIT (consisting of detergent and regenerating oil).
- Thousands of microscopic cotton threads absorb the specially formulated oil to create a powerful and efficient filtering media that protects motor from harmful contaminants.

FLOW CAPACITY - FILTER MATERIAL TEST

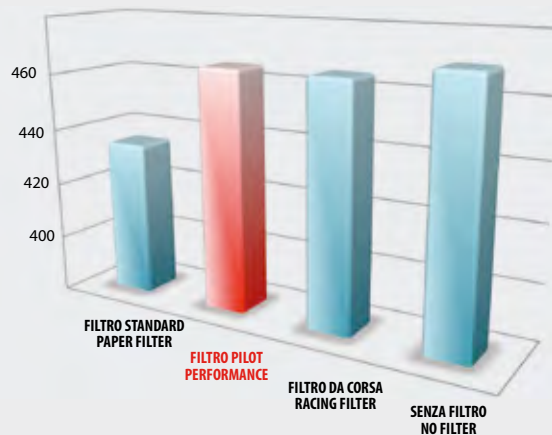

La tabella comparativa si riferisce a filtri nuovi, testati in laboratorio. I dati possono variare in base al modello di filtro ed al veicolo.

This chart is an example of individual filter tested using laboratory equipment in dust-free conditions. Data may vary depending on filter model and vehicle.

Codice Code	Forma Shape	Lungh. Length mm	Largh. Width mm	Altezza Height mm	Ø Int. mm	Ø est. Ø ext. mm
06371	Rettangolare	245	167			
06372	Rettangolare	254	213			
06373	Cilindrica			162	91	125
06374	Rettangolare	244	178			
06375	Cilindrica			243	74	111
06376	Rettangolare	274	184			
06377	Rettangolare	359	184			
06378	Rettangolare	264	149			
06379	Rettangolare	522	178			
06380	Rettangolare	296	233			
06381	Rettangolare	323	134			
06382	Rettangolare	312	212			
06383	Rettangolare	368	134			
06384	Rettangolare	315	190			
06385	Rettangolare	289	139			
06386	Rettangolare	406	172			
06387	Rettangolare	342	133			
06388	Cilindrica			167	85	130
06389	Trapezoidale	530	170/128			
06390	Cilindrica			183	91	161
06391	Rettangolare	203	164			
06392	Rettangolare	234	86			
06393	Rettangolare	244	178			
06394	Rettangolare	377	140			
06395	Rettangolare	292	224			
06396	Cilindrica			250	103	141
06397	Rettangolare	244	178			
06398	Rettangolare	282	168			
06400	Rettangolare	306	111			
06401	Trapezoidale	177	142/90			
06402	Cilindrica			271	68	105
06403	Cilindrica			381	90	140
06404	Rettangolare	355	134			
06405	Rettangolare	308	134			
06406	Rettangolare	186	770			
06407	Rettangolare	299	163			
06408	Rettangolare	290	206			
06409	Rettangolare	271	170			
06410	Rettangolare	319	150			
06411	Rettangolare	217	167			
06412	Trapezoidale	217	210/127			
06413	Rettangolare	375	83			
06414	Rettangolare	317	114			
06415	Rettangolare	335	101			
06416	Rettangolare	287	189			
06417	Trapezoidale	241	241/190			
06418	Rettangolare	386	185			
06419	Rettangolare	374	87			
06420	Rettangolare	213	204			
06421	Cilindrica			170	72	145
06422	Cilindrica			260	95	144
06423	Cilindrica			212	70	157
06424	Rettangolare	198	163			
06425	Rettangolare	239	111			
06426	Trapezoidale	247	190/133			
06427	Rettangolare	355	130			
06428	Rettangolare	266	212			
06429	Rettangolare	320	128			
06430	Rettangolare	273	185			
06431	Rettangolare	370	189			
06432	Trapezoidale	310	143/115			
06433	Rettangolare	254	248			
06435	Trapezoidale	272	251/165			

Kit lavaggio Washing kit



PULITORE FILTRO ARIA
Idoneo per tutti i filtri Pilot Performance

AIR FILTER CLEANER
Suitable for all Pilot Performance air filters

COF500 500 ml

Nebulizzatore / Trigger spray ☑ 12



**LIQUIDO RIGENERANTE
FILTRO ARIA**
Idoneo per tutti i filtri Pilot Performance

**AIR FILTER REGENERATIVE
SOLUTION**
Suitable for all Pilot Performance air filters

COA200 200 ml

Bomboletta / Spray ☑ 24



Modello Model	Motore Engine	Anno Year	Potenza (CV) Power (HP)	No. Filt.	Codice Code
ABARTH					
500 / 500C	1.4 16V Turbo T-Jet	08>	135/140/160/180	1 x	06425
Grande Punto	1.4 Turbo T-Jet	07>	155	1 x	06420
Punto Evo	1.4 Turbo Multiair	09>	163/180	1 x	06420
Stilo	2.4 20V 5 Cyl.	01>10	170	1 x	06409

ALFA ROMEO					
145	1.4 i TS 16V	97>00	103	1 x	06371
145	1.6 i TS 16V	96>00	120	1 x	06371
145	1.8 i 16V	98>00	144	1 x	06371
145	1.8 i TS 16V	96>98	140	1 x	06371
145	1.9 JTD Turbo Diesel	98>00	105	1 x	06371
145	2.0 i 16V	95>00	150/155	1 x	06371
146	1.4 i TS 16V	96>00	103	1 x	06371
146	1.6 i TS 16V	96>00	120	1 x	06371
146	1.8 i TS 16V	96>00	140/144	1 x	06371
146	1.9 JTD	99>00	105	1 x	06371
146	2.0 i 16V	95>00	150/155	1 x	06371
146	2.0 TD	95>00	90	1 x	06371
147	1.6 TS 16V	00>08	105/120	1 x	06405
147	1.9 JTD	03>08	101/115/120/140/150/170	1 x	06407
147	2.0 TS 16V	00>08	150	1 x	06405
147	3.2 V6 GTA	03>08	250	1 x	06396
155	1.6 TS 16V	96>97	120	1 x	06371
155	1.8 TS 16V	95>97	140	1 x	06371
156 / Sportwagon	1.6 TS 16V	97>06	120	1 x	06396
156 / Sportwagon	1.8 TS 16V	97>06	140/144	1 x	06396
156 / Sportwagon	1.9 JTD	97>06	105/110/115/150	1 x	06396
156 / Sportwagon	2.0 JTS 16V	02>06	165/166	1 x	06396
156 / Sportwagon	2.0 TS 16V	97>07	150/155	1 x	06396
156 / Sportwagon	2.0 V6 Turbo S	98>07	205	1 x	06396
156 / Sportwagon	2.4 JTD	97>07	136/140/175/176	1 x	06396
156 / Sportwagon	2.5 V6 24V	97>05	188/190	1 x	06396
156 / Sportwagon	3.0 V6	98>07	220/241/250	1 x	06396
33 II (907)	1.3	90>95	88	1 x	06427
GT	1.8 TS	04>08	140	1 x	06405
GT	1.9 JTD m-jet	04>10	150/170	1 x	06407
GT	2.0 JTS	04>08	165	1 x	06405
GT	3.2 V6	04>08	250	1 x	06396
GTV	1.8 16V	98>03	144	1 x	06396
GTV	2.0 16V	95>03	150	1 x	06396
GTV	2.0 JTS 16V	03>	165	1 x	06396
GTV	2.0 TS 16V	03>	150	1 x	06396
GTV	3.0 V6 24V	95>03	220	1 x	06396
GTV	3.2 V6 24V	03>	240	1 x	06396
GTV (916C)	2.0 V6 TURBO	95>	202	1 x	06371
Mito	1.3 JTDM	10>	84/95	1 x	06427
Mito	1.3 Multijet	09>10	90	1 x	06419
Mito	1.4	08>	68/78/95	1 x	06410
Mito	1.4 MultiAir	10>	105	1 x	06410
Mito	1.4 MultiAir	09>	135	1 x	06420
Mito	1.4 T-Jet	08>	120/155/170	1 x	06420
Mito	1.6 Multijet	08>	120	1 x	06420
Spider	1.8 16V	98>05	144	1 x	06396
Spider	2.0 16V	95>05	150/155/165	1 x	06396
Spider	3.0 V6 24V	95>05	192	1 x	06396

AUDI					
A1 / Sportback	1.2 TFSI	10>	86	1 x	06421
A1 / Sportback	1.4 TFSI	10>	122/140/184	1 x	06421
A1 / Sportback	1.6 TDI / DPF	10>	90/105	1 x	06421
A1 / Sportback	2.0 TDI	11>	143	1 x	06421
A3 / Cabrio / Sportback	1.6	96>00	101/102	1 x	06377
A3 / Cabrio / Sportback	1.6 TDI	09>	90/105	1 x	06387
A3 / Cabrio / Sportback	1.8	96>03	125/150/180	1 x	06377
A3 / Cabrio / Sportback	1.8 TFSI	06>	160	1 x	06387
A3 / Cabrio / Sportback	1.8 Turbo	99>03	210/225	1 x	06377
A3 / Cabrio / Sportback	1.9 TDI	03>	105	1 x	06387

Modello Model	Motore Engine	Anno Year	Potenza (CV) Power (HP)	No. Filt.	Codice Code
A3 / Cabrio / Sportback	1.9 TDI	96>03	90/100/110/115/130	1 x	06377
A3 / Cabrio / Sportback	2.0 TDI	05>08	163	1 x	06387
A3 / Cabrio / Sportback	2.0 TDI	03>	136/140/170	1 x	06387
A3 / Cabrio / Sportback	2.0 TFSI	04>	200/256/265	1 x	06386
A4 / Cabrio / Avant	1.6	95>00	101	1 x	06372
A4 / Cabrio / Avant	1.6	04>08	102	1 x	06428
A4 / Cabrio / Avant	1.8	95>00	125/150/180	1 x	06372
A4 / Cabrio / Avant	1.8 T	00>08	150/163/190	1 x	06428
A4 / Cabrio / Avant	1.8 TFSI	07>	120/160/170	1 x	06429
A4 / Cabrio / Avant	1.9 TDI	00>08	101/116/130	1 x	06428
A4 / Cabrio / Avant	1.9 TDI	95>00	75/90/110/115	1 x	06372
A4 / Cabrio / Avant	2.0	00>08	130/150	1 x	06428
A4 / Cabrio / Avant	2.0 TDI	07>	120/136/140/163/170	1 x	06429
A4 / Cabrio / Avant	2.0 TDI	04>08	126/136/140/170	1 x	06428
A4 / Cabrio / Avant	2.0 TFSI	04>08	170/200/220	1 x	06428
A4 / Cabrio / Avant	2.0 TFSI	08>	180/211	1 x	06429
A4 / Cabrio / Avant	2.4	97>00	163/165	1 x	06372
A4 / Cabrio / Avant	2.4 V6	01>04	163/170	1 x	06428
A4 / Cabrio / Avant	2.5 TDI V6	97>00	150	1 x	06372
A4 / Cabrio / Avant	2.5 TDI V6	00>06	155/163/180	1 x	06428
A4 / Cabrio / Avant	2.6 E V6	95>00	150	1 x	06372
A4 / Cabrio / Avant	2.7 TDI	05>08	163/180	1 x	06428
A4 / Cabrio / Avant	2.8 E V6 / Quattro	95>00	174/193	1 x	06372
A4 / Cabrio / Avant	3.0 TDI	04>08	204/233	1 x	06428
A4 / Cabrio / Avant	3.0 V6	00>06	218/220	1 x	06428
A4 / Cabrio / Avant	3.2 FSI	05>07	256	1 x	06428
A4 / Cabrio / Avant	RS4	00>01	480	1 x	06372
A4 / Cabrio / Avant	S4 / RS4	97>02	265/380	1 x	06372
A4 / Cabrio / Avant	S4 / RS4	03>08	344/420	1 x	06428
A5 / Cabrio / Sportback	1.8 TFSI	07>	160/170	1 x	06429
A5 / Cabrio / Sportback	2.0 TDI	08>	143/170	1 x	06429
A5 / Cabrio / Sportback	2.0 TFSI	08>	180/211	1 x	06429
A6 / Avant / Allroad	1.8	97>05	125/150/180	1 x	06372
A6 / Avant / Allroad	1.9 TDI	97>05	110/115/130	1 x	06372
A6 / Avant / Allroad	2.0	01>05	130	1 x	06372
A6 / Avant / Allroad	2.0 TDI	04>11	121/136/140/163/170	1 x	06388
A6 / Avant / Allroad	2.0 TFSI	05>11	170	1 x	06388
A6 / Avant / Allroad	2.4	97>05	136/156/163/165/170	1 x	06372
A6 / Avant / Allroad	2.4	04>10	177	1 x	06390
A6 / Avant / Allroad	2.5 TDI V6	97>05	150/155/163/180	1 x	06372
A6 / Avant / Allroad	2.7 T V6	97>05	230/250	1 x	06372
A6 / Avant / Allroad	2.7 TDI	04>11	163/180/190	1 x	06390
A6 / Avant / Allroad	2.8	97>05	180/190/193	1 x	06372
A6 / Avant / Allroad	2.8 FSI	06>11	190/210/220	1 x	06390
A6 / Avant / Allroad	3.0	97>04	220	1 x	06372
A6 / Avant / Allroad	3.0	04>11	218/290/299	1 x	06390
A6 / Avant / Allroad	3.0 TDI	04>11	240	1 x	06390
A6 / Avant / Allroad	3.2 FSI	04>09	255	1 x	06390
A6 / Avant / Allroad	3.7	99>05	260	1 x	06372
A6 / Avant / Allroad	4.2	98>05	299/300	1 x	06372
A6 / Avant / Allroad	4.2 FSI	06>11	255	1 x	06390
A6 / Avant / Allroad	S6 / RS6	98>05	340/450	1 x	06372
A6 / Avant / Allroad	S6 / RS6	04>11	335/350	1 x	06390
Q3	2.0 TDI	11>	140/177	1 x	06387
Q3	2.0 TFSI	11>	170/211	1 x	06387
Q5	2.0 TDI	08>	136/143/170	1 x	06429
Q5	2.0 TFSI	08>	180/211/245	1 x	06429
Q7	3.0 TFSI	10>	272/333	1 x	06418
Q7	3.0 V6 TDI	06>	211/224/233/240/245	1 x	06418
Q7	3.6 FSI	06>	280	1 x	06418
Q7	4.2 V8 FSI	06>	349	2 x	06418
Q7	4.2 V8 TDI	07>	326/340	2 x	06418
Q7	6.0 V12 TDI	08>	500	2 x	06418
TT / Roadster	1.8 T	02>06	150/163/180/190/224/240	1 x	06377
TT / Roadster	1.8 TFSI	08>	160	1 x	06387
TT / Roadster	2.0 TDI	08>	170	1 x	06387

Modello Model	Motore Engine	Anno Year	Potenza (CV) Power (HP)	No. Filt.	Codice Code
TT / Roadster	2.0 TFSI	08>	211/265	1 x	06387
TT / Roadster	2.0 TFSI (motore BWA/BPY)	06>	200	1 x	06386
TT / Roadster	2.0 TFSI (motore CCZA/CCTA)	06>	200	1 x	06387
TT / Roadster	3.2 VR6	03>06	250	1 x	06377

BMW					
Serie 1 (E87)	118 d	04>07	122	1 x	06403
Serie 1 (E87)	120 d	04>07	163	1 x	06403
Serie 3 (E36)	320 i	90>99	150	1 x	06393
Serie 3 (E36)	323 i	95>05	170	1 x	06393
Serie 3 (E36)	325 i	95>05	192	1 x	06393
Serie 3 (E36)	328 i	95>99	193	1 x	06393
Serie 3 (E36)	2.8 i M3	92>00	286/295/321	1 x	06393
Serie 3 (E36)	3.0 i M3	92>00	286/295/321	1 x	06393
Serie 3 (E36)	3.2 i M3	92>00	286/295/321	1 x	06393
Serie 3 (E46)	316 i	98>02	105	1 x	06393
Serie 3 (E46)	318 i	98>02	118	1 x	06393
Serie 3 (E46)	320 i	98>07	150/170	1 x	06393
Serie 3 (E46)	323 i	98>07	170/192	1 x	06393
Serie 3 (E46)	328 i	98>00	193	1 x	06393
Serie 3 (E46)	330 i	00>07	231	1 x	06393
Serie 3 (E46)	318 d	01>05	116	1 x	06403
Serie 3 (E46)	320 d	98>05	136/150	1 x	06403
Serie 3 (E46)	3.2 M3	00>07	333/343	1 x	06393
Serie 3 / Touring (E90)	318 d	05>07	122	1 x	06403
Serie 3 / Touring (E90)	320 d	05>07	163	1 x	06403
Serie 5 (E34)	530 i	92>96	218	1 x	06372
Serie 5 (E34)	540 i	92>96	286	1 x	06372
Serie 5 (E39)	520 i	96>99	150	1 x	06393
Serie 5 (E39)	523 i	95>03	170	1 x	06393
Serie 5 (E39)	520 i	00>03	170	1 x	06393
Serie 5 (E39)	525 i	95>03	192	1 x	06393
Serie 5 (E39)	528 i	95>03	193	1 x	06393
Serie 5 (E39)	530 i	00>03	231	1 x	06393
Serie 5 (E39)	520 d	00>03	136	1 x	06403
Serie 5 (E39)	535 d	98>03	245	1 x	06372
Serie 5 (E39)	535 i	96>98	235	1 x	06372
Serie 5 (E39)	540 i	96>98	286	1 x	06372
Serie 5 (E39)	540 i	98>03	286	1 x	06372
Serie 5 (E39)	M5	98>03	400	2 x	06372
Serie 5 / Touring (E60)	520 d	05>07	163	1 x	06403
Serie 5 / Touring (F10)	520 i	11>	184	1 x	06435
Serie 5 / Touring (F10)	528 i	11>	245	1 x	06435
Serie 7 (E32) 730 i	730 i	92>94	218	1 x	06372
Serie 7 (E32) 740 i	740 i	92>94	286	1 x	06372
Serie 7 (E38)	728 i	96>01	193	1 x	06393
Serie 7 (E38)	730 i	94>96	218	1 x	06372
Serie 7 (E38)	735 i	94>97	235	1 x	06372
Serie 7 (E38)	735 i	98>01	237	1 x	06372
Serie 7 (E38)	740 i	94>01	286	1 x	06372
Serie 8 (E31)	840 i	92>96	286	1 x	06372
X1 (E84)	sDrive20i	11>	184	1 x	06435
X1 (E84)	xDrive28i	11>	245	1 x	06435
X3 (E83)	2.0	04>07	150	1 x	06403
X3 (E83)	2.5	04>06	192	1 x	06393
X3 (E83)	3.0	03>06	231	1 x	06393
X5 (E53)	4.4 i	00>03	286	1 x	06372
X5 (E53)	4.4 i	04>06	320	1 x	06372
X5 (E53)	4.6 is	01>03	340	1 x	06372
X5 (E53)	4.8 is	04>06	360	1 x	06372
Z3 Coupe / Roadster	2.8 i	97>00	193	1 x	06393
Z3 Coupe / Roadster	3.0 i	00>03	231	1 x	06393
Z3 Coupe / Roadster	3.2 i	97>03	321	1 x	06393
Z3 Coupe / Roadster	2.0 i	99>03	150	1 x	06393
Z3 Coupe / Roadster	2.2 i	00>06	170	1 x	06393
Z3 Coupe / Roadster	2.5 i	99>02	170/177/192	1 x	06393
Z3 Coupe / Roadster	3.0 i	02>05	231	1 x	06393
Z4 Roadster (E89)	sDrive20i	11>	184	1 x	06435

Modello Model	Motore Engine	Anno Year	Potenza (CV) Power (HP)	No. Filt.	Codice Code
Z4 Roadster (E89)	sDrive23i	09>11	204	1 x	06435
Z4 Roadster (E89)	sDrive28i	11>	245	1 x	06435
Z4 Roadster (E89)	sDrive30i	09>11	258	1 x	06435
Z8 (E52)	5.0 i	99>03	400	2 x	06372

CHEVROLET

Cruze	1.6	09>	113	1 x	06433
Cruze	1.8	09>	141	1 x	06433
Orlando	1.8	11>	141	1 x	06433

CITROEN

AX	1.1 i	86>97	60	1 x	06373
AX	1.3	91>96	94/100	1 x	06375
AX	1.4	91>97	75/90	1 x	06373
Berlingo	1.1	02>08	60	1 x	06415
Berlingo	1.1	96>02	60	1 x	06373
Berlingo	1.4	02>08	65/72/75	1 x	06415
Berlingo	1.6 16v	02>08	109	1 x	06415
Berlingo	1.6 HDI	08>	75/90	1 x	06414
Berlingo	1.6 HDI	05>08	75/90/110	1 x	06414
C1	1.4 HDI	05>	54	1 x	06385
C15 / SW	1.4	87>96	67/75	1 x	06373
C2	1.1	02>10	60	1 x	06415
C2	1.4	02>10	73/90	1 x	06415
C2	1.4 HDI	03>	68	1 x	06385
C2	1.6	02>10	109/122	1 x	06415
C2	1.6 HDI	05>	109	1 x	06414
C3	1.1	10>	60	1 x	06415
C3	1.1 8V	02>09	60	1 x	06415
C3	1.4	02>09	73/88	1 x	06415
C3	1.4 HDI	02>09	68	1 x	06385
C3	1.4 HDI	02>09	90	1 x	06414
C3	1.6 16V	02>09	110	1 x	06415
C3	1.6 HDI 16V	05>09	90/109	1 x	06414
C3 Pluriel	1.4	03>10	75	1 x	06415
C3 Pluriel	1.6 16V	03>10	110	1 x	06415
C4	1.6 16V HDI	04>10	90/109	1 x	06414
C4	2.0 16V	05>10	136/140/177	1 x	06371
C4	2.0 16V HDI (cambio automatico)	04>	136	1 x	06398
C4	2.0 16V HDI (cambio manuale)	05>10	136/140	1 x	06371
C4 Grand Picasso	1.6 16V HDI	07>	109	1 x	06414
C4 Grand Picasso	2.0 16V HDI	07>13	136/150/165	1 x	06398
C4 Picasso	1.6 16V HDI FAP	07>	109	1 x	06414
C4 Picasso	2.0 16V HDI	07>13	136/150/165	1 x	06398
C5 / SW	2.0 HDI	08>	136/140/163	1 x	06410
C-Crosser	2.2 HDI	08>	156	1 x	06430
C-Crosser	2.4 16V	08>	170	1 x	06430
Nemo	1.3 HDI 75	10>	75	1 x	06427
Nemo	1.4 D	09>	68	1 x	06385
Saxo	1.1 i	96>03	60	1 x	06373
Saxo	1.6	96>04	98/101/118	1 x	06400
Saxo	1.6 i	96>04	90/120	1 x	06373
Xantia / SW	2.0 i 16V	93>95	150/152	1 x	06375
Xsara / Coupe / SW	1.4 HDI	03>05	68	1 x	06385
Xsara / Coupe / SW	1.8 TD	97>00	90	1 x	06375
Xsara / Coupe / SW	2.0 i 16v	98>00	132	1 x	06375
Xsara Picasso	1.6 16V HDI	04>	90/109	1 x	06414
ZX	1.1	91>97	54/60	1 x	06373
ZX	1.4 i	91>97	75	1 x	06373
ZX	1.9	91>97	120/126	1 x	06375
ZX	1.9 DT	92>97	88/92	1 x	06375
ZX	1.9 TD	92>97	90	1 x	06375
ZX	2.0	96>97	166	1 x	06375
ZX	2.0 i 16V	92>97	150/152/163	1 x	06375

DACIA

Duster	1.5 dCi	10>	86	1 x	06413
Duster	1.6 16V	10>	110	1 x	06401

Modello Model	Motore Engine	Anno Year	Potenza (CV) Power (HP)	No. Filt.	Codice Code
Logan	1.5 dCi	05>	65/68	1 x	06413
Logan	1.6 16V	06>	105	1 x	06401
Sandero	1.5 dCi	05>	68/86	1 x	06413

DODGE					
Viper	8.0	92>02	450	2 x	06405

FIAT					
500 / 500C	1.3 16V Multijet	07>	75	1 x	06419
500 / 500C	1.3 16V Multijet D	09>	95	1 x	06427
500 / 500C	1.4 16V	07>	100	1 x	06410
500L	1.3 16V Multijet D	12>	84	1 x	06427
500L	1.4	12>	95	1 x	06410
Barchetta	1.8 16V	94>05	130	1 x	06396
Brava	1.2 16V	98>03	80/82	1 x	06371
Brava	1.4 12V	95>03	75/80	1 x	06371
Brava	1.6 16V	95>03	90/103	1 x	06371
Brava	1.8 16V GT	95>03	113	1 x	06371
Brava	1.9 D	95>03	65	1 x	06371
Brava	1.9 JTD	98>03	100/105	1 x	06371
Brava	1.9 TD	96>03	75/100	1 x	06371
Bravo	1.2 16V	98>01	80/82	1 x	06371
Bravo	1.4 12V	95>01	75/80	1 x	06371
Bravo	1.4 16V	07>	90	1 x	06410
Bravo	1.4 T-Jet	07>	120/140/150	1 x	06422
Bravo	1.6 16V	95>01	90/103	1 x	06371
Bravo	1.6 Multijet D	07>	105/115/120	1 x	06422
Bravo	1.8 16V GT	95>01	113	1 x	06371
Bravo	1.9 D	95>01	65	1 x	06371
Bravo	1.9 JTD	96>01	100/105	1 x	06371
Bravo	1.9 Multijet D	07>10	120/150	1 x	06409
Bravo	1.9 TD	96>01	75	1 x	06371
Bravo	2.0 20V HGT	95>01	147/155	1 x	06371
Bravo	2.0 Multijet D	08>	163/165	1 x	06422
Cinquecento	1.1 i	94>98	55	1 x	06392
Coupe	1.8 16V	93>98	130	1 x	06397
Coupe	2.0 16V	93>00	140/147/154/ 190/220	1 x	06397
Doblo	1.3 Multijet	05>09	84	1 x	06419
Doblo	1.3 Multijet	10>	90	1 x	06419
Doblo	1.4	10>	95/120	1 x	06410
Doblo	1.6 Multijet	10>	90/105	1 x	06420
Doblo	2.0 Multijet	10>	135	1 x	06420
Fiorino	1.3 Multijet	08>	75	1 x	06419
Fiorino	1.3 Multijet D	09>	95	1 x	06427
Grande Punto	1.3 16V Multijet	05>	75/69/84/90	1 x	06419
Grande Punto	1.4 16V	06>	95	1 x	06410
Grande Punto	1.4 Turbo T-Jet	07>12	120	1 x	06420
Grande Punto	1.6 Multijet	08>12	120	1 x	06420
Grande Punto	1.9 16V Multijet	05>12	116/120/130	1 x	06420
Grande Punto Van	1.3 Multijet D	08>	75	1 x	06427
Idea	1.2 16V	04>	80	1 x	06410
Idea	1.3 JTD	04>12	70	1 x	06419
Idea	1.3 Multijet D	09>	95	1 x	06427
Idea	1.4	04>	77/95	1 x	06410
Idea	1.9 JTD	04>12	101	1 x	06402
Marea / SW	1.2 16V	98>03	82	1 x	06371
Marea / SW	1.4 12V	96>03	80	1 x	06371
Marea / SW	1.6 16 V	97>03	103	1 x	06371
Marea / SW	1.8 16V	97>03	113	1 x	06371
Marea / SW	1.9 JTD	96>03	100/105/110	1 x	06371
Marea / SW	2.0 20V	96>03	147/150/154	1 x	06371
Marea / SW	2.4 JTD	96>03	124/130	1 x	06371
Panda	1.3 Mjt	12>	75	1 x	06427
Panda	1.3 Multijet	03>11	70/75	1 x	06419
Panda	1.4 16V	06>11	100	1 x	06410
Punto	1.1	94>99	55	1 x	06392
Punto	1.2	94>99	60	1 x	06392
Punto	1.2	94>99	85	1 x	06394
Punto	1.2 16V	99>10	80	1 x	06381

Modello Model	Motore Engine	Anno Year	Potenza (CV) Power (HP)	No. Filt.	Codice Code
Punto	1.3 16V Multijet	12>	84/75/95	1 x	06419
Punto	1.3 JTD 16V	03>05	70	1 x	06419
Punto	1.4 16V	99>10	95	1 x	06410
Punto	1.4 Multiair	12>	105	1 x	06410
Punto	1.4 Turbo	94>99	131/133	1 x	06394
Punto	1.4 Turbo Multiair	12>	135	1 x	06420
Punto	1.6	94>99	88	1 x	06394
Punto	1.8	99>10	130	1 x	06402
Punto	1.9 D	99>10	60	1 x	06402
Punto	1.9 JTD	99>10	80/86/101	1 x	06402
Punto Evo	1.3 Multijet (No DPF)	09>12	75/90/95	1 x	06419
Punto Evo	1.3 Multijet DPF	10>12	84	1 x	06427
Punto Evo	1.4 MultiAir	09>12	105	1 x	06410
Punto Evo	1.4 MultiAir Turbo	09>12	135	1 x	06420
Punto Evo	1.6 Multijet DPF	09>12	120	1 x	06420
Qubo	1.3 Multijet	08>	75	1 x	06419
Qubo	1.3 Multijet D	09>	95	1 x	06427
Seicento	1.1	98>01	55	1 x	06392
Stilo	1.2 16V	01>10	80	1 x	06410
Stilo	1.4 16V	04>10	90/95	1 x	06410
Stilo	1.8 16V	01>10	133	1 x	06409
Stilo	1.9 JTD	01>10	80/115/140	1 x	06409
Stilo	1.9 Multijet D	05>10	100/120/150	1 x	06409
Stilo	2.4 20V	01>10	170	1 x	06409
Tipo	1.4	87>95	71/78	1 x	06392
Tipo	1.6	88>93	78/83/90	1 x	06392
Uno	1.4	89>93	71/72	1 x	06392

FORD					
B-Max	1.0 Ecoboost	12>	100/120	1 x	06424
B-Max	1.4	12>	90	1 x	06424
B-Max	1.5 TDCI	12>	75	1 x	06424
B-Max	1.6 TDCI	12>	95	1 x	06424
B-Max	1.6 Ti	12>	105	1 x	06424
C-Max	1.6 TDCI	07>10	90/110	1 x	06423
C-Max	1.6 TDCI	11>	95/115	1 x	06423
C-Max	1.6i	07>10	100	1 x	06423
C-Max	1.6i	10>	106/125	1 x	06423
C-Max	1.6i ECOBOOST	11>	150/182	1 x	06423
C-Max	1.8	07>10	125	1 x	06423
C-Max	1.8 TDCI	07>10	115	1 x	06423
C-Max	2.0 TDCI	07>10	110/136	1 x	06423
C-Max	2.0 TDCI	11>	115/140/163	1 x	06423
C-Max	2.0i	07>10	145	1 x	06423
Fiesta	1.2 16V	02>08	70/75	1 x	06411
Fiesta	1.3	02>08	60/70	1 x	06411
Fiesta	1.4 16V	02>08	80	1 x	06411
Fiesta	1.4 TDCI	02>08	68	1 x	06385
Fiesta	1.4 TDCI	10>	70	1 x	06385
Fiesta	1.6 16V	02>08	100	1 x	06411
Fiesta VI	1.2	08>	60/82	1 x	06424
Fiesta VI	1.4 16V	09>	97	1 x	06424
Fiesta VI	1.6 TDCI	09>	75/90/95	1 x	06424
Fiesta VI	1.6 Ti	09>	120/134	1 x	06424
Focus / Cabrio / SW	1.4 16V	98>04	75	1 x	06378
Focus / Cabrio / SW	1.4i	07>11	80	1 x	06423
Focus / Cabrio / SW	1.6	04>07	100/115	1 x	06416
Focus / Cabrio / SW	1.6 16V	98>04	100	1 x	06378
Focus / Cabrio / SW	1.6 LPG	09>11	115	1 x	06423
Focus / Cabrio / SW	1.6 TDCI	04>07	110	1 x	06409
Focus / Cabrio / SW	1.6 TDCI	07>11	90/110	1 x	06423
Focus / Cabrio / SW	1.6 Ti	07>11	115	1 x	06423
Focus / Cabrio / SW	1.6i	07>11	100	1 x	06423
Focus / Cabrio / SW	1.8	07>11	125	1 x	06423
Focus / Cabrio / SW	1.8 16V	98>04	115	1 x	06378
Focus / Cabrio / SW	1.8 TDCI	07>11	115	1 x	06423
Focus / Cabrio / SW	1.8 TDCI	98>04	75/90/100/115	1 x	06378
Focus / Cabrio / SW	1.8i	04>07	120/125	1 x	06416
Focus / Cabrio / SW	2.0 16V	98>04	131	1 x	06378

Modello Model	Motore Engine	Anno Year	Potenza (CV) Power (HP)	No. Filtr.	Codice Code
Focus / Cabrio / SW	2.0 LPG	08>11	145	1 x	06423
Focus / Cabrio / SW	2.0 TDCI	07>11	110/133/136	1 x	06423
Focus / Cabrio / SW	2.0i	04>07	145	1 x	06416
Focus / Cabrio / SW	2.0i	07>11	145	1 x	06423
Focus / Cabrio / SW	2.5T RS	09>	305	1 x	06423
Focus / SW	1.0 EcoBoost	12>	100/125	1 x	06423
Focus / SW	1.6 EcoBoost	11>	150/182	1 x	06423
Focus / SW	1.6 TDCI	11>	95/115	1 x	06423
Focus / SW	1.6 Ti (Flexifuel)	11>	105/120/125	1 x	06423
Focus / SW	2.0 ST	11>	250	1 x	06423
Focus / SW	2.0 TDCI	11>	115/140/163	1 x	06423
Focus C-Max	1.6	03>07	100/115	1 x	06416
Focus C-Max	1.6 TDCI	03>07	90/110	1 x	06409
Focus C-Max	1.8i	03>07	120/125	1 x	06416
Focus C-Max	2.0i	04>07	145	1 x	06416
Fusion	1.2	02>	75	1 x	06411
Fusion	1.4 16V	02>	80	1 x	06411
Fusion	1.4 TDCI	02>12	68	1 x	06385
Fusion	1.6 16V	02>	100	1 x	06411
Galaxy	1.9 TDI	96>06	90/110/115	1 x	06382
Galaxy	2.0	95>00	115	1 x	06382
Galaxy	2.3 16V	96>00	145	1 x	06382
Galaxy	2.8 V6	96>00	174/204	1 x	06382
Ka	1.3 TDCI	09>	75	1 x	06419
Kuga	2.0 TDCI 4x4	08>	136/140/163	1 x	06423
Streetka	1.6 16V	03>05	95	1 x	06372
Tourneo Connect	1.8	02>08		1 x	06378
Tourneo Connect	1.8 D	02>08		1 x	06378
Transit Connect	1.8	03>08		1 x	06378
Transit Connect	1.8 D	02>08		1 x	06378

LANCIA					
Dedra / SW	1.6 16V	96>99	103	1 x	06397
Dedra / SW	1.6 ie	89>94	78/90	1 x	06392
Dedra / SW	1.8 ie	94>99	101/113/131	1 x	06397
Dedra / SW	2.0 ie	89>99	139/196/211	1 x	06397
Delta	1.4 B-Fuel	11>	120	1 x	06422
Delta	1.4 Multi-Air	10>	140	1 x	06422
Delta	1.4 T-Jet	08>	120/150	1 x	06422
Delta	1.6 ie	96>99	90	1 x	06392
Delta	1.6 ie	96>99	103	1 x	06397
Delta	1.6 Multijet D	08>	105/116/120	1 x	06422
Delta	1.8 ie	94>99	90/103/113/131	1 x	06397
Delta	1.8 T-Jet	09>	200	1 x	06422
Delta	1.9 Multijet D	09>	190	1 x	06422
Delta	2.0 ie	93>99	139/187/193	1 x	06397
Delta	2.0 Multijet D	08>	165	1 x	06422
K / SW	2.0 i	94>01	146/155/220	1 x	06396
K / SW	2.4 i	94>01	175	1 x	06396
K / SW	2.4 JTD	98>01	136	1 x	06396
K / SW	2.4 TDS	94>01	124	1 x	06396
K / SW	3.0 i	94>01	204	1 x	06396
Lybra / SW	1.6	99>05	103	1 x	06396
Lybra / SW	1.8	99>05	131	1 x	06396
Lybra / SW	1.9 JTD	99>05	105/110/116	1 x	06396
Lybra / SW	2.0	99>05	150/154	1 x	06396
Lybra / SW	2.4 JTD	99>05	134/140/150	1 x	06396
Musa	1.3 Multijet	04>	70/90	1 x	06419
Musa	1.3 Multijet D	09>	95	1 x	06427
Musa	1.4	04>	90/95	1 x	06410
Musa	1.6 Multijet D	08>	116/120	1 x	06402
Musa	1.9 Multijet D	04>	101	1 x	06402
Thesis	2.0 Turbo 20V	02>	185	1 x	06396
Thesis	2.4 20V	02>	170	1 x	06396
Thesis	2.4 JTD	02>	150/175	1 x	06396
Thesis	2.4 Multijet	06>	185	1 x	06396
Thesis	3.0 V6	02>	215	1 x	06396
Thesis	3.2 V6	03>	230	1 x	06396
Y	1.1	95>03	54	1 x	06392
Y	1.2	96>99	60	1 x	06392

Modello Model	Motore Engine	Anno Year	Potenza (CV) Power (HP)	No. Filtr.	Codice Code
Y	1.2 16V	00>03	80	1 x	06381
Y	1.2 16V	97>03	86	1 x	06394
Ypsilon	1.2 16V	03>10	80	1 x	06410
Ypsilon	1.3 JTD	03>11	70	1 x	06419
Ypsilon	1.3 Multijet	06>11	75/90/105	1 x	06419
Ypsilon	1.4	05>10	78	1 x	06410
Ypsilon II	1.3 Multijet	11>	95	1 x	06427

LAND ROVER

Discovery	2.7 Td V6	04>07	190	1 x	06395
Discovery	3.0 SD V6	09>	246	1 x	06395
Discovery	3.0 TD V6	09>	211	1 x	06395
Discovery	4.0 V6	06>		1 x	06395
Discovery	4.4 V8	04>06		1 x	06395
Freelander	2.0 TD4	01>06	109/112	1 x	06403
Range Rover	3.6 TD V8	06>10	272	1 x	06418
Range Rover	4.2 V8	05>09	396	1 x	06395
Range Rover	4.4 V8	05>09	306	1 x	06418
Range Rover Sport	2.7 TDVM	05>	190	1 x	06395
Range Rover Sport	3.0 TD	09>	211/245/272	1 x	06395
Range Rover Sport	4.2 V8	05>	390	1 x	06395
Range Rover Sport	4.4 V8	06>	299	1 x	06418

MAZDA

2	1.2 16V	03>06	75	1 x	06411
2	1.3	03>06		1 x	06411
2	1.4 16V	03>06	80	1 x	06411
2	1.4 MRZ-CD	08>	68	1 x	06385
2	1.4 TD	03>07	68	1 x	06385
2	1.5	03>06		1 x	06411
2	1.6 16V	03>06	101	1 x	06411
2	1.6 MZ-CD	08>	90	1 x	06424
3	1.6 Di Turbo	04>09	109	1 x	06409
3	1.6 MZR-CD	09>	109/116	1 x	06423
3	2.0	03>09	143/150	1 x	06376
3	2.0	09>13	150/151	1 x	06376
3	2.2	09>13	150/185	1 x	06376
3	2.3	06>09	260	1 x	06376
5	1.6 D	10>	HP:	1 x	06423
5	1.8	05>10	116	1 x	06376
5	2.0	05>10	146	1 x	06376
5	2.0 CD	05>10	110/143	1 x	06376

MERCEDES

CL (C215)	500	99>06	306	2 x	06404
CL (C215)	55 AMG	00>06	360/500	2 x	06404
CL (C216)	500	06>10	388	2 x	06404
CL (C216)	550	10>	435	2 x	06381
CL (C216)	500 Blue Effic.	10>	435	2 x	06381
CL (C216)	63 AMG	10>	544/571	2 x	06381
Classe C / SW (W202/S202)	180	93>00	122	1 x	06395
Classe C / SW (W202/S202)	200	93>00	136	1 x	06395
Classe C / SW (W202/S202)	220	93>96	150	1 x	06395
Classe C / SW (W202/S202)	230	96>98	150	1 x	06395
Classe C / SW (W202/S202)	240	97>00	170	1 x	06395
Classe C / SW (W202/S202)	280	93>00	193/197	1 x	06395
Classe C / SW (W202/S202)	200 CDI	98>00	102	1 x	06395
Classe C / SW (W202/S202)	200 Diesel	93>98	75/88	1 x	06395
Classe C / SW (W202/S202)	200 Kompressor	95>00	180/192	1 x	06395
Classe C / SW (W202/S202)	220 CDI	98>00	125	1 x	06395
Classe C / SW (W202/S202)	220 Diesel	93>99	95	1 x	06395
Classe C / SW (W202/S202)	230 Kompressor	95>00	193	1 x	06395
Classe C / SW (W202/S202)	250 Diesel	93>96	113	1 x	06395
Classe C / SW (W202/S202)	250 Turbodiesel	95>00	150	1 x	06395
Classe C / SW (W202/S202)	36 AMG	93>97	280	1 x	06395
Classe C / SW (W203)	240	00>05	170	2 x	06404
Classe C / SW (W203)	280	05>07	231	2 x	06404
Classe C / SW (W203)	320	00>05	218	2 x	06404
Classe C / SW (W203)	350	05>07	272	2 x	06404
Classe C / SW (W203)	230 Kompressor	05>07	204	2 x	06404

Modello Model	Motore Engine	Anno Year	Potenza (CV) Power (HP)	No. Filt.	Codice Code
Classe C / SW (W203)	55 AMG	04>07	367	2 x	06404
Classe C / SW (W204)	230	07>09	204	2 x	06404
Classe C / SW (W204)	280	07>09	231	2 x	06404
Classe C / SW (W204)	300	07>11	231	2 x	06404
Classe C / SW (W204)	350	07>11	272	2 x	06404
Classe C / SW (W204)	180 CGI Blue Effic.	09>	156	1 x	06432
Classe C / SW (W204)	200 CGI Blue Effic.	09>	184	1 x	06432
Classe C / SW (W204)	250 CGI Blue Effic.	09>	204	1 x	06432
Classe C / SW (W204)	350 CGI Blue Effic.	08>11	292	2 x	06404
Classe C Coupe (C204)	180 CGI Blue Effic.	11>	156	1 x	06432
Classe C Coupe (C204)	200 CGI Blue Effic.	11>	184/204	1 x	06432
Classe C Sp.Coupe (CL203)	230	05>11	204	2 x	06404
Classe C Sp.Coupe (CL203)	320	02>05	218	2 x	06404
Classe C Sp.Coupe (CL203)	350	05>08	272	2 x	06404
Classe E / SW (W210/S210)	430	99>02	279	1 x	06384
Classe E / SW (W210/S210)	240 V6	00>02	170	1 x	06384
Classe E / SW (W210/S210)	280 V6	97>02	204	1 x	06384
Classe E / SW (W210/S210)	320 V6	99>02	224	1 x	06384
Classe E / SW (W211)	230	07>08	204	2 x	06404
Classe E / SW (W211)	240	02>05	177	2 x	06404
Classe E / SW (W211)	280	05>09	231	2 x	06404
Classe E / SW (W211)	320	02>05	224	2 x	06404
Classe E / SW (W211)	350	05>09	272	2 x	06404
Classe E / SW (W211)	500	02>09	306/388	2 x	06404
Classe E / SW (W211)	350 CGI	07>08	292	2 x	06404
Classe E / SW (W211)	55 AMG	03>06	476	2 x	06404
Classe E / SW (W212)	350	09>11	272/292	2 x	06404
Classe E / SW (W212)	500	09>11	388	2 x	06404
Classe E / SW (W212)	550	11>	408	2 x	06381
Classe E / SW (W212)	200 CGI Blue Effic.	09>	184	1 x	06432
Classe E / SW (W212)	250 CGI	09>	204	1 x	06432
Classe E / SW (W212)	300 CDI	11>	231	2 x	06404
Classe E / SW (W212)	500 Blue Effic.	11>	408	2 x	06381
Classe E / SW (W212)	63 AMG	11>	557	2 x	06381
Classe E Cabrio (A207)	500	10>	388	2 x	06404
Classe E Cabrio (A207)	200 CGI Blue Effic.	10>	184	1 x	06432
Classe E Cabrio (A207)	250 CGI	10>	204	1 x	06432
Classe E Cabrio (A207)	350 CGI Blue Effic.	10>	292	2 x	06404
Classe E Cabrio (A207)	500 Blue Effic.	11>	408	2 x	06381
Classe E Coupe (C207)	500	09>	388	2 x	06404
Classe E Coupe (C207)	200 CGI Blue Effic.	10>	184	1 x	06432
Classe E Coupe (C207)	250 CGI	09>	204	1 x	06432
Classe E Coupe (C207)	350 CGI Blue Effic.	09>	292	2 x	06404
Classe E Coupe (C207)	500 Blue Effic.	11>	408	2 x	06381
Classe G (W463)	320	97>05	210/215	2 x	06404
Classe G (W463)	500	99>07	296	2 x	06404
Classe G (W463)	500	07>	387/388	2 x	06404
Classe G (W463)	55 AMG	07>	507	2 x	06404
Classe G (W463)	55 AMG	02>07	354/476/500	2 x	06404
Classe G (W463)	63 AMG	10>	544	2 x	06381
Classe GL (X164)	450	06>	340	2 x	06404
Classe GL (X164)	500	06>	388	2 x	06404
Classe GL (X164)	550	08>	388	2 x	06404
Classe GLK (X204)	280 4-matic	08>09	231	2 x	06404
Classe GLK (X204)	300 4-matic	09>	231	2 x	06404
Classe GLK (X204)	350 4-matic	08>	272	2 x	06404
Classe M (W163)	230	97>00	150	1 x	06395
Classe M (W163)	320	97>05	214	1 x	06395
Classe M (W163)	340	96>01	272	1 x	06395
Classe M (W163)	350	02>05	235	1 x	06395
Classe M (W163)	500	01>05	292	1 x	06395
Classe M (W163)	400 CDI	01>05	250	1 x	06395
Classe M (W163)	55 AMG	99>05	347	1 x	06395
Classe M (W164)	350	05>11	272	2 x	06404
Classe M (W164)	500	05>11	306/388	2 x	06404
Classe M (W166)	63 AMG	11>	525/558	2 x	06381
Classe R (W251)	280	07>09	231	2 x	06404
Classe R (W251)	300	09>	231	2 x	06404
Classe R (W251)	350	06>11	272	2 x	06404
Classe R (W251)	500	05>10	306/388	2 x	06404

Modello Model	Motore Engine	Anno Year	Potenza (CV) Power (HP)	No. Filt.	Codice Code
Classe R (W251)	350 CDI BlueTEC	09>	211	2 x	06404
Classe S (W220)	280	98>05	204	2 x	06404
Classe S (W220)	320	98>02	224	2 x	06404
Classe S (W220)	350	02>05	245	2 x	06404
Classe S (W220)	430	98>05	279	2 x	06404
Classe S (W220)	500	98>05	306	2 x	06404
Classe S (W220)	55 AMG	99>05	360/500	2 x	06404
Classe S (W220)	63 AMG	01>02	444	2 x	06404
Classe S (W221)	350	06>11	272	2 x	06404
Classe S (W221)	450	06>	340	2 x	06404
Classe S (W221)	550	11>	435	2 x	06381
Classe S (W221)	400 Hybrid	09>	279	2 x	06404
Classe S (W221)	500 4-matic	06>	387	2 x	06404
Classe S (W221)	500 Blue Effic.	11>	435	2 x	06381
Classe S (W221)	63 AMG	10>	544	2 x	06381
CLC (CL203)	230	08>09	204	2 x	06404
CLC (CL203)	350	08>11	272	2 x	06404
CLK (A208)	200	97>00	136	1 x	06395
CLK (A208)	320	98>03	218	1 x	06395
CLK (A208)	200 Kompressor	98>03	163/192	1 x	06395
CLK (A208)	230 Kompressor	98>03	197/193	1 x	06395
CLK Cabrio (A209)	240	03>05	170	2 x	06404
CLK Cabrio (A209)	280	05>10	231	2 x	06404
CLK Cabrio (A209)	320	03>05	218	2 x	06404
CLK Cabrio (A209)	350	05>10	272	2 x	06404
CLK Cabrio (A209)	500	03>10	306/388	2 x	06404
CLK Cabrio (A209)	55 AMG / DTM	03>06	367/582	2 x	06404
CLK Coupe (C209)	240	02>05	170	2 x	06404
CLK Coupe (C209)	280	05>09	231	2 x	06404
CLK Coupe (C209)	320	02>05	218	2 x	06404
CLK Coupe (C209)	350	05>09	272	2 x	06404
CLK Coupe (C209)	500	02>09	306/388	2 x	06404
CLK Coupe (C209)	55 AMG / DTM	02>06	367/582	2 x	06404
CLS (C218)	550	10>	406	2 x	06381
CLS (C218)	500 Blue Effic.	10>	406	2 x	06381
CLS (C218)	63 AMG	11>	525/557	2 x	06381
CLS (C219)	280	08>09	231	2 x	06404
CLS (C219)	300	09>10	231	2 x	06404
CLS (C219)	350	04>06	272	2 x	06404
CLS (C219)	500	04>10	306/388	2 x	06404
CLS (C219)	350 CGI	06>10	292	2 x	06404
CLS (C219)	55 AMG	04>06	476	2 x	06404
SL (R129)	280	98>01	204	2 x	06404
SL (R129)	350	98>01	224	2 x	06404
SL (R129)	500	98>01	306	2 x	06404
SL (R129)	55 AMG	99>01	354	2 x	06404
SL (R230)	250	08>09	231	2 x	06404
SL (R230)	300	09>	231	2 x	06404
SL (R230)	350	03>12	245/272/316	2 x	06404
SL (R230)		01>12	306/388	2 x	06404
SL (R230)		01>08	476/517	2 x	06404
SLK (R170)	200	96>00	136	1 x	06395
SLK (R171)	280	05>09	231	2 x	06404
SLK (R171)	300	09>11	231	2 x	06404
SLK (R171)	350	04>11	272/305	2 x	06404
SLK (R171)	55 AMG	04>11	360/400	2 x	06404
SLK (R172)	200 CGI Blue Effic.	11>	184	1 x	06432
SLK (R172)	250 CGI	11>	204	1 x	06432
SLR (R199)	5.4	06>	626/650	2 x	06395
SLS (C197)	6.2 AMG	10>	571	2 x	06382

MINI

Mini / Cabrio	1.4 D	04>06	75/88	1 x	06411
Mini / Cabrio	1.6	01>05	90/116	1 x	06411

MITSUBISHI

ASX	1.6	10>	117	1 x	06430
ASX	1.8	10>	139	1 x	06430
Lancer / Sportback	1.5	08>	109	1 x	06430
Lancer / Sportback	1.6	10>	117	1 x	06430

Modello Model	Motore Engine	Anno Year	Potenza (CV) Power (HP)	No. Filt.	Codice Code
Lancer / Sportback	1.8	08>	140/143	1 x	06430
Lancer / Sportback	2.0	08>	241	1 x	06430
Lancer / Sportback	2.0 DI-D	08>	140	1 x	06430
Lancer Evoluzione EVO		08>	295	1 x	06430
Outlander	2.0	06>	147	1 x	06430
Outlander	2.2 DID	06>	140/156/177	1 x	06430
Outlander	2.4 Mivec	07>	170	1 x	06430
Outlander	3.0 V6	86>99		1 x	06430

NISSAN					
350Z	3.5 V6 / ROADSTER	03>09	280/301/313	1 x	06398
Almera	1.5 dCi	01>06	82	1 x	06413
Almera	1.5 i	00>	90/98	1 x	06398
Almera	1.8 i	00>	114/116	1 x	06398
Almera	2.0 Diesel	95>00	75	1 x	06398
Almera	2.0 i	96>	136/143	1 x	06398
Almera	2.2 DCI	00>	112/136	1 x	06398
Almera	2.2 DI	00>	110	1 x	06398
Kubistar	1.2 16V	06>08		1 x	06406
Kubistar	1.5 D	03>08		1 x	06413
Kubistar	1.6 16V	03>08	95	1 x	06401
Murano	2.5 cdi	10>	190	1 x	06398
Murano	3.5	08>	265	1 x	06398
Navarra	2.4	95>05		1 x	06398
Navarra	3.0 V6	92>05		1 x	06398
Navarra	3.2 V6	00>04		1 x	06398
Pathfinder	2.7 TD 4WD	97>04	131	1 x	06398
Pathfinder	3.0 V6	92>95		1 x	06398
Pathfinder	3.2 TD 4WD	97>04	150	1 x	06398
Pathfinder	3.3 V6 4WD	97>04	150/170	1 x	06398
Pathfinder	3.5 V6 4WD	00>04	220	1 x	06398
Patrol	4.2 6 Cyl.	88>97	165	1 x	06398
Primastar	2.0 16V	03>	120	1 x	06401
Primera	1.6 i	02>	106/109	1 x	06398
Primera	1.8 i	99>02	114	1 x	06398
Primera	1.8 i	02>	115	1 x	06398
Primera	1.9 dCi	02>	116	1 x	06398
Primera	2.0 D	90>95	75	1 x	06398
Primera	2.0 Diesel	90>96	75	1 x	06398
Primera	2.0 GT	90>96	150	1 x	06398
Primera	2.0 i	96>08	115/125/130/140/150	1 x	06398
Primera	2.0 TD	96>02	90	1 x	06398
Primera	2.2 dCi	03>08	139	1 x	06398
Primera	2.2 Di	02>08	126	1 x	06398
Terrano	2.4	93>05		1 x	06398
Terrano	3.0	90>95	148	1 x	06398
Terrano	3.0 V6	03>05		1 x	06398
Terrano	3.2 V6	00>04		1 x	06398
X-Trail	2.0	01>	140	1 x	06398
X-Trail	2.2 dCi	03>	136	1 x	06398
X-Trail	2.2 Di	03>	114	1 x	06398
X-Trail	2.5	03>		1 x	06398

OPEL					
Adam	1.4	13>	100	1 x	06420
Astra F	1.7 TD	91>98	68/82	1 x	06398
Astra G	1.2 16V	98>05	65/75	1 x	06380
Astra G	1.4	07>09	90	1 x	06380
Astra G	1.4 16V	98>05	90/101	1 x	06380
Astra G	1.6 i	98>00	75/84/103	1 x	06380
Astra G	1.7 CDTI	03>05	80	1 x	06380
Astra G	1.7 DTI 16V	00>05	75	1 x	06380
Astra G	1.7 TD	98>00	68	1 x	06380
Astra G	1.7 TD	98>02	82	1 x	06398
Astra G	1.8 16V	98>05	116/125	1 x	06380
Astra G	2.0 16V	98>05	136/160	1 x	06380
Astra G	2.0 Di	98>05	82	1 x	06380
Astra G	2.0 DTI 16V	98>05	101	1 x	06380
Astra G	2.0 OPC	98>05	192/200	1 x	06380

Modello Model	Motore Engine	Anno Year	Potenza (CV) Power (HP)	No. Filt.	Codice Code
Astra G	2.2 DTI	02>05	125	1 x	06380
Astra H	1.2	06>09	65	1 x	06380
Astra H	1.3 CDTI	05>09	90	1 x	06380
Astra H	1.4	04>09	90	1 x	06380
Astra H	1.6	04>09	103/116	1 x	06380
Astra H	1.6 Turbo	07>09	180	1 x	06395
Astra H	1.7 CDTI	07>09	110/125	1 x	06395
Astra H	1.7 CDTI	04>09	80/100	1 x	06380
Astra H	1.8	04>09	125/140	1 x	06380
Astra H	1.9 CDTI	04>09	100/120/150	1 x	06395
Astra H	2.0 Turbo	04>09	170/200/240	1 x	06380
Astra H	2.2	04>09	147	1 x	06395
Astra J	1.4	09>	87/100	1 x	06433
Astra J	1.6	09>	115	1 x	06433
Combo	1.2 i	94>01	45	1 x	06391
Combo	1.3 CDTI 16V	04>08	69	1 x	06408
Combo	1.4 16V	04>08	90	1 x	06408
Combo	1.4 i	94>01	60/82	1 x	06391
Combo	1.6	01>08	87/94/97	1 x	06408
Combo	1.7 CDTI 16V	04>08	101	1 x	06408
Combo	1.7 DI 16V	01>08	65	1 x	06408
Combo	1.7 Diesel	94>01	60	1 x	06391
Combo	1.7 DTI 16V	01>08	75	1 x	06408
Corsa	1.0	01>06	58/60	1 x	06408
Corsa	1.0	06>	60/65	1 x	06420
Corsa	1.0 i 12V	96>09	55	1 x	06391
Corsa	1.2	10>	69/80/83/86	1 x	06420
Corsa	1.2	01>06	75/80	1 x	06408
Corsa	1.2 i	93>09	45/65	1 x	06391
Corsa	1.3 CDTI	01>06	70	1 x	06408
Corsa	1.3 CDTI	06>	75/90/95	1 x	06420
Corsa	1.4	01>06	90	1 x	06408
Corsa	1.4	06>	87/90/100/120	1 x	06420
Corsa	1.4 i 16V	93>09	60/82/90/91	1 x	06391
Corsa	1.5 D	93>09	50	1 x	06391
Corsa	1.5 D	87>93	50/67	1 x	06398
Corsa	1.5 TD	93>09	67	1 x	06391
Corsa	1.6	07>	150/192/210	1 x	06420
Corsa	1.6 i 16V	93>09	106/109	1 x	06391
Corsa	1.7 CDTI	06>	125/130	1 x	06420
Corsa	1.7 CDTI 16V	01>06	100	1 x	06408
Corsa	1.7 D	96>09	60	1 x	06391
Corsa	1.7 DI	01>06	65	1 x	06408
Corsa	1.7 DTI	01>06	75	1 x	06408
Corsa	1.8 16V	01>06	125	1 x	06408
Frontera	2.2 i	95>98	115	1 x	06372
Frontera	2.3 TD	92>98	100	1 x	06372
Frontera	2.4 i	92>98	125	1 x	06372
Frontera	2.5 TDS	96>98	115	1 x	06372
Frontera	2.8 TDI	95>98	113	1 x	06372
Meriva	1.3 CDTI	05>10	69/75	1 x	06408
Meriva	1.4	04>10	90	1 x	06408
Meriva	1.6	03>10	87/101/105/180	1 x	06408
Meriva	1.7 CDTI 16V	03>10	101/125	1 x	06408
Meriva	1.7 DTI	03>10	65/75	1 x	06408
Meriva	1.8	03>10	125	1 x	06408
Signum	2.8 V6 turbo	05>08	230/255	1 x	06380
Tigra	1.4 16V	94>00	90	1 x	06391
Tigra	1.6 16V	94>98	106	1 x	06391
Tigra TwinTop	1.3 CDTI	04>09	69	1 x	06408
Tigra TwinTop	1.4i	04>09	90	1 x	06408
Tigra TwinTop	1.8i	04>09	125	1 x	06408
Vectra	1.7 TD	90>95	82	1 x	06398
Vivaro	2.0	01>	117/120	1 x	06401
Zafira	1.6	05>	94/105/115	1 x	06380
Zafira	1.6	99>05	97/101	1 x	06380
Zafira	1.6 CNG Turbo	05>	150	1 x	06395
Zafira	1.7 CDTI	08>	110/125	1 x	06395
Zafira	1.8	05>	140	1 x	06380
Zafira	1.8 16V	99>05	116/125	1 x	06380

Modello Model	Motore Engine	Anno Year	Potenza (CV) Power (HP)	No. Filt.	Codice Code
Zafira	1.9 CDTI	05>	101/120/150	1 x	06395
Zafira	2.0	05>	170/200/240	1 x	06380
Zafira	2.0 16V DTI	99>05	82/101	1 x	06380
Zafira	2.0 OPC	01>05	192/200	1 x	06380
Zafira	2.2	05>	150	1 x	06395
Zafira	2.2 16V	00>05	147	1 x	06395
Zafira	2.2 16V DTI	00>05	117/125	1 x	06380
Zafira C	1.8	11>	120/140	1 x	06433

PEUGEOT

106	1.1	91>04	60	1 x	06373
106	1.4	91>04	75/94	1 x	06373
106	1.6	91>04	88/89/101/103	1 x	06373
106	1.6 S16	96>04	118	1 x	06400
107	1.4 HDI	05>	54	1 x	06385
306	1.1 i	94>01	60	1 x	06373
306	1.4	94>01	75	1 x	06373
306	1.6	94>00	89	1 x	06373
306	1.9 SRDT	93>97	90	1 x	06375
306	2.0 i 16v	93>01	150/152/163	1 x	06375
508	2.0 HDI	10>	140/163/200	1 x	06410
508	2.2 HDI	10>	204	1 x	06410
1007	1.4 16V	05>	88	1 x	06415
1007	1.4 HDI	05>10	68	1 x	06385
1007	1.4 i	05>	75	1 x	06415
1007	1.6 16V	05>	109	1 x	06415
1007	1.6 HDI	07>	109	1 x	06414
3008	1.6 HDI	10>	109	1 x	06414
4007	2.2 HDI	08>	156	1 x	06430
4007	2.4	08>	170	1 x	06430
5008	1.6 HDI	10>	110	1 x	06414
205 / Cabrio	1.3 Rally	87>90	101	1 x	06375
205 / Cabrio	1.6	86>94	103/116/120	1 x	06375
205 / Cabrio	1.9	86>94	101/102/120/128	1 x	06375
206 / CC / SW	1.4 HDI	01>	68	1 x	06385
206 / CC / SW	1.6 HDI 16V	98>07	110	1 x	06414
207 / CC / SW	1.4 16V	06>	88	1 x	06415
207 / CC / SW	1.4 HDI	06>10	68	1 x	06385
207 / CC / SW	1.6 16V	06>	109	1 x	06415
207 / CC / SW	1.6 HDI	06>	90/109	1 x	06414
307 / CC / SW	1.4 HDI	01>08	68	1 x	06385
307 / CC / SW	1.4 XR	01>09	75	1 x	06371
307 / CC / SW	1.6 16V	01>05	109	1 x	06371
307 / CC / SW	1.6 HDI	04>08	90/109	1 x	06414
307 / CC / SW	2.0	02>05	136	1 x	06371
307 / CC / SW	2.0 16V	05>08	140/177	1 x	06371
307 / CC / SW	2.0 HDI	00>08	90/107/136	1 x	06371
308 / CC / SW	1.6 HDI	07>	90/109	1 x	06414
405 / SW	1.4 i	91>95	75	1 x	06373
405 / SW	2.0	92>95	152/196	1 x	06375
407 / SW	2.0 HDI	08>	140/136/163	1 x	06410
407 / SW	2.2 HDI	04>11	163/170	1 x	06430
407 / SW	2.4	04>11	170	1 x	06430
Bipper / Tepee	1.3 HDI	10>	75	1 x	06427
Bipper / Tepee	1.4 HDI	08>	68	1 x	06385
Partner	1.1 i	97>07	60	1 x	06373
Partner	1.4 i	02>08	75	1 x	06415
Partner	1.6 16V	02>08	109	1 x	06415
Partner	1.6 HDI	06>08	75/90	1 x	06414
Partner	1.6 HDI	08>	75/90/109	1 x	06414
Ranch	1.1 i	97>07	60	1 x	06373
Ranch	1.4 i	02>08	75	1 x	06415
Ranch	1.6 16V	02>08	109	1 x	06415
Ranch	1.6 HDI	06>08	75/90	1 x	06414

PORSCHE

911 (996)	3.4	97>05	300/320	1 x	06389
911 (996/997)	3.6	02>08	320/345	1 x	06389
911 (996/997)	3.8	04>06	355	1 x	06389
911 (996)	3.6 GT2	01>05	462/483	1 x	06379

Modello Model	Motore Engine	Anno Year	Potenza (CV) Power (HP)	No. Filt.	Codice Code
911 (996)	3.6 GT3	99>05	360/381	1 x	06379
911 (996)	3.6 Turbo	00>05	420/450	1 x	06379
911 (997)	3.6 GT3	06>11	415	1 x	06379
911 (997)	3.6 Turbo	06>09	480	1 x	06379
911 (997)	3.8 GT3	09>	435	1 x	06379
Boxster / 986	2.5	96>99	204	1 x	06374
Boxster / 986	2.7	99>04	220/228	1 x	06374
Boxster / 986	3.2 S	00>04	252/260/266	1 x	06374
Cayenne - 955	3.0 D DPF	10>	239/245	1 x	06418
Cayenne - 955	3.0 S Hybrid	10>	380	1 x	06418
Cayenne - 955	3.0 TDI	09>10	240	2 x	06418
Cayenne - 955	3.2	03>07	250	1 x	06418
Cayenne - 955	3.6	07>10	290	1 x	06418
Cayenne - 955	3.6	11>	300	1 x	06418
Cayenne - 955	4.5 S	03>07	340	2 x	06418
Cayenne - 955	4.5 Turbo	03>07	450	2 x	06418
Cayenne - 955	4.5 Turbo S	04>06	500	2 x	06418
Cayenne - 955	4.5 Turbo S	06>07	521	2 x	06418
Cayenne - 955	4.8 GTS	07>10	405	2 x	06418
Cayenne - 955	4.8 S	07>10	385	2 x	06418
Cayenne - 955	4.8 S	11>	400	2 x	06418
Cayenne - 955	4.8 Turbo	11>	500/540	2 x	06418
Cayenne - 955	4.8 Turbo S	07>10	500/540/550	2 x	06418

RENAULT

Clio	1.2 16V	01>05	75	1 x	06406
Clio	1.4 16V	99>05	95/98	1 x	06401
Clio	1.5 D	04>05	68	1 x	06413
Clio	1.5 Dci	01>05	64/80/82/101	1 x	06413
Clio	1.6 16V	98>05	110	1 x	06401
Espace	2.0	98>	133/136/139/140	1 x	06401
Grand Scenic	1.4 16V	09>	130	1 x	06426
Grand Scenic	1.5 dCi	04>08	101	1 x	06426
Grand Scenic	1.5 dCi	09>	86/95/106/110	1 x	06426
Grand Scenic	1.6 16V	09>	110	1 x	06426
Grand Scenic	1.6 16V	04>08	113	1 x	06426
Grand Scenic	1.6 dCi	11>	130	1 x	06426
Grand Scenic	1.9 dCi	11>	131	1 x	06426
Grand Scenic	1.9 dCi	04>08	110/120/131	1 x	06426
Grand Scenic	2.0	04>08	135/163	1 x	06426
Grand Scenic	2.0 dCi	05>08	150	1 x	06426
Grand Scenic	2.0 dCi	09>	150/160	1 x	06426
Kangoo	1.2 16V	01>07	75	1 x	06406
Kangoo	1.5 dCi	08>	68/86/103	1 x	06426
Kangoo	1.6	01>07	82/87/95/106	1 x	06401
Kangoo Express	1.2 16V	01>07	75	1 x	06406
Kangoo Express	1.5 Dci	01>07	57/61/65/68/82/84	1 x	06413
Kangoo Express	1.5 dCi	08>	68/86/90/103/110	1 x	06426
Kangoo Express	1.6	01>07	82/87/95/98/106	1 x	06401
Laguna / SW	1.6	97>06	107	1 x	06401
Laguna / SW	1.8	98>06	116/117/120/121	1 x	06401
Laguna / SW	2.0	98>07	135/139/170/204	1 x	06401
Megane/Cabrio/Coupe/SW	1.2 TCE	12>	116	1 x	06426
Megane/Cabrio/Coupe/SW	1.4	96>02	70/95	1 x	06401
Megane/Cabrio/Coupe/SW	1.4 TCE	09>	131	1 x	06426
Megane/Cabrio/Coupe/SW	1.5 DCI	02>08	82/86/101/103/106	1 x	06417
Megane/Cabrio/Coupe/SW	1.5 dCi	08>	86/90/106/110/131	1 x	06426
Megane/Cabrio/Coupe/SW	1.6	99>02	107	1 x	06401
Megane/Cabrio/Coupe/SW	1.6	02>08	105/112/113	1 x	06417
Megane/Cabrio/Coupe/SW	1.6 16V	08>	110/112	1 x	06426
Megane/Cabrio/Coupe/SW	1.6 dCi	11>	130	1 x	06426
Megane/Cabrio/Coupe/SW	1.8	01>02	115	1 x	06401
Megane/Cabrio/Coupe/SW	1.9 dCi	08>	130	1 x	06426
Megane/Cabrio/Coupe/SW	1.9 DCI	02>08	90/92/110/115/120/130	1 x	06417
Megane/Cabrio/Coupe/SW	2.0	02>08	139	1 x	06401
Megane/Cabrio/Coupe/SW	2.0 16V	02>08	135/163/225/230	1 x	06417
Megane/Cabrio/Coupe/SW	2.0 16V	08>	140/180	1 x	06426
Megane/Cabrio/Coupe/SW	2.0 dCi	08>	160	1 x	06426
Megane/Cabrio/Coupe/SW	2.0 DCI	05>08	150/173	1 x	06417

Modello Model	Motore Engine	Anno Year	Potenza (CV) Power (HP)	No. Filtr.	Codice Code
Megane/Cabrio/Coupe/SW	2.0 TCE RS	09>	250	1 x	06426
Modus	1.4	04>	98	1 x	06413
Scenic	1.4	99>03	95	1 x	06401
Scenic	1.5 dCi	03>08	82/86/101/103/106	1 x	06426
Scenic	1.6	99>03	107	1 x	06401
Scenic	1.6	03>08	112/113	1 x	06417
Scenic	1.8	00>03	115/116	1 x	06401
Scenic	1.9 dCi	03>08	110/116/120/131	1 x	06426
Scenic	2.0	99>03	139/140	1 x	06401
Scenic	2.0 16V	03>08	135/163	1 x	06426
Scenic	2.0 dCi	05>08	150	1 x	06426
Scenic X-Mod	1.2 TCE	12>	116	1 x	06426
Scenic X-Mod	1.4 TCE	09>	130	1 x	06426
Scenic X-Mod	1.5 dCi	09>	86/95/106/110	1 x	06426
Scenic X-Mod	1.6 16V	09>	110	1 x	06426
Scenic X-Mod	1.6 dCi	11>	130	1 x	06426
Scenic X-Mod	1.9 dCi	11>	131	1 x	06426
Scenic X-Mod	2.0 dCi	09>	150/160	1 x	06426
Traffic	2.0	01>05	120	1 x	06401
Twingo	1.2 16V	01>06	60/75	1 x	06406
Twingo	1.5 dCi	07>	64/84	1 x	06413

ROVER					
75	2.0 CDTi	99>	116/131	1 x	06403

SEAT					
Alhambra	1.4 TSI	10>	150	1 x	06387
Alhambra	1.8 Turbo	96>00	150	1 x	06382
Alhambra	1.9 TDI	96>00	90/110	1 x	06382
Alhambra	2.0 i	96>00	115	1 x	06382
Alhambra	2.0 TDI	10>	115/136/140/170	1 x	06387
Alhambra	2.0 TSI	10>	200	1 x	06387
Altea	1.4 16V	06>	86	1 x	06431
Altea	1.6 TDI	09>	90/105	1 x	06387
Altea	1.8 TFSI	06>	160	1 x	06387
Altea	1.9 TDI	04>	90/105	1 x	06387
Altea	2.0 TDI	04>	136/140/170	1 x	06387
Altea	2.0 TFSI	06>09	200	1 x	06386
Altea XL	1.4 16V	06>	86	1 x	06431
Altea XL	1.6 TDI	09>	90/105	1 x	06387
Altea XL	1.8 TFSI	06>	160	1 x	06387
Altea XL	1.9 TDI	04>	90/105	1 x	06387
Altea XL	2.0 TDI	04>	136/140/170	1 x	06387
Altea XL	2.0 TFSI	06>09	200/211	1 x	06386
Cordoba	1.4 16v	99>02	75	1 x	06376
Cordoba	1.4 16V	06>09	86	1 x	06431
Cordoba	1.4 16V	02>07	75/100	1 x	06416
Cordoba	1.4 TDI	02>09	70/75/80	1 x	06412
Cordoba	1.6 16V	06>09	105	1 x	06431
Cordoba	1.6 i	99>02	101	1 x	06383
Cordoba	1.6 i	94>99	75/101	1 x	06376
Cordoba	1.8 i	93>99	90/129	1 x	06376
Cordoba	1.8 T 20V	99>02	156	1 x	06383
Cordoba	1.9 D	93>96	64/68	1 x	06376
Cordoba	1.9 SDI	96>99	64	1 x	06376
Cordoba	1.9 SDI	99>02	68	1 x	06383
Cordoba	1.9 SDI	02>	64/100/130	1 x	06412
Cordoba	1.9 TD	93>96	75	1 x	06376
Cordoba	1.9 TDI	96>99	90/110	1 x	06376
Cordoba	1.9 TDI	99>02	90/110	1 x	06383
Cordoba	2.0 16V	02>09	115	1 x	06412
Cordoba	2.0 i	93>99	115/150	1 x	06376
Exeo / ST	1.6	09>	102	1 x	06428
Exeo / ST	1.8 T	08>	150	1 x	06428
Exeo / ST	1.8 TSI	10>	120/160	1 x	06428
Exeo / ST	2.0 TDI	08>	120/143/170	1 x	06428
Exeo / ST	2.0 TSI	09>	200/211	1 x	06428
Ibiza	1.2	09>12	60	1 x	06412
Ibiza	1.2 12V	08>12	70	1 x	06412
Ibiza	1.2 TDI	10>	75	1 x	06421

Modello Model	Motore Engine	Anno Year	Potenza (CV) Power (HP)	No. Filtr.	Codice Code
Ibiza	1.4 16V	06>08	86	1 x	06431
Ibiza	1.4 16V	08>	86	1 x	06431
Ibiza	1.4 16V	02>08	75/100	1 x	06416
Ibiza	1.4 TDI	08>10	80	1 x	06412
Ibiza	1.4 TDI	03>08	70/75/80	1 x	06412
Ibiza	1.6 16V	06>08	105	1 x	06431
Ibiza	1.6 16V	08>	105	1 x	06431
Ibiza	1.6 MPI	96>99	100	1 x	06376
Ibiza	1.6 MPI	99>02	100	1 x	06383
Ibiza	1.8	93>96	90/129	1 x	06376
Ibiza	1.8 T 20V	04>08	150/180	1 x	06412
Ibiza	1.8 T CUPRA	99>02	156	1 x	06383
Ibiza	1.9 D	96>99	64/68	1 x	06376
Ibiza	1.9 SDI	02>06	64	1 x	06412
Ibiza	1.9 SDi	96>99	64	1 x	06376
Ibiza	1.9 SDi	99>02	68	1 x	06383
Ibiza	1.9 TD	93>96	75	1 x	06376
Ibiza	1.9 TDI	02>08	101/130/160	1 x	06412
Ibiza	1.9 TDI	08>09	90/105	1 x	06412
Ibiza	1.9 TDI	96>99	90/110	1 x	06376
Ibiza	1.9 TDI	99>02	90/110	1 x	06383
Ibiza	2.0	08>12	115	1 x	06412
Ibiza	2.0 MPI GTI	93>99	115/150	1 x	06376
Ibiza IV	1.2 TSI	10>	105	1 x	06421
Ibiza IV	1.4 16V TSI	09>	150/180	1 x	06421
Ibiza IV	1.6 TDI 16V	09>	90/105	1 x	06421
Leon	1.4 16V	07>	86	1 x	06431
Leon	1.6	00>05	100/102	1 x	06377
Leon	1.6 16V	00>06	105	1 x	06376
Leon	1.6 16V	00>06	105	1 x	06416
Leon	1.6 TDI	10>	90/105	1 x	06387
Leon	1.8	00>05	125/180/210/225	1 x	06377
Leon	1.8 TSI	07>	160	1 x	06387
Leon	1.9 SDI	00>03	68	1 x	06377
Leon	1.9 TDI	00>05	90/101/110/130/150	1 x	06377
Leon	1.9 TDI	05>	90/105	1 x	06387
Leon	2.0 TDI	05>	136/140/170	1 x	06387
Leon	2.0 TFSI	05>09	185/200	1 x	06386
Leon	2.0 TSI	09>	210	1 x	06387
Leon	2.0 TSI	06>	240/265	1 x	06386
Leon	2.8 VR6 24V	00>05	204	1 x	06377
Toledo	1.2	12>	75	1 x	06412
Toledo	1.2 TSI	12>	86/105	1 x	06421
Toledo	1.4 16V	99>06	75	1 x	06416
Toledo	1.4 TSI	12>	122	1 x	06421
Toledo	1.6 16V	99>00	100	1 x	06377
Toledo	1.6 16V	99>00	105	1 x	06416
Toledo	1.6 i	91>99	71/73/75/101	1 x	06376
Toledo	1.6 TDI	12>	105	1 x	06421
Toledo	1.8	91>99	88/90/125/133	1 x	06376
Toledo	1.8 20V	99>06	125/180	1 x	06377
Toledo	1.8 TFSI	07>11	160	1 x	06387
Toledo	1.9 D	91>99	64/68	1 x	06376
Toledo	1.9 SDI	99>04	68	1 x	06377
Toledo	1.9 TD	91>99	75	1 x	06376
Toledo	1.9 TDI	04>11	105	1 x	06387
Toledo	1.9 TDI	95>99	90/110	1 x	06376
Toledo	1.9 TDI	99>06	90/110/130/150	1 x	06377
Toledo	2.0 i	91>99	115	1 x	06376
Toledo	2.0 TDI	04>09	136/140/170	1 x	06387
Toledo	2.0 TFSI	05>09	200	1 x	06386
Toledo	2.3	99>06	150/170	1 x	06377

SKODA					
Fabia	1.0 i	99>02	50	1 x	06412
Fabia	1.2	02>07	54	1 x	06412
Fabia	1.2	06>10	60/70	1 x	06412
Fabia	1.2 TDI	11>	75	1 x	06421
Fabia	1.2 TSI	10>	86/105	1 x	06421

Modello Model	Motore Engine	Anno Year	Potenza (CV) Power (HP)	No. Filt.	Codice Code
Fabia	1.4	07>10	86	1 x	06431
Fabia	1.4 i	99>07	60/68	1 x	06412
Fabia	1.4 i 16V	06>07	80	1 x	06431
Fabia	1.4 i 16V	99>08	75/100	1 x	06416
Fabia	1.4 TDI	03>07	70/75/80	1 x	06412
Fabia	1.4 TDI	07>10	70/80	1 x	06412
Fabia	1.4 TSI	10>	180	1 x	06421
Fabia	1.6	07>10	105	1 x	06416
Fabia	1.6 TDI	10>	75/90/105	1 x	06421
Fabia	1.9 Sdi	99>07	64	1 x	06412
Fabia	1.9 TDI	07>10	105	1 x	06412
Fabia	1.9 TDI	00>07	100/130	1 x	06412
Fabia	2.0 i	99>07	115	1 x	06412
Felicia	1.3 MPI	98>01	54/58/68	1 x	06376
Felicia	1.6	98>01	75	1 x	06376
Felicia	1.9 Diesel	98>01	64	1 x	06376
Octavia	1.4	99>10	60	1 x	06377
Octavia	1.4	05>13	80	1 x	06416
Octavia	1.6	97>10	101/102	1 x	06377
Octavia	1.6 TDI	09>13	105	1 x	06387
Octavia	1.8	96>10	125/150/180	1 x	06377
Octavia	1.8 TFSI	07>13	160	1 x	06387
Octavia	1.9 SDI	97>10	68	1 x	06377
Octavia	1.9 TDI	05>10	105	1 x	06387
Octavia	1.9 TDI	96>10	90/100/110/130	1 x	06377
Octavia	2.0	99>10	116/120	1 x	06377
Octavia	2.0 TDI 16V	05>13	136/140/170	1 x	06387
Octavia	2.0 TFSI	05>08	200	1 x	06386
Octavia	2.0 TSI	08>13	200	1 x	06387
Rapid	1.2	13>	75	1 x	06412
Rapid	1.2 TSI	12>	86	1 x	06421
Rapid	1.2 TSI	12>	105	1 x	06421
Rapid	1.4 TSI	12>	122	1 x	06421
Rapid	1.6 TDI	12>	105	1 x	06421
Roomster	1.2	06>	64/70	1 x	06412
Roomster	1.2 TDI	10>	75	1 x	06421
Roomster	1.2 TSI	10>	86/105	1 x	06421
Roomster	1.4	06>	86	1 x	06431
Roomster	1.4 TDI	06>10	70/80	1 x	06412
Roomster	1.6	06>	105	1 x	06416
Roomster	1.6 TDI	10>	90/105	1 x	06421
Roomster	1.9 TDI	06>10	101/105	1 x	06412
Superb	1.6 TDI	10>	105	1 x	06387
Superb	1.8 TFSI	08>	160	1 x	06387
Superb	1.8 Turbo	02>08	150	1 x	06372
Superb	1.9 TDI	08>	105	1 x	06387
Superb	1.9 TDI	02>08	101/105/115/130	1 x	06372
Superb	2.0	10>	200	1 x	06387
Superb	2.0 i	02>08	115	1 x	06372
Superb	2.0 TDI	05>08	140	1 x	06372
Superb	2.0 TDI	08>	140/170	1 x	06387
Superb	2.5 TDI	02>08	155/163	1 x	06372
Superb	2.8 i V6	02>08	193	1 x	06372
Yeti	1.6 TDI	09>	105	1 x	06387
Yeti	1.8 TFSI	09>	152/160	1 x	06387
Yeti	2.0 TDI 4x4	09>	110/140/170	1 x	06387

SUBARU

Modello Model	Motore Engine	Anno Year	Potenza (CV) Power (HP)	No. Filt.	Codice Code
Forester	2.0	97>07	122/125/158/170/177	1 x	06398
Forester	2.5	03>07	211/230	1 x	06398
Impreza	1.5	06>07	105	1 x	06398
Impreza	1.6 i	92>00	90	1 x	06398
Impreza	1.8	92>00	103	1 x	06398
Impreza	2.0	95>00	115/125/211/218	1 x	06398
Impreza	2.0	00>07	160/218/225/265	1 x	06398
Impreza	2.5	05>07	230/280	1 x	06398
Legacy	1.8	89>93	103	1 x	06398
Legacy	2.0	91>99	116/200	1 x	06398
Legacy	2.2	89>99	131/136	1 x	06398

Modello Model	Motore Engine	Anno Year	Potenza (CV) Power (HP)	No. Filt.	Codice Code
Legacy	2.5	96>99	150	1 x	06398
Outback	2.0	94>99	116	1 x	06398
Outback	2.2	96>99	131	1 x	06398
Outback	2.5	96>99	150	1 x	06398
SVX	3.3 i 24V	91>96	220/230	1 x	06398
SX4	1.6 DDiS	07>13	90	1 x	06414

TOYOTA

Aygo	1.4 D	05>	54	1 x	06385
------	-------	-----	----	-----	--------------

VOLKSWAGEN

Bora	1.4 TSI	07>10	140/160/170	1 x	06387
Bora	1.6	97>05	101/102	1 x	06377
Bora	1.6 16V	01>05	105	1 x	06416
Bora	1.6 D	09>10	90	1 x	06387
Bora	1.6 FSI	02>05	110	1 x	06377
Bora	1.6 TDI	09>10	105	1 x	06387
Bora	1.8	97>05	125/150/180	1 x	06377
Bora	1.9 SDi	97>05	68	1 x	06377
Bora	1.9 TDI	05>10	105	1 x	06387
Bora	1.9 TDI	97>05	90/101/110/115/130/150	1 x	06377
Bora	2.0	98>06	115/116	1 x	06377
Bora	2.0 TDI	05>10	136/140/170	1 x	06387
Bora	2.0 TFSI	05>10	200	1 x	06387
Bora	2.3 V5	97>00	150/170	1 x	06377
Bora	2.8 i V6	99>05	204	1 x	06377
Bora	R32	02>05	241	1 x	06377
Caddy	1.4	04>	75/80	1 x	06431
Caddy	1.6	96>00	75	1 x	06376
Caddy	1.9 SDI	96>00	64	1 x	06376
Caddy	1.9 TDI	05>	75	1 x	06387
Caddy	1.9 TDI	96>04	90	1 x	06376
Caddy	1.9 TDI	04>	105	1 x	06387
Caddy	2.0 TDI	07>	85/110/140/170	1 x	06387
Eos	1.4 TSI	08>	160	1 x	06387
Eos	2.0 TFSI	06>08	200	1 x	06386
Eos	2.0 TFSI	09>	200	1 x	06387
Eos	2.0 TDI	06>	140	1 x	06387
Eos	2.0 TSI	09>	210	1 x	06387
Fox	1.2	05>11	55/60	1 x	06412
Fox	1.4 TDI	05>11	70	1 x	06412
Golf I	1.8	74>89	112	1 x	06412
Golf IV	1.6	97>00	101/102	1 x	06377
Golf IV	1.6 16V	01>05	105	1 x	06416
Golf IV	1.6 FSI	02>05	110	1 x	06377
Golf IV	1.8	97>05	125/150/180	1 x	06377
Golf IV	1.9 SDi	97>05	68	1 x	06377
Golf IV	1.9 TDI	97>05	90/101/110/115/130/150	1 x	06377
Golf IV	2.0	98>06	115/116	1 x	06377
Golf IV	2.3 V5	97>00	150/170	1 x	06377
Golf IV	2.8 i V6	99>05	204	1 x	06377
Golf IV	R32	02>05	241	1 x	06377
Golf Plus	1.4 16V	03>08	75	1 x	06416
Golf Plus	1.4 16V	05>08	80	1 x	06431
Golf Plus	1.4 TSI	06>	140/160/170	1 x	06387
Golf Plus	1.6 TDI	09>	105	1 x	06387
Golf Plus	1.9 TDI	03>08	90/105	1 x	06387
Golf Plus	2.0 TDI	06>	136/140	1 x	06387
Golf V	1.4 16V	03>08	75	1 x	06416
Golf V	1.4 16V	05>08	80	1 x	06431
Golf V	1.4 TSI	06>	140/160/170	1 x	06387
Golf V	1.9 TDI	03>08	90/105	1 x	06387
Golf V	2.0 TDI	03>08	136/140/170	1 x	06387
Golf V	2.0 TFSI	04>08	200	1 x	06386
Golf V	2.0 TFSI	04>08	200	1 x	06387
Golf V	2.0 TFSI	06>08	230	1 x	06386
Golf VI	1.4 16V	08>	80	1 x	06431
Golf VI	1.4 TSI	08>	160	1 x	06387
Golf VI	1.6 TDI	09>	90/105	1 x	06387

Modello Model	Motore Engine	Anno Year	Potenza (CV) Power (HP)	No. Filtr.	Codice Code
Golf VI	1.8 TSI	09>	160	1 x	06387
Golf VI	2.0	09>	256/265/270	1 x	06386
Golf VI	2.0 TDI	08>	110/140/170	1 x	06387
Golf VI	2.0 TSI	09>	210	1 x	06387
Golf VI	2.0 TSI	11>	235	1 x	06386
Jetta	1.4 TSI	07>	140/160/170	1 x	06387
Jetta	1.6	97>00	101/102	1 x	06377
Jetta	1.6 16V	01>05	105	1 x	06416
Jetta	1.6 D	09>10	90	1 x	06387
Jetta	1.6 FSI	02>05	110	1 x	06377
Jetta	1.6 TDI	09>	105	1 x	06387
Jetta	1.8	74>89	112	1 x	06412
Jetta	1.8	97>05	125/150/180	1 x	06377
Jetta	1.9 SDi	97>05	68	1 x	06377
Jetta	1.9 TDI	05>10	105	1 x	06387
Jetta	1.9 TDI	97>05	90/101/110/ 115/130/150	1 x	06377
Jetta	2.0	98>06	115/116	1 x	06377
Jetta	2.0 TDI	10>	110/140	1 x	06387
Jetta	2.0 TDI	05>10	136/140/170	1 x	06387
Jetta	2.0 TFSI	05>10	200	1 x	06387
Jetta	2.0 TSI	10>	147	1 x	06387
Jetta	2.3 V5	97>00	150/170	1 x	06377
Jetta	2.8 i V6	99>05	204	1 x	06377
Jetta	R32	02>05	241	1 x	06377
Maggiolino	1.4 TSI	11>	160	1 x	06387
Maggiolino	1.6 TDI	11>	105	1 x	06387
Maggiolino	2.0 TDI	11>	140	1 x	06387
Maggiolino	2.0 TSI	11>	200	1 x	06387
Multivan	2.0 TDI	09>	84/102/140/180	1 x	06384
New Beetle	1.4	99>00	75	1 x	06376
New Beetle	1.6	99>	100/102	1 x	06377
New Beetle	1.8	01>05	150/180	1 x	06377
New Beetle	1.9 TDI	98>	90/101/105	1 x	06377
New Beetle	2.0	98>	115	1 x	06377
New Beetle	2.3 V5	99>	170	1 x	06377
New Beetle	2.5	05>	150	1 x	06377
New Beetle	3.2 i RS	00>01	225	1 x	06377
Passat / CC / Variant	1.4 TSI	09>	150/160	1 x	06387
Passat / CC / Variant	1.6	96>05	101/102	1 x	06372
Passat / CC / Variant	1.6 TDI DPF	09>	105	1 x	06387
Passat / CC / Variant	1.8	96>05	125/130/150	1 x	06372
Passat / CC / Variant	1.8 TSI	07>	160	1 x	06387
Passat / CC / Variant	1.9 TDI	05>	105	1 x	06387
Passat / CC / Variant	1.9 TDI	96>05	90/101/110/ 115/130	1 x	06372
Passat / CC / Variant	2.0	00>05	115/120	1 x	06372
Passat / CC / Variant	2.0 FSI	05>	200	1 x	06386
Passat / CC / Variant	2.0 TDI	03>05	136	1 x	06372
Passat / CC / Variant	2.0 TDI	05>	110/120/122	1 x	06387
Passat / CC / Variant	2.0 TDI	05>	136/140/143/170	1 x	06387
Passat / CC / Variant	2.0 TSI	08>	200	1 x	06386
Passat / CC / Variant	2.0 TSI	10>	210	1 x	06387
Passat / CC / Variant	2.0 TSI	10>	211	1 x	06386
Passat / CC / Variant	2.3 V5	96>05	150/170	1 x	06372
Passat / CC / Variant	2.5 V6 TDI	98>05	150/163/180	1 x	06372
Passat / CC / Variant	2.8 i	96>99	180/193	1 x	06372
Passat / CC / Variant	4.0 V8	01>05	275	1 x	06372
Polo	1.2	02>08	54/60/69	1 x	06412
Polo	1.2	09>	60/70	1 x	06412
Polo	1.2 TDI	09>	75	1 x	06421
Polo	1.2 TSI	09>	105	1 x	06421
Polo	1.4	09>	85	1 x	06431
Polo	1.4 16V	06>08	80	1 x	06431
Polo	1.4 16V	01>04	75/101	1 x	06416
Polo	1.4 TDI	01>08	70/75/80	1 x	06412
Polo	1.4 TSI DSG GTI	10>	180	1 x	06421
Polo	1.6	11>	82	1 x	06431
Polo	1.6 16V	06>08	105	1 x	06431
Polo	1.6 16V GTI	99>01	125	1 x	06376
Polo	1.6 TDI DPF	09>	75/90/105	1 x	06421

Modello Model	Motore Engine	Anno Year	Potenza (CV) Power (HP)	No. Filtr.	Codice Code
Polo	1.8 GTI	05>08	150/180	1 x	06412
Polo	1.9 SDi	01>08	64	1 x	06412
Polo	1.9 SDi	96>99	64	1 x	06376
Polo	1.9 TDI	01>08	101/130	1 x	06412
Scirocco	1.4 TSI	08>	160	1 x	06387
Scirocco	2.0 TDI	08>	136/140/170	1 x	06387
Scirocco	2.0 TSI	08>	200/210	1 x	06387
Scirocco	2.0 TSI	10>	256/265	1 x	06386
Sharan	1.4 TSI	10>	150	1 x	06387
Sharan	1.8 T	97>10	150	1 x	06382
Sharan	2.0	95>10	115	1 x	06382
Sharan	2.0 TDI	10>	136/140/170	1 x	06387
Sharan	2.0 TSI	10>	200	1 x	06387
Sharan	2.8 V6	95>10	174/204	1 x	06382
T5 Transporter	2.0 TDI	09>	84/102/140/180	1 x	06384
T5 Transporter	2.5 TDI	03>09	130/164/173	1 x	06384
T5 Transporter	3.2	03>09	231/235	1 x	06384
Tiguan	1.4 TSI	07>	150/160	1 x	06387
Tiguan	2.0 TDI	07>	110/136/140/ 163/170	1 x	06387
Tiguan	2.0 TFSI	07>	170/200/211	1 x	06387
Tiguan	2.0 TSI	11>	180	1 x	06387
Touran	1.4 TSI	06>	140/150/170	1 x	06387
Touran	1.6 TDI	10>	90/105	1 x	06387
Touran	1.9 TDI	03>	90/100/105	1 x	06387
Touran	2.0 TDI	03>	136/140/170	1 x	06387
Touareg	2.5 TDI R5	03>10	174	1 x	06418
Touareg	3.0 TDI V6	10>	204/240/245/333	1 x	06418
Touareg	3.0 TDI V6	04>10	224/240	1 x	06418
Touareg	3.2 V6	02>06	220	1 x	06418
Touareg	3.6 FSI V6	10>	280	1 x	06418
Touareg	3.6 V6 FSI	02>10	280	1 x	06418
Touareg	4.2 FSI V8	11>	360	1 x	06418
Touareg	4.2 TDI V8	10>	340	1 x	06418
Touareg	4.2 V8	02>06	310	2 x	06418
Touareg	4.2 V8 FSI	07>10	350	2 x	06418
Touareg	5.0 TDI	02>10	313/350	2 x	06418
Touareg	6.0 W12	04>10	450	2 x	06418

VOLVO

Modello Model	Motore Engine	Anno Year	Potenza (CV) Power (HP)	No. Filtr.	Codice Code
C30	1.6	07>	100	1 x	06416
C30	1.6 16V	07>	100	1 x	06423
C30	1.6 D	06>	109	1 x	06423
C30	1.8	07>	125	1 x	06416
C30	1.8 Flexfuel	07>	125	1 x	06423
C30	2.0	07>	145	1 x	06416
C30	2.0 Flexfuel	07>	145	1 x	06423
C70	2.0 D	08>09	136	1 x	06423
S40	1.6	05>07	100	1 x	06416
S40	1.6 16V	07>12	100	1 x	06423
S40	1.6 D	05>12	110/115	1 x	06423
S40	1.8	04>07	125	1 x	06416
S40	1.8 Flexfuel	07>12	125	1 x	06423
S40	2.0	07>12	145	1 x	06416
S40	2.0 D	07>09	136	1 x	06423
S40	2.0 Flexfuel	07>12	145	1 x	06423
V40	1.5 D2	12>	114	1 x	06423
V40	1.6 GTDI	12>	150/180	1 x	06423
V40 Cross-Country	1.6	13>	115/180	1 x	06423
V50	1.6	05>07	100	1 x	06416
V50	1.6 16V	07>	100	1 x	06423
V50	1.6 D / D2	07>	110/114	1 x	06423
V50	1.8	04>07	125	1 x	06416
V50	1.8 Flexfuel	07>	125	1 x	06423
V50	2.0	07>13	145	1 x	06416
V50	2.0 D	07>10	136	1 x	06423
V50	2.0 Flexfuel	07>	145	1 x	06423