



RUOTE WHEELS

CATENE DA NEVE	608	SNOW CHAINS
AUTOSOCK	625	AUTOSOCK
SNOWGECKO	628	SNOWGECKO
COPRICERCHI	629	WHEEL COVERS
ESTETICA RUOTE	638	WHEEL LOOK
ANTIFURTI RUOTE	644	ANTI-THEFT DEVICES FOR WHEELS
DISTANZIALI RUOTA	653	WHEEL SPACERS
BULLONERIA	655	BOLTS
DISTINTA APPLICAZIONE	656	FITTING CHART
KIT RUOTINO DI SCORTA	682	COMPACT SPARE WHEEL KIT

Catene da neve

Catene da neve costruite a regola d'arte e certificate, in ottemperanza al decreto 10 Maggio 2011, (Ministero delle infrastrutture e dei Trasporti, Gazzetta Ufficiale N. 185 del 10 Agosto 2011).

Dispositivi di aderenza supplementare omologati secondo le norme **ÖNORM V5117**

L'acciaio, gli spessori, la cementazione e tutti i processi produttivi sono garantiti da sistemi aziendali con processi di gestione e controllo qualità certificati ISO 9001 da oltre 10 anni.



Numero di omologazione stampigliato sulla piastrina, facilmente ispezionabile e leggibile dalle autorità anche con catena montata



In Europa non esiste una normativa unica che regola l'utilizzo delle catene da neve, infatti ogni singolo stato ha una propria legislazione in materia. Pertanto negli stati europei si possono verificare le seguenti situazioni:

- obbligo di catene a bordo
- obbligo di catene a bordo per i residenti, nessun obbligo di catene a bordo per i turisti
- nessun obbligo di catene a bordo

Si consiglia comunque, prima di iniziare un viaggio, di reperire le opportune informazioni sul paese di destinazione (e dei paesi di transito).

In ogni caso, per fugare ogni dubbio, per la propria sicurezza e per quella degli altri, tenere sempre le catene a bordo nei periodi invernali.

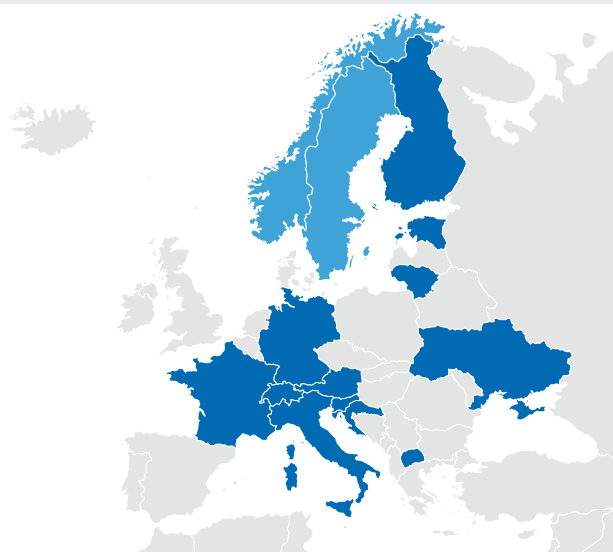

	CATENE DA NEVE					
	RX-7	NX-7	R-9	R-12	S-16	S-12
Facilità di montaggio	**	**	**	**	**	**
Ingombro interno massimo	7 mm	7 mm	9 mm	12 mm	16 mm	12 mm
Compatibile ABS-ESP	●	●	●	●	●	●
Blocca-catenino in plastica composita	●	●	●	●	-	●
Cavo interno flessibile	●	●	●	●	●	●
Auto-Tensionamento	●	●	●	●	●	●
Materiale Battistrada	Acciaio al manganese	Acciaio al manganese	Acciaio cementato	Acciaio cementato	Acciaio cementato	Acciaio cementato
Battistrada	Rombo	Rombo	Rombo	Rombo	Rombo	Rombo + rinforzo
Sezione filo catena	3 mm	3 mm	3 x 2,5 mm	3,5 x 3,5 mm	4,3 x 4,3 mm	3,5 x 3,5 mm
Omologato per obbligo "catene a bordo"	●	●	●	●	●	●



Ogni confezione contiene:

- Libretto plastificato con le istruzioni di montaggio
- Maglie di ricambio
- Guanti in plastica
- Certificato di omologazione

Each box contains:

- Plastic-coated instruction manual
- Spare links for repair
- PE gloves
- Copy of approval certificates.



Imballo da 3 serie

Imballo da 1 serie



In caso di smarrimento della confezione, è possibile risalire alla misura della catena leggendo le cifre stampate sul gancio verde (togliere lo zero dal codice stampigliato; esempio: 80 corrisponde alla misura 8)

In absence of box or label size of the chain can easily be identified by reading the number stamped on the green hook (remove the zero from the code; example number "80" correspond to size "8").

**CATENE DA NEVE A MAGLIA SPECIALE,
7 MM DI INGOMBRO INTERNO**
ideale per tutte le vetture con problema di
catenabilità

ACCIAIO AL MANGANESE

Per una maggiore resistenza all'usura

SNOW CHAINS WITH SPECIAL TWISTED LINKS

7 mm ultra-slim fit.

Special series for vehicles with chain restrictions

MANGANESE STEEL

for extra wear and tear resistance

Valigetta / Case 3

RX-7

MANGANESE



MAGLIA RITORTA - TWISTED LINKS

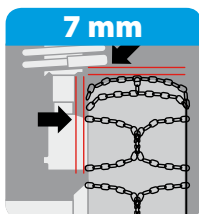

**MONTAGGIO FACILE E VELOCE
QUICK AND EASY FITTING**



SISTEMA DI AUTO-TENSIONAMENTO

- Dopo il montaggio ed il tensionamento manuale, la catena può tendersi ulteriormente in modo automatico evitando ulteriori fermate durante la guida.
- Battistrada in acciaio cementato speciale.
- Maglie ritorte ad alta resistenza.
- Cavo interno flessibile per un montaggio facile, senza sollevare la vettura.
- Cricchetto e ganci di rinvio in resina composita ideale per non graffiare i cerchi in lega.

SELF-TENSIONING SYSTEM

- After the installation and the first manual tensioning, the chains tighten automatically while driving.
- No more stops for tensioning.
- Hardened special alloy steel.
- Special high resistance twisted-links.
- Flexible internal cable for an easy and quick-fit installation, without moving the vehicle.
- New composite plastic tensioning ratchet, ideal for preventing scratches on alloy wheels.

**ACCIAIO AL
MANGANESE
MANGANESE
STEEL**

Omologate a norma di sicurezza



V 5117

CATENE DA NEVE A DOPPIA MAGLIA 7/9 MM

- Esterno ruota: maglia con sezione a "D" da 9 mm
- Interno ruota: maglia ritorta da 7 mm
- Ideale per tutte le vetture con problema di catenabilità

ACCIAIO AL MANGANESE

Per una maggiore resistenza all'usura

SNOW CHAINS WITH DOUBLE LINKS, 7/9 MM

- Inner: 9 mm "D" section link
- Outer: 7 mm twisted link
- Special series for vehicles with chain restrictions

MANGANESE STEEL

for extra wear and tear resistance

Valigetta / Case 3



NX-7

MANGANESE



**MAGLIA INTERNA RITORTA
INTERNAL TWISTED LINKS**

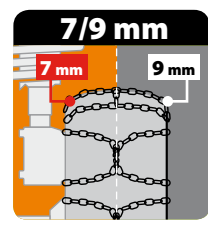

**MONTAGGIO FACILE E VELOCE
QUICK AND EASY FITTING**



SISTEMA DI AUTO-TENSIONAMENTO

- Dopo il montaggio ed il tensionamento manuale, la catena può tendersi ulteriormente in modo automatico evitando ulteriori fermate durante la guida.
- Battistrada in acciaio cementato speciale.
- Maglie ritorte ad alta resistenza.
- Cavo interno flessibile per un montaggio facile, senza sollevare la vettura.
- Cricchetto e ganci di rinvio in resina composita ideale per non graffiare i cerchi in lega.

SELF-TENSIONING SYSTEM

- After the installation and the first manual tensioning, the chains tighten automatically while driving. No more stops for tensioning.
- Hardened special alloy steel.
- Special high resistance twisted-links.
- Flexible internal cable for an easy and quick-fit installation, without moving the vehicle.
- New composite plastic tensioning ratchet, ideal for preventing scratches on alloy wheels.

**ACCIAIO AL MANGANESE
MANGANESE STEEL**

Omologate a norma di sicurezza



V 5117

**CATENE DA NEVE A MAGLIA COMPATTA,
9 MM DI INGOMBRO INTERNO**

Ideale per tutte le vetture con spazio limitato tra pneumatico e parti meccaniche

SNOW CHAINS, QUICK AND EASY FITTING

9 mm slim fit cable links, specific for cars with limited gap between tire and mechanical parts.

Valigetta / Case  3

R-9

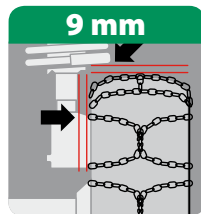

**MONTAGGIO
FACILE E VELOCE
QUICK AND EASY
FITTING**

Omologate a norma di sicurezza



 V 5117

SISTEMA DI AUTO-TENSIONAMENTO

- Dopo il montaggio ed il tensionamento manuale, la catena può tendersi ulteriormente in modo automatico evitando ulteriori fermate durante la guida.
- Battistrada a rombo in acciaio cementato speciale.
- Maglie corte con sezione a "D" utilizzabili da entrambe le parti.
- Cavo interno flessibile per un montaggio facile senza sollevare e spostare la vettura.
- Nuovo blocca-catenino in plastica composita ideale per cerchi in lega.

SELF-TENSIONING SYSTEM

- After the installation and the first manual tensioning, the chains tighten automatically while driving. No more stops for tensioning.
- Hardened special alloy steel with diamond pattern grip.
- Flexible internal cable for an easy and quick installation without moving or lifting the car.
- New composite plastic ratchet, ideal for alloy rims

**CATENE DA NEVE A MAGLIA STANDARD,
12 MM DI INGOMBRO INTERNO**

Sezione standard, alta resistenza, consigliata per tutte le vetture senza particolari limitazioni di ingombro tra pneumatico e parti meccaniche.

SNOW CHAINS, 12 MM EXTRA-STRONG LINKS
Specific for cars with standard gap between tire and mechanical parts.

Valigetta / Case 3

R-12

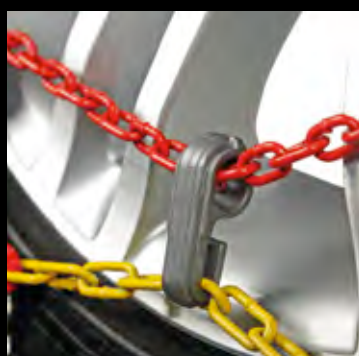
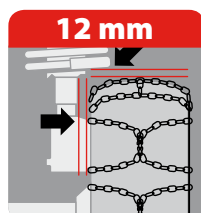

SISTEMA DI AUTO-TENSIONAMENTO

- Dopo il montaggio ed il tensionamento manuale, la catena può tendersi ulteriormente in modo automatico evitando ulteriori fermate durante la guida.
- Battistrada a rombo in acciaio cementato speciale.
- Maglie corte con sezione a "D" utilizzabili da entrambe le parti.
- Cavo interno flessibile per un montaggio facile senza sollevare e spostare la vettura.
- Nuovo blocca-catenino in plastica composita ideale per cerchi in lega.

SELF-TENSIONING SYSTEM

- After the installation and the first manual tensioning, the chains tighten automatically while driving. No more stops for tensioning.
- Hardened special alloy steel with diamond pattern grip.
- Flexible internal cable for an easy and quick installation without moving or lifting the car.
- New composite plastic ratchet, ideal for alloy rims

**MONTAGGIO
FACILE E VELOCE
QUICK AND EASY
FITTING**

Omologate a norma di sicurezza



V 5117

Tabella applicativa • Fitting guide

GR.											COD. ART.			
	10"	12"	13"	14"	15"	16"	17"	18"	19"	20"	RX-7	NX-7	R-9	R-12
1	120/80-10	120/80-12	125-13											
	145/80-10	125/80-12	135/70-13										16061	16021
	145-10	125-12	145/60-13											
	155/80-10	130/80-12												
	155-10	135/80-12												
	165/70-10	135-12												
	500-10	140/70-12												
	145/70-12													
	150/65-12													
	400-12													
2		140-12	135/80-13										16062	16022
		145/80-12	135-13											
		145-12	145/65-13											
		150-12	145/70-13											
		155/70-12	155/60-13											
		165/60-12	155/65-13											
		500-12	165/55-13											
		165/60-13												
		175/50-13												
3		155/80-12	145/80-13	135/80-14	135/70-15								16063	16023
		155-12	145-13	135-14	165/50-15									
		165/70-12	155/70-13	145/70-14										
		175/70-12	165/65-13	155/60-14										
		560-12	175/60-13	155/65-14										
		600-12	185/55-13	165/55-14										
				165/60-14										
			175/50-14											
4			155/80-13	145/80-14	125-15								16065	16024
			155-13	145-14	135-15									
			165/70-13	155/70-14	145/65-15									
			175/65-13	165/65-14	165/55-15									
			185/60-13											
			195/55-13											
4.5				175/60-14	155/65-15								16066	16033
				185/55-14	175/50-15									
					185/50-15									
5			165/80-13	155/80-14	145-15								16067	16025
			165-13	155-14	155/70-15									
			170-13	165/70-14	165/60-15									
			175/70-13	175/65-14	165/65-15									
			185/65-13	185/60-14	170/60-15									
			195/60-13	195/55-14	175/55-15									
			560-13	520-14	195/45-15									
		590-13	560-14											
6			175/75-13	165/75-14	155-15	165/55-16					16383	15980	16068	16026
			175/80-13	165/80-14	165/70-15	175/55-16								
			175-13	165-14	175/60-15	185/50-16								
			185/70-13	175/70-14	175/65-15	195/45-16								
			195/65-13	185/65-14	185/55-15	205/40-16								
			205/60-13	195/60-14	195/50-15									
		640-13		560-15										
6.5				175/75-14	185/60-15	175/50-16					16384	15981	16069	16034
				185/70-14	195/55-15	175/60-16								
				205/55-14	205/50-15	185/55-16								
						Pirelli Winter 205/45-16 215/40-16								
7			195/70-13	175/80-14	175/70-15	195/50-16	205/40-17				16385	15982	16070	16027
			600-13	175-14	185/65-15									
				195/65-14	195/60-15									
				205/60-14										
7.5					205/55-15	185/55-16	225/35-17				16386	15983	16071	
					215/50-15	No Pirelli Winter 185/60-16								
						205/50-16 215/45-16								

Tabella applicativa • Fitting guide

GR.	10"	12"	13"	14"	15"	16"	17"	18"	19"	20"	COD. ART.				
											RX-7	NX-7	R-9	R-12	
8			205/70-13	185/80-14 185-14 195/70-14 205/65-14 225/55-14	185/70-15 195/65-15 205/60-15	195/55-16 195/60-16 No Michelin Alpine	205/45-17 215/40-17					16387	15984	16072	16028
8.5				225/60-14	225/50-15	225/45-16		205/40-18				16388	15985	16073	
9				195/80-14 195-14 205/70-14 600-14	180-15 185-15 195/70-15 205/65-15 215/60-15 225/55-15	195/60-16 Michelin Alpine 195/65-16 205/55-16 215/50-16	195/55-17 205/50-17 215/45-17 235/40-17	225/35-18				16389	15986	16074	16029
9.5				235/60-14	195/75-15 205/70-15 215/65-15 225/60-15 235/55-15	205/60-16 215/55-16 225/50-16	215/50-17 No Kleber Krisalp 225/45-17	215/40-18				16390	15987	16075	16037
9.7						195/70-16 205/65-16 215/60-16 No Continental Premium Contact 2 / No Michelin Primacy Energy Saver / No Bridgestone Duravis Rxxx	205/55-17 245/40-17	215/45-18 225/40-18 245/35-18				16391	15988	16081	
10				205/80-14 205-14 215/70-14 215-14	195/80-15 195-15 215/70-15 225/65-15 235/60-15 600-15 890-15	215/60-16 Continental Premium Contact 2 / Michelin Primacy Energy Saver / Bridgestone Duravis Rxxx 225/55-16 235/50-16 245/45-16	215/50-17 Kleber Krisalp 215/55-17 225/50-17 235/45-17	225/45-18 235/40-18	235/35-19			16392	15989	16076	16030
12						215/65-16 225/60-16	235/50-17 245/45-17 255/40-17 265/40-17	215/50-18 235/45-18 245/40-18 255/35-18	225/40-19 235/40-19 245/35-19 255/30-19			16393	15992	16078	16039
12.5						215/70-16	215/60-17 225/55-17	215/55-18 275/35-18	245/40-19			16394	15993	16082	
13					235/70-15	235/60-16 245/55-16	215/65-17 225/60-17 235/55-17 255/45-17 275/40-17	225/50-18 225/55-18 245/45-18 255/40-18 255/45-18 295/30-18	205/55-19 225/45-19 235/45-19 255/35-19 265/35-19 275/30-19	195/55-20 245/35-20 265/30-20		16395	15994	16079	16040
14						225/70-16 235/70-16	225/65-17 235/60-17 245/55-17	225/60-18 235/55-18 245/50-18	225/55-19 245/45-19	245/40-20 265/35-20 285/30-20				16080	

Catena composta da 6 croci - Chain equipped with 6 crosses

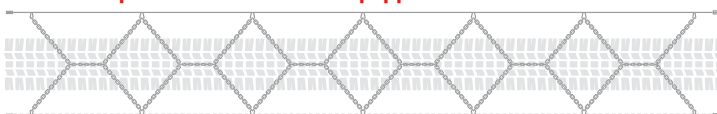

R-12

Tutti i gruppi
All groups

RX-7 NX-7 R-9

Gr. 1 - 2 - 3 - 4 - 4.5 - 5 - 6 - 7 - 7.5

Catena composta da 8 croci - Chain equipped with 8 crosses

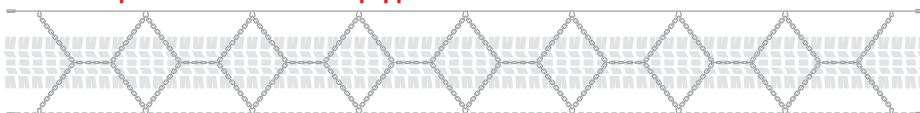

RX-7 NX-7 R-9

Gr. 8 - 8.5 - 9 - 9.5 - 9.7 - 10 - 12 - 12.5 - 13 - 14

**COPPIA CATENE DA NEVE
PER SUV, 4X4, FUORISTRADA**

12 mm di ingombro, per veicoli con spazio ridotto tra passaruota, organi di trasmissione, sospensioni, sistemi frenanti e pneumatico.

**PAIR OF SNOW CHAINS FOR SUV, 4X4,
AND OFF-ROAD VEHICLES**

12 mm width, suitable for vehicles with reduced space between mudguard, transmission system, suspensions, brake system and tire.

Valigetta / Case 1

S-12

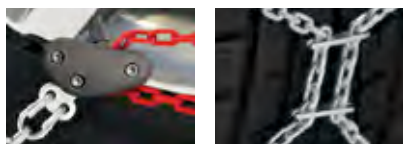

**Blocca-catenino in
plastica composita
New composite
plastic ratchet**

**Doppio rinforzo
centrale
Double central
reinforcement**

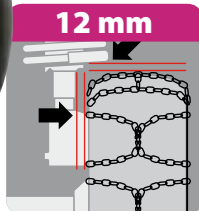

**MONTAGGIO FACILE E VELOCE
QUICK AND EASY FITTING**



**QUALITÀ GARANTITA, OMOLOGATE
DAL TÜV AUSTRIA E Ö-NORM AUSTRIACO**

- 12 mm di ingombro interno.
- Doppio rinforzo centrale per una miglior aderenza.
- Sistema di auto-tensionamento.
- Maglie esterne di regolazione.
- Battistrada a rombo in acciaio cementato.
- Maglie corte con sezione a "D" utilizzabili da entrambe le parti.
- Cavo interno flessibile per un montaggio facile.
- Blocca-catenino in plastica composita ideale per cerchi in lega.
- Guanti di protezione e maglie di riparazione in dotazione.

TÜV AUSTRIA AND Ö-NORM APPROVED QUALITY

- 12 mm slim-fit cable links.
- New self-tensioning system.
- External links for extra adjustments.
- Hardened special alloy steel with diamond pattern grip.
- Short D-section links usable on both sides.
- Flexible internal cable for an easy and quick installation.
- New composite plastic ratchet, ideal for alloy rims.
- Protection gloves and spare links included.

Omologate
a norma di
sicurezza



COPPIA CATENE DA NEVE PER FURGONI, SUV, FUORISTRADA, CAMPER

Con filo maggiorato da 4,3 mm per pneumatici uso pesante.

PAIR OF SNOW CHAINS FOR SUV, VANS AND OFFROAD

Chains with 4,3 mm wire for heavy duty tires.

Valigetta / Case  1

S-16



2
pcs

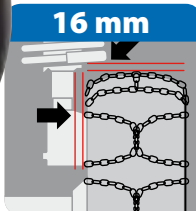

**MONTAGGIO FACILE E VELOCE
QUICK AND EASY FITTING**



**QUALITÀ GARANTITA, OMOLOGATE
DAL TÜV AUSTRIA E Ö-NORM AUSTRIACO**

- 16 mm di ingombro interno.
- Montaggio facile e rapido senza muovere il veicolo.
- Maglie compatte con sezione "D".
- Catena laterale zincata e plastificata.
- Cavo interno flessibile plastificato con aggancio rapido.
- Aggancio esterno con blocca-catenino.
- Tirante con tensionamento automatico.
- Guanti di protezione e maglie di riparazione in dotazione.

**TÜV AUSTRIA AND Ö-NORM
APPROVED QUALITY**

- 16 mm chain width.
- Quick and easy installation without moving the car.
- "D" section compact links.
- Zincated and plastic-coated side chain.
- Plasticized flexible internal wire with quick-fitting.
- External fitting with chain-block.
- Self-tensioning ratchet.
- Protection gloves and spare links included.

Omologate
a norma di
sicurezza



 V 5117

Tabella applicativa • Fitting guide

GR.	12"	13"	14"	15" 15.3"	16" 16.5"	17" 17.5"	18"	19" 19.5"	20"	21"	COD. ART.		
											S-12	S-16	
19			165/75-14 165/80-14 165-14 175/75-14 185/65-14									16101	
20			175/80-14 175-14 185/70-14 650-14									16102	
20.5	24x8.5-12	6.70-13	24x8.5-14									16116	
21			185/75-14 185/80-14 185-14 195/70-14 200-14 205/65-14 215/65-14 700-14	165-15 175/80-15 195/65-15 640-15							16460	16103	
22			195/75-14 195/80-14 195-14 205/70-14 215/70-14 25x8.5-14 670-14	185/80-15 185-15 195/70-15 205/65-15	175/75-16 175/80-16 175-16 195/65-16 200/70-16						16461	16104	
22.5			205/75-14 205/80-14 205-14	195/75-15 195/80-15 195-15 205/70-15 205/75-15 215/65-15	185/75-16 195/70-16 195/75-16 Kleber TransPro / Michelin Agilis Alpin Continental Vanco2 205/65-16 215/60-16 No Continental Premium Contact 2 No Michelin Primacy Energy Saver No Bridgestone Duravis Rxxx						16462	16105	
22.7				215/70-15	195/75-16 No Kleber TransPro / No Michelin Agilis Alpin / No Continental Vanco2 215/60-16 Continental Premium Contact 2 / Michelin Primacy Energy Saver / Bridgestone Duravis Rxxx	215/55-17 225/50-17						16463	16128
23			215/75-14 215/80-14 215-14 750-14	205/80-15 215/75-15 225/70-15 670-15	185/80-16 185-16 195/80-16 195-16 215/65-16 225/60-16 600-16 640-16	225/55-17		225/40-19			16464	16106	
23.5					205/75-16 215/70-16 225/65-16 235/60-16	205/65-17 215/60-17 215/65-17	215/55-18 245/45-18	225/45-19				16465	16127
24				215/80-15 215-15 225/75-15 235/70-15 255/60-15 700-15	205/80-16 205-16 215/75-16 225/70-16 235/65-16 Continental Vanco 255/40-16 650-16	225/60-17 235/55-17 205/65-17.5 7.0-17.5	225/55-18 235/50-18 255/45-18	235/45-19 255/40-19			16466	16107	
24.5				235/75-15 28x9-15	215/80-16 215/85-16 215-16 225/75-16 235/65-16 No Continental Vanco 650-16.5	225/65-17 235/60-17 650-17	225/60-18 235/55-18 245/50-18	245/45-19 255/45-19	245/40-20		16467	16108	

Tabella applicativa • Fitting guide

GR.	12"	13"	14"	15" 15.3"	16" 16.5"	17" 17.5"	18"	19" 19.5"	20"	21"	COD. ART.	
											S-12	S-16
24.6	27x8.5-12			27x8.5-15 8.15-15 S.E.								16117
24.7				255/70-15 30x9.50-15 8.40-15	235/70-16 255/65-16	225/70-17 235/65-17 255/55-17 205/75-17.5	235/60-18	225/55-19 235/50-19 275/40-19	235/45-20 255/40-20 275/35-20		16468	16110
24.8				250/70-15 250-15 700-15								16118
25				265/70-15 750-15 9.0-15	235/75-16 235/80-16 245/70-16 255/65-16 700-16 9.0x75-16	235/70-17 245/65-17 215/75-17.5 8-17.5	225/65-18 245/60-18	235/55-19 245/50-19	245/45-20		16469	16109
25.5				10.0-15 255/75-15 265/75-15 31x10.5-15	245/75-16 255/70-16	245/70-17 255/60-17 255/65-17 275/55-17	235/65-18 255/55-18 285/50-18	245/55-19 255/50-19 275/45-19	235/55-20 245/50-20 255/45-20 275/40-20		16470	16111
25.8	10x80-12			270/75-15 Nokian TRI-2 10.0x75-15.3	250/75-16 Nokian TRI-2 250/80-16 No Nokian TRI-2 260/70-16 10.0-16.5							16119
26					750-16 9.5-16.5	225/75-17.5 8.5-17.5		7.0-19.5				16112
26.3				29x12.5-15 29x12-15	315/55-16							16120
26.4				29x13.5-15								16121
26.5				31x11.5-15	235/85-16 265/70-16 280/70-16	265/65-17 275/60-17	255/60-18 265/60-18	255/55-19 265/50-19 285/45-19	255/50-20 265/45-20 275/45-20 295/40-20 315/35-20	265/40-21 265/45-21 295/35-21	16471	16113
26.7				32x11.5-15	265/75-16 275/70-16	245/75-17 265/70-17 275/65-17	265/65-18 275/60-18 285/55-18	265/55-19	265/50-20		16472	16122
26.8				31x15.5-15								16123
27				825-15	250/80-16 Nokian TRI-2 825-16	9.5-17 235/75-17.5 245/70-17.5 245/75-17.5 9.5-17.5	750-18	8-19.5	650-20 700-20		16473	16114
27.3					250/80-16							16124
27.4						285/70-17 10.0-17.5 265/70-17.5	250/80-18 275/65-18 285/65-18	245/70-19.5	275/55-20			16125
27.5					295/75-16			265/70-19.5	260/70-20			16115
27.7							10.5-18 10.5x80-18 275/80-18		280/70-20 9.5-20			16126



Tabella applicazione su 2 lati
Fitting guide on both sides



99199

POSTER CATENE CON TELAIO
SNOW CHAINS POSTER WITH STAND
cm 58x160

99076

ESPOSITORE CATENE (FORNITO SMONTATO)
Per 44 valigette auto o 40 valigette furgone
DISPLAY RACK
Holds 44 boxes (car-chains) or 40 boxes (van-chains)

Cartone / Carton 1

**CATENE DA NEVE A MAGLIA COMPATTA,
9 MM DI INGOMBRO INTERNO**

Ideale per tutte le vetture con spazio limitato tra pneumatico e parti meccaniche

SNOW CHAINS, QUICK AND EASY FITTING

9 mm slim fit cable links, specific for cars with limited gap between tire and mechanical parts.

Valigetta / Case  4



WX-9

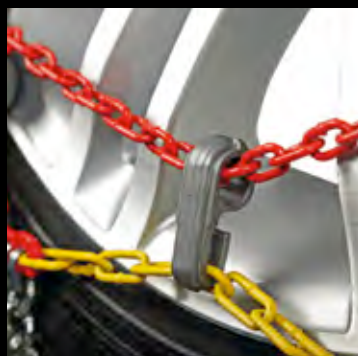
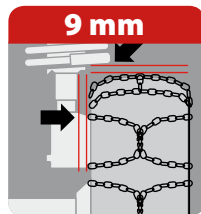

SISTEMA DI AUTO-TENSIONAMENTO

- Dopo il montaggio ed il tensionamento manuale, la catena può tendersi ulteriormente in modo automatico evitando ulteriori fermate durante la guida.
- Battistrada a rombo in acciaio cementato speciale.
- Maglie corte con sezione a "D" utilizzabili da entrambe le parti.
- Cavo interno flessibile per un montaggio facile senza sollevare e spostare la vettura.
- Nuovo blocca-catenino in plastica composita ideale per cerchi in lega.

SELF-TENSIONING SYSTEM

- After the installation and the first manual tensioning, the chains tighten automatically while driving. No more stops for tensioning.
- Hardened special alloy steel with diamond pattern grip.
- Flexible internal cable for an easy and quick installation without moving or lifting the car.
- New composite plastic ratchet, ideal for alloy rims

**MONTAGGIO
FACILE E VELOCE
QUICK AND EASY
FITTING**

Omologate a norma di sicurezza



 V 5117

Tabella applicativa • Fitting guide

GR.	10"	12"	13"	14"	15"	16"	17"	18"	19"	20"	COD. ART.
											WX-9
1	120/80-10	120/80-12	125-13								GD02001
	145/80-10	125/80-12	135/70-13								
	145-10	125-12	145/60-13								
	155/80-10	130/80-12									
	155-10	135/80-12									
	165/70-10	135-12									
	500-10	140/70-12									
	145/70-12										
	150/65-12										
	400-12										
2		140-12	135/80-13								GD02002
		145/80-12	135-13								
		145-12	145/65-13								
		150-12	145/70-13								
		155/70-12	155/60-13								
		165/60-12	155/65-13								
		500-12	165/55-13								
			165/60-13								
		175/50-13									
3		155/80-12	145/80-13	135/80-14	135/70-15						GD02003
		155-12	145-13	135-14	165/50-15						
		165/70-12	155/70-13	145/70-14							
		175/70-12	165/65-13	155/60-14							
		560-12	175/60-13	155/65-14							
		600-12	185/55-13	165/55-14							
				165/60-14							
			175/50-14								
4			155/80-13	145/80-14	125-15						GD02005
			155-13	145-14	135-15						
			165/70-13	155/70-14	145/65-15						
			175/65-13	165/65-14	165/55-15						
			185/60-13								
			195/55-13								
4.5				175/60-14	155/65-15						GD02006
				185/55-14	175/50-15						
5			165/80-13	155/80-14	145-15						GD02007
			165-13	155-14	155/70-15						
			170-13	165/70-14	165/60-15						
			175/70-13	175/65-14	165/65-15						
			185/65-13	185/60-14	170/60-15						
			195/60-13	195/55-14	175/55-15						
			560-13	520-14	195/45-15						
			590-13	560-14							
6			175/75-13	165/75-14	155-15	165/55-16					GD02009
			175/80-13	165/80-14	165/70-15	175/55-16					
			175-13	165-14	175/60-15	185/50-16					
			185/70-13	175/70-14	175/65-15	195/45-16					
			195/65-13	185/65-14	185/55-15	205/40-16					
			205/60-13	195/60-14	195/50-15						
			640-13		560-15						
6.5				175/75-14	185/60-15	175/50-16					GD02010
				185/70-14	195/55-15	175/60-16					
				205/55-14	205/50-15	185/55-16					
						Pirelli Winter 205/45-16 215/40-16					
7			195/70-13	175/80-14	175/70-15	195/50-16	205/40-17				GD02011
			600-13	175-14	185/65-15						
				195/65-14	195/60-15						
				205/60-14							
7.5					205/55-15	185/55-16	225/35-17				GD02012
					215/50-15	No Pirelli Winter 185/60-16 205/50-16 215/45-16					

Tabella applicativa • Fitting guide

GR.	10"	12"	13"	14"	15"	16"	17"	18"	19"	20"	COD. ART.
											WX-9
8			205/70-13	185/80-14 185-14 195/70-14 205/65-14 225/55-14	185/70-15 195/65-15 205/60-15	195/55-16 195/60-16 No Michelin Alpine	205/45-17 215/40-17				GD02013
8.5				225/60-14	225/50-15	225/45-16		205/40-18			GD02014
9				195/80-14 195-14 205/70-14 600-14	180-15 185-15 195/70-15 205/65-15 215/60-15 225/55-15	195/60-16 Michelin Alpine 195/65-16 205/55-16 215/50-16	195/55-17 205/50-17 215/45-17 235/40-17	225/35-18			GD02015
9.5				235/60-14	195/75-15 205/70-15 215/65-15 225/60-15 235/55-15	205/60-16 215/55-16 225/50-16	215/50-17 No Kleber Krisalp 225/45-17	215/40-18			GD02016
9.7						195/70-16 205/65-16 215/60-16 No Continental Premium Contact 2 / No Michelin Primacy Energy Saver / No Bridgestone Duravis Rxxx	205/55-17 245/40-17	215/45-18 225/40-18 245/35-18			GD02017
10				205/80-14 205-14 215/70-14 215-14	195/80-15 195-15 215/70-15 225/65-15 235/60-15 600-15 890-15	215/60-16 Continental Premium Contact 2 / Michelin Primacy Energy Saver / Bridgestone Duravis Rxxx 225/55-16 235/50-16 245/45-16	215/50-17 Kleber Krisalp 215/55-17 225/50-17 235/45-17	225/45-18 235/40-18	235/35-19		GD02018
12						215/65-16 225/60-16	235/50-17 245/45-17 255/40-17 265/40-17	215/50-18 235/45-18 245/40-18 255/35-18	225/40-19 235/40-19 245/35-19 255/30-19		GD02019
12.5						215/70-16	215/60-17 225/55-17	215/55-18 275/35-18	245/40-19		GD02020
13					235/70-15	235/60-16 245/55-16	215/65-17 225/60-17 235/55-17 255/45-17 275/40-17	225/50-18 225/55-18 No Continental 245/45-18 255/40-18 265/35-19 255/45-18 295/30-18	205/55-19 225/45-19 235/45-19 255/35-19 265/35-19 275/30-19	195/55-20 245/35-20 265/30-20	GD02021
14						225/70-16 235/70-16	225/65-17 235/60-17 245/55-17	225/60-18 235/55-18 245/50-18	225/55-19 245/45-19	245/40-20 265/35-20 285/30-20	GD02022

Catena composta da 6 croci - Chain equipped with 6 crosses

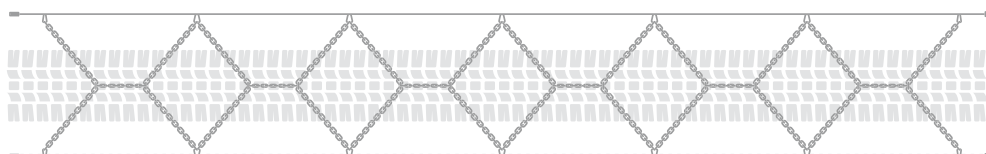

Tutti i gruppi
All groups



**SCAFFALE
CON VISTA FRONTALE**
Composto dagli art.
99265 + N98995 + 99271 + 99271



**ESPOSITORE
CON VISTA LATERALE**
Art. 99076



NUOVA CONFEZIONE
in valigetta di facile apertura e chiusura,
dotata di apertura intelligente per un facile
inserimento delle catene dopo l'utilizzo



Scatola chiusa con **sigillo di garanzia** a conferma che la
confezione è integra
e non è mai stata aperta



Nuova grafica, con misura ripetuta su 3 lati, idonea per esposizione su scaffale con vista dal fronte oppure su espositore con vista laterale

FRONTE



LATO



RETRO



LA SOLUZIONE PER LA TRAZIONE INVERNALE



UTILIZZABILI PER L'OSSERVANZA DELL'OBBLIGO CATENE A BORDO

La sentenza del Tribunale Amministrativo Regionale per il Lazio (Roma) del 28 giugno 2013 ha confermato che gli automobilisti possono utilizzare le catene in tessuto AutoSock® in presenza del segnale di obbligo di avere catene neve o in alternativa pneumatici invernali montati.



ÖNorm V 5121: 2007
PPP 53219: 2000
DIN 31000: 1979

L'UNICA ORIGINALE E BREVETTATA

AutoSock® è protetto da brevetto Europeo No. 1.165.329
The AutoSock® product is protected by European patent No. 1.165.329

AutoSock è un tipo di dispositivo antiscivolo che mira ad aumentare l'attrito delle ruote su strade innevate e con presenza di ghiaccio:

- **approvato dagli enti di certificazione TÜV SÜD, GS e Ö-NORM**
- **approvato ed omologato TÜV**
- **approvato dalle maggiori case automobilistiche**
- **facile e veloce da montare e rimuovere anche in condizioni meteo avverse.**
- leggero e facile da riporre.
- comodo durante la guida, non provoca vibrazioni o rumori
- si centra da solo
- riutilizzabile e lavabile in lavatrice
- riciclabile ed ecologico, non reca danni all'ambiente
- non danneggia i cerchi
- adatto a tutti i veicoli con poco spazio tra ruota, carrozzeria ed impianto frenante
- incrementa l'efficienza dei sistemi elettronici di sicurezza (ABS, ESP, ETS, ASR, DSC)



VELOCE, PRATICO E SOPRATTUTTO SICURO.

Le qualità di Autosock sono garantite oltre che dalle certificazioni anche da numerosi riconoscimenti e premi internazionali



IDEALE PER LE VETTURE MODERNE

AutoSock è adatto per tutti i veicoli con poco spazio tra la ruota, le parti meccaniche e la carrozzeria.



STANDARD

Adatta per la vetture con pneumatici di dimensioni normali

Busta / Bag 12



HIGH PERFORMANCE

Adatta per le vetture equipaggiate con pneumatici a sezione larga e per SUV, 4x4, Furgoni, Camper...

Busta / Bag 12

99070

Espositore da banco 6 coppie

COPRE L'80% DELLA QUOTA DI MERCATO AUTO

Assortimento consigliato:

- 1 misura 645
- 1 misura 695
- 1 misura 697
- 1 misura 830
- 1 misura 850
- 1 misura 870



Espositori forniti vuoti

99071

Espositore per punto vendita 18 coppie

COPRE IL 100% DELLA QUOTA DI MERCATO (tutte le misure di pneumatici)

Assortimento consigliato:

- 1 misura 54 / 540
- 2 misura 58 / 600
- 1 misura 62 / 600
- 1 misura 605
- 1 misura 620 / 600
- 1 misura 625
- 2 misura 645
- 1 misura 665
- 1 misura 685
- 1 misura 695
- 1 misura 697
- 1 misura 698
- 1 misura 699
- 1 misura 830
- 1 misura 850
- 1 misura 870



Espositori forniti vuoti

GR.	MISURE PNEUMATICI / TIRE SIZES											STANDARD
	12"	13"	14"	15"	16"	17"	18"	19"	20"	21"	22"	
54	155/80-12	145/80-13	155/65-14	155/60-15								105401010
	155-12	155/70-13	165/55-14	165/50-15								
		155/80-13	165/60-14	165/55-15								
		165/65-13	165/65-14	165/60-15								
		165/70-13	175/60-14	185/50-15								
		175/65-13	185/55-14	195/45-15								
		185/60-13										
		195/55-13										
58		165/80-13	165/70-14	165/70-15	175/60-16							105801010
		165-13	175/65-14	175/55-15	185/50-16							
		175/70-13	175/70-14	175/60-15	195/45-16							
		175/75-13	185/60-14	185/55-15	195/50-16							
		185/65-13	185/65-14	185/60-15								
		185/70-13	195/55-14	195/50-15								
		195/65-13	195/60-14	195/55-15								
		195/70-13	205/55-14	205/60-14								
62		175-13	185/70-14	175/65-15	185/55-16							106200810
		205/70-13	195/65-14	185/65-15	195/55-16							
				195/60-15								

GR.	MISURE PNEUMATICI / TIRE SIZES											HIGH PERFORMANCE		
	12"	13"	14"	15"	16"	17"	18"	19"	20"	21"	22"			
540	155/70-12	135/80-13	135-14	125/80-15	135/55-16							305401080		
	155/80-12	135-13	145/70-14	135/70-15	195/40-16									
	155-12	145/80-13	155/65-14	145/65-15										
		145-13	155/70-14	155/55-15										
		155/65-13	165/55-14	155/60-15										
		155/70-13	165/60-14	165/50-15										
		165/65-13	165/65-14	165/55-15										
		165/70-13	175/50-14	165/60-15										
		175/60-13	175/60-14	175/50-15										
		175/65-13	185/50-14	185/45-15										
		185/60-13	185/55-14	185/50-15										
		195/55-13	195/45-14	195/45-15										
		195/60-13												
		215/50-13												
	600		155/80-13	155-14	145/80-15	165/55-16	195/40-17	205/35-18						305800880
			155-13	165/70-14	155/70-15	175/55-16	195/45-17							
		160-13	165/75-14	165/65-15	175/60-16	205/40-17								
		165/80-13	165/80-14	165/70-15	185/50-16	215/35-17								
		165-13	175/65-14	175/55-15	185/55-16	215/40-17								
		175/70-13	175/70-14	175/60-15	195/45-16	225/30-17								
		175/75-13	175/75-14	175/65-15	195/50-16	225/35-17								
		175/80-13	185/60-14	180/60-15	195/55-16									
		175-13	185/65-14	185/55-15	205/40-16									
		185/65-13	185/70-14	185/60-15	205/45-16									
		185/70-13	195/55-14	185/65-15	205/50-16									
		195/65-13	195/60-14	195/50-15	215/40-16									
		195/70-13	195/65-14	195/55-15	215/45-16									
		205/60-13	205/55-14	195/60-15	225/40-16									
		205/70-13	205/60-14	205/45-15										
		215/60-13		205/50-15										
	215/65-13		205/55-15											
	225/55-13		215/45-15											
	235/50-13		215/50-15											
605				205/50-15	205/45-16	205/40-17						305850080		
					215/40-16	215/35-17								
					215/45-16	215/40-17								
625					205/50-16	195/45-17	235/35-18					306050080		
						215/45-17								
645		185/80-13	175/80-14	175/70-15	175/70-16	175/65-17	205/40-18	215/35-19				306250080		
		185-13	185/75-14	175/75-15	185/60-16	185/60-17	205/45-18	225/30-19						
		195/75-13	185/80-14	185/70-15	185/65-16	205/45-17	215/35-18	225/35-19						
		225/65-13	185-14	195/65-15	185/65-16	205/50-17	215/40-18	235/30-19						
			195/70-14	195/70-15	195/60-16	205/55-17	215/45-18	245/30-19						
			195/75-14	205/60-15	195/65-16	215/45-17	225/35-18							
			205/65-14	205/65-15	205/55-16	215/50-17	225/40-18							
			205/70-14	215/55-15	205/60-16	225/40-17	235/35-18							
			215/60-14	215/60-15	215/50-16	225/45-17	235/40-18							
			215/65-14	225/55-15	215/55-16	235/40-17	245/35-18							
			225/60-14	235/55-15	225/45-16	235/45-17								
			235/60-14	245/50-15	225/50-16	245/40-17								
					235/45-16									
					245/45-16									

GR.	MISURE PNEUMATICI / TIRE SIZES											HIGH PERFORMANCE
	12"	13"	14"	15"	16"	17"	18"	19"	20"	21"	22"	
665			215/70-14	215/65-15 225/60-15	195/65-16 205/60-16 215/60-16 225/55-16	205/55-17 215/50-17 225/50-17 245/45-17	215/45-18 225/45-18	225/40-19 235/35-19				306350080
685		185/85-13 195-13	195/80-14 195-14 205/75-14 215/70-14 215/75-14 225/65-14 225/70-14 245/60-14	175/80-15 185/75-15 185-15 195/75-15 195/80-15 205/70-15 215/65-15 215/70-15 225/60-15 225/65-15 235/60-15	175/75-16 175/80-16 185/70-16 185/75-16 195/70-16 205/65-16 215/60-16 215/65-16 225/55-16 225/60-16 235/55-16 245/50-16	205/60-17 215/55-17 225/50-17 225/55-17 235/50-17 245/45-17 255/40-17	165/70-18 205/55-18 215/50-18 225/45-18 225/50-18 235/45-18 245/40-18 255/35-18	225/40-19 235/35-19 235/40-19 245/35-19 255/30-19	235/35-20 245/30-20			306500080
695	250/75-12		205/80-14 205-14 215/80-14 225/75-14 235/70-14 245/70-14 255/60-14 265/60-14 275/60-14	195/85-15 205/80-15 215/75-15 225/70-15 235/65-15 245/60-15 245/65-15 255/55-15 255/60-15 265/60-15 275/50-15	195/75-16 205/70-16 205/75-16 215/70-16 225/65-16 235/60-16 245/55-16 245/60-16 255/50-16 255/55-16 265/50-16	195/70-17 205/65-17 215/60-17 225/60-17 235/55-17 245/50-17 245/55-17 255/45-17 255/50-17 275/40-17	215/55-18 225/55-18 235/50-18 245/45-18 245/50-18 255/40-18 255/45-18 265/40-18 265/45-18 275/35-18 275/40-18 285/35-18	225/45-19 225/50-19 235/45-19 245/40-19 245/45-19 255/35-19 255/40-19 265/35-19 265/40-19 275/35-19 285/30-19	195/50-20 215/45-20 225/35-20 235/40-20 245/35-20 245/40-20 255/30-20 255/35-20 265/30-20 265/35-20 275/30-20	255/30-21		306850080
697		270/70-13	255/70-14	215/80-15 215-15 225/75-15 225/80-15 235/70-15 235/75-15 245/70-15 245/75-15 255/65-15 255/70-15 275/60-15	195/85-16 205/80-16 205/85-16 205-16 215/75-16 215/80-16 215-16 225/70-16 225/75-16 235/65-16 235/70-16 235/75-16 245/70-16 255/60-16 255/65-16 265/60-16 275/55-16 275/60-16	205/70-17 205/75-17 215/65-17 215/70-17 215/75-17 225/65-17 225/70-17 235/60-17 235/65-17 245/60-17 245/65-17 255/55-17 255/60-17 265/55-17 275/55-17	215/65-18 225/60-18 225/65-18 235/55-18 235/60-18 245/55-18 245/60-18 255/50-18 255/55-18 265/55-18 275/45-18 275/50-18	205/55-19 215/55-19 225/55-19 225/60-19 235/50-19 235/55-19 245/50-19 245/55-19 255/45-19 255/50-19 265/50-19 275/40-19 285/40-19	225/45-20 225/55-20 235/45-20 245/45-20 245/50-20 255/40-20 255/45-20 265/40-20 265/45-20 275/40-20 285/35-20 285/40-20	245/35-21 245/40-21 245/45-21 255/35-21 255/40-21 265/35-21 265/40-21 275/35-21	265/30-22 265/35-22 265/35-22	307200980
698				245/85-15 255/75-15 265/70-15 265/75-15 275/70-15	215/85-16 225/80-16 225/85-16 235/80-16 235-16 245/75-16 255/70-16 255/75-16 265/65-16 265/70-16 275/65-16 285/60-16	225/75-17 235/75-17 245/70-17 245/75-17 255/65-17 255/70-17 265/60-17 265/65-17 275/60-17 285/60-17	225/70-18 235/65-18 255/60-18 255/65-18 265/60-18 265/65-18 275/55-18 285/55-18	215/65-19 225/65-19 245/55-19 255/55-19 265/55-19 275/45-19 275/50-19	235/55-20 255/50-20 255/55-20 265/50-20 275/45-20 275/50-20 285/45-20 295/40-20	255/50-21 265/45-21 275/40-21 275/45-21 285/40-21	235/45-22 255/40-22 255/45-22 265/40-22 275/40-22 285/35-22	307600980
699				245/85-15	235/85-16 255/75-16 265/75-16 275/70-16 7.5-16	245/75-17 265/70-17 275/65-17 285/60-17	265/65-18 275/60-18 285/55-18	235/65-19 255/60-19 275/55-19	275/50-20	275/45-21 295/40-21	265/40-22 275/40-22 295/35-22	307800980
830			255/55-14	265/50-15 305/50-15		265/40-17 315/35-17	265/35-18 285/40-18 295/30-18 295/35-18	265/30-19 275/30-19 285/35-19 295/30-19 295/35-19 305/30-19	285/30-20 295/30-20 305/25-20	295/25-21		306501888
850					295/50-16	305/45-17	285/50-18 295/45-18	285/45-19 295/40-19	275/35-20 295/35-20 305/30-20 315/30-20 315/35-20	275/30-21 285/30-21 285/35-21 295/30-21 295/35-21 325/30-21	275/35-22 295/25-22 295/30-22 325/25-22	307101888
870				315/70-15	255/80-16 255/85-16 265/75-16 285/75-16 295/75-16 305/70-16	235/80-17 265/70-17 275/70-17.5 285/65-17 285/70-17 295/70-17	255/75-18 265/65-18 275/70-18 285/65-18 305/60-18	235/75-19.5	245/60-20 275/60-20 285/55-20 285/60-20 305/50-20 305/55-20	285/45-21	275/50-22 305/40-22 305/45-22 315/40-22	308101888



SnowGecko è un nuovissimo tipo di dispositivo antiscivolo che mira ad aumentare l'attrito delle ruote su strade innevate e con presenza di ghiaccio:

- approvato dagli enti di certificazione TÜV SÜD, GS e Ö-NORM
- approvato ed omologato TÜV
- approvato dalle maggiori case automobilistiche
- facile e veloce da montare e rimuovere anche in condizioni meteo avverse.
- leggero e facile da riporre.
- comodo durante la guida, non provoca vibrazioni o rumori
- si centra da solo
- riutilizzabile e lavabile in lavatrice
- riciclabile ed ecologico, non reca danni all'ambiente
- non danneggia i cerchi
- per i veicoli con poco spazio tra ruota, carrozzeria ed impianto frenante
- incrementa l'efficienza dei sistemi elettronici di sicurezza (ABS, ESP, ETS, ASR, DSC)

GR.	MISURE PNEUMATICI / TIRE SIZES								SNOWGECKO
	12"	13"	14"	15"	16"	17"	18"	19"	
S	155/70-12	135/80-13	135-14	125/80-15	135/55-16				205400201
	155/80-12	135-13	145/70-14	135/70-15	195/40-16				
	155-12	145/80-13	155/65-14	145/65-15					
		145-13	155/70-14	155/55-15					
		155/65-13	165/55-14	155/60-15					
		155/70-13	165/60-14	165/50-15					
		165/65-13	165/65-14	165/55-15					
		165/70-13	175/50-14	165/60-15					
		175/60-13	175/60-14	175/50-15					
		175/65-13	185/50-14	185/45-15					
		185/60-13	185/55-14	185/50-15					
		195/55-13	195/45-14	195/45-15					
		195/60-13							
		215/50-13							
	M		155/80-13	155/80-14	145/80-15	165/55-16	195/40-17	205/35-18	
		155-13	155-14	155/70-15	175/55-16	195/45-17			
		160-13	165/70-14	165/65-15	175/60-16	205/40-17			
		165/80-13	165/75-14	165/70-15	185/50-16	215/35-17			
		165-13	165/80-14	175/55-15	185/55-16	215/40-17			
		175/70-13	175/65-14	175/60-15	195/45-16	225/30-17			
		175/75-13	175/70-14	175/65-15	195/50-16	225/35-17			
		175/80-13	175/75-14	180/60-15	195/60-15				
		175-13	185/60-14	185/55-15	205/40-16				
		185/65-13	185/65-14	185/60-15	205/45-16				
		185/70-13	185/70-14	195/50-15	205/50-15				
		195/65-13	195/55-14	195/55-15	215/40-16				
		195/70-13	195/60-14	205/45-15	215/45-16				
		205/60-13	195/65-14	215/45-15	225/40-16				
		215/60-13	205/55-14	215/50-15					
		215/65-13	205/60-14						
		225/55-13							
	235/50-13								
L		185/80-13	165-14	175/70-15	175/70-16	175/65-17	205/40-18	215/35-19	206200801
		185-13	175/80-14	175/75-15	185/55-16	185/60-17	205/45-18		
		195/75-13	175-14	185/65-15	185/60-16	205/45-17	215/35-18		
		205/70-13	185/75-14	185/70-15	185/65-16	215/45-17			
			185/80-14	195/65-15	185/65-16				
			185-14	195/70-15	195/55-16				
			195/70-14	205/55-15	195/60-16				
			195/75-14	205/60-15	195/65-16				
			205/65-14	205/65-15	205/50-16				
			205/70-14	215/55-15	205/55-16				
			215/60-14		215/50-16				
			215/65-14						



ÖNorm V 5121: 2007
PPP 53219: 2000
DIN 31000: 1979

UTILIZZABILI PER L'OSSERVAZA DELL'OBBLIGO CATENE A BORDO

La sentenza del Tribunale Amministrativo Regionale per il Lazio (Roma) del 28 giugno 2013 ha confermato che gli automobilisti possono utilizzare le catene in tessuto AutoSock® in presenza del segnale di obbligo di avere catene neve o in alternativa pneumatici invernali montati.



L'UNICA ORIGINALE E BREVETTATA



VELOCE, PRATICO E SOPRATTUTTO SICURO.

Le qualità di SnowGecko sono garantite oltre che dalle certificazioni anche da numerosi riconoscimenti e premi internazionali



IDEALE PER LE VETTURE MODERNE

SnowGecko è adatto per tutti i veicoli con poco spazio tra la ruota, le parti meccaniche e la carrozzeria.

Serie COMPACT

Solo 4 misure per coprire il 90 % della quota di mercato pneumatici Auto

COMPACT Series

4 sizes only but sufficient to cover 90% of car tire sizes on the market



SNOWGECKO
Adatta per la vetture con pneumatici di dimensioni normali

Scatola / Box 12

X-treme

SET 4 COPRICERCHI LINEA "X-TREME"

Realizzati in ABS di ultima generazione.
Anello in acciaio temperato.
Di facile montaggio

SET OF HIGH-QUALITY WHEEL COVERS

Break resistant, advanced engineered ABS material.
Steel wire ring retention system.
Easy to install



4 pcs

**Verniciatura speciale
Special paint**



C-139 MATT BLACK

31221	Ø 14"
31222	Ø 15"
31223	Ø 16"

Scatola / Box 4

RICAMBIO 1 PZ SPARE PART 1 PC

31221S	Ø 14"
31222S	Ø 15"
31223S	Ø 16"

Sfuso / Bulk 1



C-139 ANTHRACITE

31226	Ø 14"
31227	Ø 15"
31228	Ø 16"

Scatola / Box 4

RICAMBIO 1 PZ SPARE PART 1 PC

31226S	Ø 14"
31227S	Ø 15"
31228S	Ø 16"

Sfuso / Bulk 1



C-139

31256	Ø 14"
31257	Ø 15"
31258	Ø 16"

Scatola / Box 4

RICAMBIO 1 PZ SPARE PART 1 PC

31256S	Ø 14"
31257S	Ø 15"
31258S	Ø 16"

Sfuso / Bulk 1



C-140

31260	Ø 13"
31261	Ø 14"
31262	Ø 15"
31263	Ø 16"

Scatola / Box 4

RICAMBIO 1 PZ SPARE PART 1 PC

31260S	Ø 13"
31261S	Ø 14"
31262S	Ø 15"
31263S	Ø 16"

Sfuso / Bulk 1



C-137 SILVER BLACK

31236	Ø 14"
31237	Ø 15"
31238	Ø 16"

Scatola / Box 4

RICAMBIO 1 PZ SPARE PART 1 PC

31236S	Ø 14"
31237S	Ø 15"
31238S	Ø 16"

Sfuso / Bulk 1



C-137

31245	Ø 13"
31246	Ø 14"
31247	Ø 15"
31248	Ø 16"

Scatola / Box 4

RICAMBIO 1 PZ SPARE PART 1 PC

31245S	Ø 13"
31246S	Ø 14"
31247S	Ø 15"
31248S	Ø 16"

Sfuso / Bulk 1



**C-136
SILVER BLACK**

31230	Ø 13"
31231	Ø 14"
31232	Ø 15"
31233	Ø 16"

Scatola / Box 4

**RICAMBIO 1 PZ
SPARE PART 1 PC**

31230S	Ø 13"
31231S	Ø 14"
31232S	Ø 15"
31233S	Ø 16"

Sfuso / Bulk 1



C-136

31240	Ø 13"
31241	Ø 14"
31242	Ø 15"
31243	Ø 16"

Scatola / Box 4

**RICAMBIO 1 PZ
SPARE PART 1 PC**

31240S	Ø 13"
31241S	Ø 14"
31242S	Ø 15"
31243S	Ø 16"

Sfuso / Bulk 1



C-138

31250	Ø 13"
31251	Ø 14"
31252	Ø 15"
31253	Ø 16"

Scatola / Box 4

**RICAMBIO 1 PZ
SPARE PART 1 PC**

31250S	Ø 13"
31251S	Ø 14"
31252S	Ø 15"
31253S	Ø 16"

Sfuso / Bulk 1



C-071 BLACK

31188	Ø 13"
31189	Ø 14"
31190	Ø 15"
31191	Ø 16"

Scatola / Box 4

**RICAMBIO 1 PZ
SPARE PART 1 PC**

31188S	Ø 13"
31189S	Ø 14"
31190S	Ø 15"
31191S	Ø 16"

Sfuso / Bulk 1



**C-071
MATT WHITE**

31192	Ø 13"
31193	Ø 14"
31194	Ø 15"
31195	Ø 16"

Scatola / Box 4

**RICAMBIO 1 PZ
SPARE PART 1 PC**

31192S	Ø 13"
31193S	Ø 14"
31194S	Ø 15"
31195S	Ø 16"

Sfuso / Bulk 1



**C-124
BLACK/SILVER**

31196	Ø 14"
31197	Ø 15"
31198	Ø 16"

Scatola / Box 4

**RICAMBIO 1 PZ
SPARE PART 1 PC**

31196S	Ø 14"
31197S	Ø 15"
31198S	Ø 16"

Sfuso / Bulk 1



**C-118
BLACK/RED**

31199	Ø 13"
31200	Ø 14"
31201	Ø 15"
31202	Ø 16"

Scatola / Box 4

**RICAMBIO 1 PZ
SPARE PART 1 PC**

31199S	Ø 13"
31200S	Ø 14"
31201S	Ø 15"
31202S	Ø 16"

Sfuso / Bulk 1



**CC-124
CHROME/BLACK**

31050	Ø 14"
31051	Ø 15"

Scatola / Box 4

**RICAMBIO 1 PZ
SPARE PART 1 PC**

31050S	Ø 14"
31051S	Ø 15"

Sfuso / Bulk 1

X-treme

**SET 4 COPRICERCHI
QUALITÀ "X-TREME"**

In ABS, verniciatura doppio strato metallizzata lucida con bulloni cromati. Di facile montaggio. Con anello in acciaio temperato

SET OF HIGH-QUALITY WHEEL COVERS

Super hard gloss, clear coat finish. Steel wire ring retention system. Break resistant, advanced engineered ABS material.

Scatola / Box 4



C-089

- 31134** Ø 13"
- 31135** Ø 14"
- 31136** Ø 15"

Scatola / Box 4

**RICAMBIO 1 PZ
SPARE PART 1 PC**

- 31134S** Ø 13"
- 31135S** Ø 14"
- 31136S** Ø 15"

Sfuso / Bulk 1



C-071

- 31138** Ø 13"
- 31139** Ø 14"
- 31140** Ø 15"

Scatola / Box 4

**RICAMBIO 1 PZ
SPARE PART 1 PC**

- 31138S** Ø 13"
- 31139S** Ø 14"
- 31140S** Ø 15"

Sfuso / Bulk 1



C-118

- 31141** Ø 14"
- 31142** Ø 15"
- 31143** Ø 16"

Scatola / Box 4

**RICAMBIO 1 PZ
SPARE PART 1 PC**

- 31141S** Ø 14"
- 31142S** Ø 15"
- 31143S** Ø 16"

Sfuso / Bulk 1



C-120

- 31144** Ø 14"
- 31145** Ø 15"
- 31146** Ø 16"

Scatola / Box 4

**RICAMBIO 1 PZ
SPARE PART 1 PC**

- 31144S** Ø 14"
- 31145S** Ø 15"
- 31146S** Ø 16"

Sfuso / Bulk 1



C-111

- 31147** Ø 14"
- 31148** Ø 15"
- 31149** Ø 16"

Scatola / Box 4

**RICAMBIO 1 PZ
SPARE PART 1 PC**

- 31147S** Ø 14"
- 31148S** Ø 15"
- 31149S** Ø 16"

Sfuso / Bulk 1



C-099

- 31150** Ø 13"
- 31151** Ø 14"
- 31152** Ø 15"
- 31153** Ø 16"

Scatola / Box 4

**RICAMBIO 1 PZ
SPARE PART 1 PC**

- 31150S** Ø 13"
- 31151S** Ø 14"
- 31152S** Ø 15"
- 31153S** Ø 16"

Sfuso / Bulk 1

Tech-One

SET 4 COPRICERCHI DI ALTA QUALITÀ

Universali, in ABS, verniciatura doppio strato. Montaggio facile e veloce: i ganci di fissaggio in resina evitano graffi, l'anello in acciaio temperato, garantisce una perfetta aderenza

SET OF HIGH-QUALITY WHEEL COVERS

Give a special look to your car. Advanced engineered ABS material. High gloss finish. Steel wire ring retention system. Expanding clamping rings ensure pressure on all fixing latches. Suitable for the majority of steel-made wheel rims.

4 pcs



ACTIVE SILVER

31555	Ø 13"
31556	Ø 14"
31557	Ø 15"
31558	Ø 16"

Scatola / Box 3

**RICAMBIO 1 PZ
SPARE PART 1 PC**

31555S	Ø 13"
31556S	Ø 14"
31557S	Ø 15"
31558S	Ø 16"

Sfuso / Bulk 20



ACTIVE GRAFITE

31560	Ø 13"
31561	Ø 14"
31562	Ø 15"
31563	Ø 16"

Scatola / Box 3

**RICAMBIO 1 PZ
SPARE PART 1 PC**

31560S	Ø 13"
31561S	Ø 14"
31562S	Ø 15"
31563S	Ø 16"

Sfuso / Bulk 20



AVERA SILVER

31610	Ø 13"
31611	Ø 14"
31612	Ø 15"
31613	Ø 16"

Scatola / Box 5



AVERA SILVER & BLACK

31615	Ø 13"
31616	Ø 14"
31617	Ø 15"
31618	Ø 16"

Scatola / Box 5





**AVALONE
SILVER & BLACK**

31620	Ø 13"
31621	Ø 14"
31622	Ø 15"
31623	Ø 16"

Scatola / Box 5



AVALONE PRO

31520	Ø 13"
31521	Ø 14"
31522	Ø 15"
31523	Ø 16"

Scatola / Box 5

**RICAMBIO 1 PZ
SPARE PART 1 PC**

31520S	Ø 13"
31521S	Ø 14"
31522S	Ø 15"
31523S	Ø 16"

Sfuso / Bulk 20



**AVALONE PRO
BLACK**

31525	Ø 13"
31526	Ø 14"
31527	Ø 15"
31528	Ø 16"

Scatola / Box 5

**RICAMBIO 1 PZ
SPARE PART 1 PC**

31525S	Ø 13"
31526S	Ø 14"
31527S	Ø 15"
31528S	Ø 16"

Sfuso / Bulk 20



**AVALONE PRO
DARK**

31530	Ø 13"
31531	Ø 14"
31532	Ø 15"
31533	Ø 16"

Scatola / Box 5

**RICAMBIO 1 PZ
SPARE PART 1 PC**

31530S	Ø 13"
31531S	Ø 14"
31532S	Ø 15"
31533S	Ø 16"

Sfuso / Bulk 20



**DAYTONA-PRO
SILVER**

31630	Ø 13"
31631	Ø 14"
31632	Ø 15"
31633	Ø 16"

Scatola / Box 5



NERO

31510	Ø 13"
31511	Ø 14"
31512	Ø 15"
31513	Ø 16"

Scatola / Box 5

**RICAMBIO 1 PZ
SPARE PART 1 PC**

31510S	Ø 13"
31511S	Ø 14"
31512S	Ø 15"
31513S	Ø 16"

Sfuso / Bulk 20





NERO DARK

31515	Ø 13"
31516	Ø 14"
31517	Ø 15"
31518	Ø 16"

Scatola / Box 5

**RICAMBIO 1 PZ
SPARE PART 1 PC**

31515S	Ø 13"
31516S	Ø 14"
31517S	Ø 15"
31518S	Ø 16"

Sfuso / Bulk 20



**NERO
BLACK & SILVER**

31625	Ø 13"
31626	Ø 14"
31627	Ø 15"
31628	Ø 16"

Scatola / Box 5



ROYAL BLACK

31550	Ø 13"
31551	Ø 14"
31552	Ø 15"
31553	Ø 16"

Scatola / Box 3

**RICAMBIO 1 PZ
SPARE PART 1 PC**

31550S	Ø 13"
31551S	Ø 14"
31552S	Ø 15"
31553S	Ø 16"

Sfuso / Bulk 20



ROYAL SILVER

31540	Ø 13"
31541	Ø 14"
31542	Ø 15"
31543	Ø 16"

Scatola / Box 3

**RICAMBIO 1 PZ
SPARE PART 1 PC**

31540S	Ø 13"
31541S	Ø 14"
31542S	Ø 15"
31543S	Ø 16"

Sfuso / Bulk 20



SILVERSTONE

31505	Ø 13"
31506	Ø 14"
31507	Ø 15"
31508	Ø 16"

Scatola / Box 5

**RICAMBIO 1 PZ
SPARE PART 1 PC**

31505S	Ø 13"
31506S	Ø 14"
31507S	Ø 15"
31508S	Ø 16"

Sfuso / Bulk 20



SPARK SILVER

31585	Ø 13"
31586	Ø 14"
31587	Ø 15"
31588	Ø 16"
31589	Ø 17"

Scatola / Box 5



SPORTIVE

31495	Ø 13"
31496	Ø 14"
31497	Ø 15"
31498	Ø 16"

Scatola / Box 5

**RICAMBIO 1 PZ
SPARE PART 1 PC**

31495S	Ø 13"
31496S	Ø 14"
31497S	Ø 15"
31498S	Ø 16"

Sfuso / Bulk 20



**STRATOS RC
SILVER**

31595	Ø 13"
31596	Ø 14"
31597	Ø 15"
31598	Ø 16"
31599	Ø 17"

Scatola / Box 5



**STRATOS RC
GRAFITE**

31600	Ø 13"
31601	Ø 14"
31602	Ø 15"
31603	Ø 16"
31604	Ø 17"

Scatola / Box 3



**STRATOS RC
BLACK**

31605	Ø 13"
31606	Ø 14"
31607	Ø 15"
31608	Ø 16"
31609	Ø 17"

Scatola / Box 3



**TREND DC RC
BLACK & SILVER**

31590	Ø 13"
31591	Ø 14"
31592	Ø 15"
31593	Ø 16"

Scatola / Box 3



TREND GRAFITE

31575	Ø 13"
31576	Ø 14"
31577	Ø 15"
31578	Ø 16"

Scatola / Box 3

**RICAMBIO 1 PZ
SPARE PART 1 PC**

31575S	Ø 13"
31576S	Ø 14"
31577S	Ø 15"
31578S	Ø 16"

Sfuso / Bulk 20



TREND BLACK

31580	Ø 13"
31581	Ø 14"
31582	Ø 15"
31583	Ø 16"

Scatola / Box 3

**RICAMBIO 1 PZ
SPARE PART 1 PC**

31580S	Ø 13"
31581S	Ø 14"
31582S	Ø 15"
31583S	Ø 16"

Sfuso / Bulk 20



TREND BICOLOUR

31570	Ø 13"
31571	Ø 14"
31572	Ø 15"
31573	Ø 16"

Scatola / Box 3

**RICAMBIO 1 PZ
SPARE PART 1 PC**

31570S	Ø 13"
31571S	Ø 14"
31572S	Ø 15"
31573S	Ø 16"

Sfuso / Bulk 20



SPEED VAN

31535	Ø 15"
31536	Ø 16"

Scatola / Box 5

**RICAMBIO 1 PZ
SPARE PART 1 PC**

31535S	Ø 15"
31536S	Ø 16"

Sfuso / Bulk 20



**PER FURGONI / CAMPER
FOR VANS / MOTORHOME**

Bombatura maggiorata
specifica per i cerchi di
camper e furgoni.

Specially studied for
vehicles category with
positive offset wheels

Tech-One

4 pcs

SET 4 COPRICERCHI DI ALTA QUALITÀ

Universali, in ABS, verniciatura doppio strato. Montaggio facile e veloce: i ganci di fissaggio in resina evitano graffi, l'anello in acciaio temperato, garantisce una perfetta aderenza

SET OF HIGH-QUALITY WHEEL COVERS

Give a special look to your car. Advanced engineered ABS material. High gloss finish. Steel wire ring retention system. Expanding clamping rings ensure pressure on all fixing latches. Suitable for the majority of steel-made wheel rims.



DISCOVERY SILVER

31640	Ø 13"
31641	Ø 14"
31642	Ø 15"
31643	Ø 16"

Scatola / Box 5



SEPANG SILVER

31650	Ø 13"
31651	Ø 14"
31652	Ø 15"
31653	Ø 16"
31654	Ø 17"

Scatola / Box 5



SEPANG SILVER & BLACK

31655	Ø 13"
31656	Ø 14"
31657	Ø 15"
31658	Ø 16"
31659	Ø 17"

Scatola / Box 5



MODENA BLACK & SILVER

31645	Ø 13"
31646	Ø 14"
31647	Ø 15"
31648	Ø 16"

Scatola / Box 5



MULTI SILVER

31635	Ø 13"
31636	Ø 14"
31637	Ø 15"
31638	Ø 16"

Scatola / Box 5



1
pc

COPRICERCHIO UNIVERSALE
In ABS antiurto
con anello di tenuta
UNIVERSAL WHEEL COVER
Break resistant ABS material.
Wire ring retention system

Termo+cavaliere / Shrink+Header 8



CORDOBA

- 30750** Ø 13"
- 30751** Ø 14"



SPRINT

- 30810** Ø 13"
- 30811** Ø 14"
- 30812** Ø 15"
- 30813** Ø 16"



TURBO

- 30817** Ø 13"
- 30818** Ø 14"
- 30819** Ø 15"



OPTIMA

- 30834** Ø 13"
- 30835** Ø 14"
- 30836** Ø 15"



JEREZ

- 30740** Ø 13"
- 30741** Ø 14"
- 30742** Ø 15"
- 30743** Ø 16"



SEPANG

- 30744** Ø 13"
- 30745** Ø 14"
- 30746** Ø 15"

Rim Ringz

SET 4 PROTEZIONI RIM RINGZ™

- Proteggono i cerchi in lega da urti e collisioni con cordoli e marciapiedi.
- Migliorano l'estetica dell'auto.
- Nascondono ammaccature esistenti.
- Disponibili per le misure 15", 16", 17", 18", 19" e 20".
- Disponibili in varie colorazioni.
- Realizzate in materiale di alta qualità

SET OF 4 PROTECTIONS RIM RINGZ™

- Prevents damage to the edges of your rims.
- Improves the appearance of your car's rims.
- Hides existing curb damage.
- Available for wheels: 15", 16", 17", 18", 19" and 20".
- Available in 3 colours.

Scatola / Box 5



Disponibili per cerchi:
Available for wheels:
15" - 16" - 17" - 18" - 19" - 20"

4 pcs

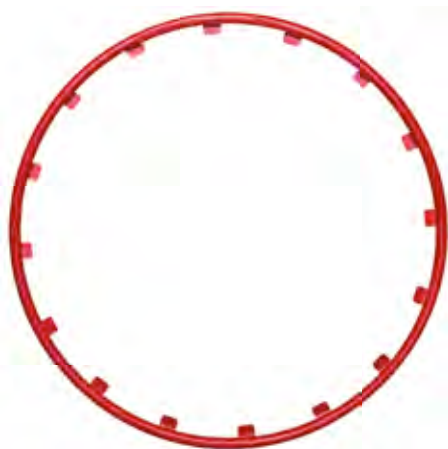

ROSSO - RED

RR15100	15"
RR16100	16"
RR17100	17"
RR18100	18"
RR19100	19"
RR20100	20"



ARGENTO - SILVER

RR15101	15"
RR16101	16"
RR17101	17"
RR18101	18"
RR19101	19"
RR20101	20"



NERO - BLACK

RR15102	15"
RR16102	16"
RR17102	17"
RR18102	18"
RR19102	19"
RR20102	20"



Lista delle combinazioni appropriate cerchio/pneumatico per RIM RINGZ
 List of appropriate wheel/tire size combinations for RIM RINGZ

	Pneumatico Tire Size	Cerchio Wheel Size	Pneumatico Tire Size	Cerchio Wheel Size	Pneumatico Tire Size	Cerchio Wheel Size	Pneumatico Tire Size	Cerchio Wheel Size	Pneumatico Tire Size	Cerchio Wheel Size
15"	155/60R15	4.5 x 15"	185/65R15	5 x 15"	205/50R15	5.5 x 15"	215/80R15	6 x 15"	235/75R15	6.5 x 15"
	165/50R15	4.5 x 15"	195/45R15	6.5 x 15"	205/55R15	7.5 x 15"	225/45R15	6 x 15"	245/75R15	7 x 15"
	165/55R15	4.5 x 15"	195/50R15	5.5 x 15"	205/60R15	5.5 x 15"	225/50R15	6 x 15"	255/65R15	7 x 15"
	175/55R15	5 x 15"	195/55R15	5.5 x 15"	205/65R15	5.5 x 15"	225/60R15	6 x 15"	255/70R15	7 x 15"
	175/60R15	5 x 15"	195/60R15	5.5 x 15"	205/70R15	5.5 x 15"	225/70R15	6 x 15"	265/70R15	7.5 x 15"
	175/65R15	5 x 15"	195/65R15	5.5 x 15"	215/60R15	6 x 15"	225/75R15	6 x 15"	30x950R15	7.5 x 15"
	185/55R15	5 x 15"	195/70R15	5.5 x 15"	215/65R15	6 x 15"	225/80R15	6 x 15"	31x1050R15	8 x 15"
	185/60R15	5 x 15"	195/80R15	5.5 x 15"	215/70R15	6 x 15"	235/70R15	6.5 x 15"		
16"	175/60R16	5 x 16"	195/60R16	5.5 x 16"	215/35R16	7 x 16"	225/45R16	7.5 x 16"	235/70R16	6.5 x 16"
	175/65R16	5 x 16"	195/65R16	5.5 x 16"	215/40R16	7 x 16"	225/50R16	6 x 16"	245/70R16	7 x 16"
	185/50R16	5 x 16"	195/75R16	5.5 x 16"	215/45R16	7 x 16"	225/55R16	6 x 16"	255/55R16	7 x 16"
	185/55R16	5 x 16"	205/40R16	7 x 16"	215/55R16	6 x 16"	225/60R16	6 x 16"	255/60R16	7 x 16"
	185/60R16	5 x 16"	205/45R16	6.5 x 16"	215/60R16	6 x 16"	225/65R16	6 x 16"	255/65R16	7 x 16"
	185/75R16	5 x 16"	205/50R16	5.5 x 16"	215/65R16	6 x 16"	225/70R16	6 x 16"	255/70R16	7 x 16"
	195/40R16	6.5 x 16"	205/55R16	5.5 x 16"	215/70R16	6 x 16"	225/75R16	6 x 16"	265/70R16	7.5 x 16"
	195/45R16	6.5 x 16"	205/60R16	5.5 x 16"	215/75R16	6 x 16"	235/50R16	6.5 x 16"	265/75R16	7.5 x 16"
	195/50R16	5.5 x 16"	205/65R16	5.5 x 16"	215/80R16	6 x 16"	235/60R16	6.5 x 16"	275/70R16	7.5 x 16"
	195/55R16	5.5 x 16"	205/75R16	5.5 x 15"	225/40R16	7.5 x 16"	235/65R16	6.5 x 16"		
17"	195/40R17	6.5 x 17"	215/50R17	6 x 17"	225/65R17	6 x 17"	235/70R17	6.5 x 17"	255/50R17	7 x 17"
	195/45R17	6.5 x 17"	215/55R17	6 x 17"	225/70R17	6 x 17"	245/35R17	8 x 17"	255/55R17	7 x 17"
	205/40R17	7 x 17"	215/60R17	6 x 17"	235/40R17	8 x 17"	245/40R17	8 x 17"	255/60R17	7 x 17"
	205/45R17	7 x 17"	225/35R17	7.5 x 17"	235/45R17	8 x 17"	245/45R17	8 x 17"	255/65R17	7 x 17"
	205/50R17	5.5 x 17"	225/45R17	7.5 x 17"	235/50R17	6.5 x 17"	245/50R17	7 x 17"	265/40R17	9 x 17"
	205/55R17	5.5 x 17"	225/50R17	6 x 17"	235/55R17	6.5 x 17"	245/55R17	7 x 17"	275/40R17	9 x 17"
	215/40ZR17	7 x 17"	225/55R17	6 x 17"	235/60R17	6.5 x 17"	255/40R17	8.5 x 17"		
	215/45R17	7 x 17"	225/60R17	6 x 17"	235/65R17	6.5 x 17"	255/45R17	8.5 x 17"		
18"	215/35R18	7 x 18"	225/60R18	6 x 18"	235/60R18	6.5 x 18"	255/50R18	7 x 18"	285/30R18	9.5 x 18"
	215/40R18	7 x 18"	225/65R18	6 x 18"	235/65R18	6.5 x 18"	255/55R18	7 x 18"	285/35R18	9.5 x 18"
	215/45R18	7 x 18"	235/30R18	8 x 18"	245/35R18	8 x 18"	255/60R18	7 x 18"	285/40R18	9.5 x 18"
	225/35R18	7.5 x 18"	235/35R18	8 x 18"	245/40R18	8 x 18"	265/35R18	9 x 18"	285/45R18	9.5 x 18"
	225/40R18	7.5 x 18"	235/40R18	8 x 18"	245/50R18	7 x 18"	265/40R18	9 x 18"	285/50R18	8 x 18"
	225/45R18	7.5 x 18"	235/45R18	8 x 18"	255/35R18	8.5 x 18"	275/35R18	9 x 18"	285/55R18	8 x 18"
	225/50R18	6 x 18"	235/50R18	6.5 x 18"	255/40R18	8.5 x 18"	275/40R18	9 x 18"	295/30R18	10 x 18"
	225/55R18	6 x 18"	235/55R18	6.5 x 18"	255/45R18	8.5 x 18"	275/45R18	9 x 18"	295/35R18	10 x 18"
19"	215/35R19	7 x 19"	235/55R19	6.5 x 19"	255/50R19	7 x 19"	275/50R19	7.5 x 19"	295/45R19	10 x 19"
	225/35R19	7.5 x 19"	245/35R19	8 x 19"	255/55R19	7 x 19"	275/55R19	7.5 x 19"	305/30R19	10 x 19"
	225/40R19	7.5 x 19"	245/40R19	8 x 19"	265/30R19	9 x 19"	285/30R19	9.5 x 19"	315/25R19	10.5 x 19"
	225/45R19	7.5 x 19"	245/45R19	8 x 19"	275/30R19	9 x 19"	285/35R19	9.5 x 19"	315/30R19	10.5 x 19"
	235/35R19	8 x 19"	255/35R19	8.5 x 19"	275/35R19	9 x 19"	285/40R19	9.5 x 19"		
	235/40R19	8 x 19"	255/40R19	8.5 x 19"	275/40R19	9 x 19"	285/45R19	9.5 x 19"		
	235/50R19	6.5 x 19"	255/45R19	8.5 x 19"	275/45R19	9 x 19"	295/30R19	10 x 19"		
20"	225/30R20	7.5 x 20"	245/40R20	8 x 20"	265/30R20	9 x 20"	275/45R20	9 x 20"	295/35R20	10 x 20"
	225/35R20	7.5 x 20"	245/45R20	8 x 20"	265/35R20	9 x 20"	275/50R20	7.5 x 20"	295/40R20	10 x 20"
	235/30R20	8 x 20"	245/50R20	7 x 20"	265/40R20	9 x 20"	285/25R20	9.5 x 20"	295/45R20	10 x 20"
	235/35R20	8 x 20"	255/30R20	8.5 x 20"	265/45R20	9 x 20"	285/30R20	9.5 x 20"	305/25R20	10 x 20"
	235/45R20	8 x 20"	255/35R20	8.5 x 20"	265/50R20	7.5 x 20"	285/35R20	9.5 x 20"	305/30R20	10 x 20"
	235/55R20	6.5 x 20"	255/40R20	8.5 x 20"	275/30R20	9 x 20"	285/40R20	9.5 x 20"	305/35R20	10 x 20"
	245/30R20	8 x 20"	255/45R20	8.5 x 20"	275/35R20	9 x 20"	285/50R20	8 x 20"	315/35R20	10.5 x 20"
	245/35R20	8 x 20"	255/50R20	7 x 20"	275/40R20	9 x 20"	295/30R20	10 x 20"	325/30R20	11 x 20"

Rim-Stickers

RIM-STICKERS, PROFILI ADESIVI RUOTA

- Pre-sagomati, pronti per una facile applicazione senza pieghe o grinze.
- Materiale plastico ed adesivo specifici per uso esterno.
- Semplice da applicare e di grande effetto visivo.

RIM-STICKERS

- Pre-cut, ready for an easy and simple application without creases or wrinkles.
- Special Plastic material and adhesive for exterior use.
- Standout in the crowd

D/Blister 10 / 100

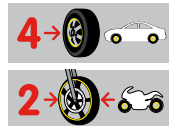

16
pcs



PER CERCHI FOR WHEELS **14" - 15" - 16"**

30780	Cromo	Chrome	SIZE 1
30781	Verde	Green	
30782	Arancio	Orange	
30783	Rosso	Red	
30784	Giallo	Yellow	

PER CERCHI FOR WHEELS **17" - 18" - 19" - 20"**

30785	Cromo	Chrome	SIZE 2
30786	Verde	Green	
30787	Arancio	Orange	
30788	Rosso	Red	
30789	Giallo	Yellow	



Copribulloni in Silicone



SILICONE NUT CAPS,

COPRIBULLONI IN SILICONE NERO

Il tocco finale per coprire i bulloni e valorizzare i cerchi in lega di colore nero. Alta resistenza alle alte e basse temperature. Si montano a pressione sui bulloni originali

SILICONE NUT CAPS

The final touch to enhance your wheels. High and low temp resistant. Easy push-on fitting

02244	17 mm
02245	19 mm
02246	21 mm

D/Blister 10 / 100

20
pcs



Copribulloni in ABS

20
pcs

COPRIBULLONI 20 PZ

Si montano a pressione sui bulloni originali e possono essere rimossi utilizzando l'apposita pinza in dotazione.

NUT CAPS, 20 PCS

Easy push-on fitting. Caps lock in position and can be removed by the special tool included



Alfa Romeo (>99)	19 mm	Mercedes	17 mm
Alfa Romeo (99>)	17 mm	Opel	17 mm
Audi	17 mm	Peugeot (>08/03)	19 mm
BMW	17 mm	Peugeot (08/03>)	17 mm
Chevrolet \ Daewoo	19 mm	Porsche	17 mm
Chrysler	19 mm	Renault	19 mm
Citroen (>08/03)	19 mm	Rover	19 mm
Citroen (08/03>)	17 mm	Saab (>98)	19 mm
Fiat (>99)	19 mm	Saab (98>)	17 mm
Fiat (99>)	17 mm	Seat	17 mm
Ford	19 mm	Skoda	17 mm
Honda	19 mm	Smart	17 mm
Jaguar	19 mm	Subaru	19 mm
Jeep	19 mm	Suzuki	19 mm
Lancia (>99)	19 mm	Volkswagen	17 mm
Lancia (99>)	17 mm	Volvo	19 mm
Lotus	17 mm	Volvo 340, 360, 440, 460, 480	17 mm



**In ABS nero
Black ABS**

02248 Ø 17 mm
02249 Ø 19 mm

Blister 10 / 100

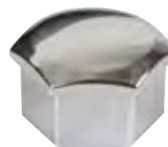

**In ABS cromato
Chromed ABS**

02241 Ø 17 mm
02242 Ø 19 mm

Blister 10 / 100



Copribulloni in Acciaio

20
pcs

COPRIBULLONI 20 PZ

Si montano a pressione sui bulloni originali e possono essere rimossi utilizzando l'apposita pinza in dotazione.

NUT CAPS, 20 PCS

Easy push-on fitting. Caps lock in position and can be removed by the special tool included



**In acciaio cromato
Chromed steel**

02238 Ø 17 mm
02239 Ø 19 mm

D/Blister 10 / 100





TAPPI COPRIVALVOLA IN ABS
Universali, auto, camion e moto

ABS TYRE VALVE CAPS
Universal for car, truck and motorcycle

02488	5 pz / pcs	Busta / Bag	100 / 1000
02489	100 pz / pcs	Busta / Bag	10 / 100



SPORT-CAP, BRILLIANT SERIES

Set 4 tappi coprivalvola universali per auto e moto. Con guarnizione in gomma

SPORT-CAP, BRILLIANT SERIES
Set of 4 tyre valve caps. Universal for cars and motorcycles. With rubber gasket

02479	Nero	Black
02480	Alluminio	Aluminium
02481	Titanio	Titanium

D/Blister 10 / 100



COVER-KIT

Set 4 tappi e 4 manicotti coprivalvola, in lega di alluminio e ottone. Universali per tutte le valvole auto, moto e scooter

COVER-KIT
Valve cap and Sleeve set 4 pcs/Kit

02506

D/Blister 10 / 100



SAFETY CAP

Tappi coprivalvola in lega di alluminio. Con guarnizione interna e doppio collare di fissaggio valvola-tappo. Universali

SAFETY CAP
Aluminium alloy valve caps. With interior o-ring and double safety collar for valve-cap link. Universal

02507

D/Blister 10 / 100



VERDE / GREEN
pressione corretta
correct pressure



ROSSO / RED
pressione bassa
low pressure

PRESSURE CONTROLLER

Tappi coprivalvola con indicatore di pressione pneumatici. Brevettati.

PRESSURE CONTROLLER
Tire pressure indicator caps. Patented.

2 pz / pcs

02472	1.8 Bar
02473	2.0 Bar
02474	2.2 Bar
02475	2.4 Bar
02476	2.6 Bar
02477	2.8 Bar

D/Blister 10 / 100



4 pz / pcs

02482	1.8 Bar
02483	2.0 Bar
02484	2.2 Bar
02485	2.4 Bar
02486	2.6 Bar
02487	2.8 Bar

D/Blister 10 / 100





PENNARELLO PER PNEUMATICI
Vernice ad alta copertura. Resistente all'acqua ed agli agenti atmosferici.

TIRE PAINT PEN
High resistant instant dry paint marker

74101	Bianco	White
74102	Argento	Silver

D/Blister 10 / 200



BULLET

Set 4 tappi coprivalvola in lega di alluminio bicolore. Universali per tutte le valvole auto/moto

BULLET
Set of 4 aluminium valve caps. Universal, fits all car/bike valves.

02496	Titanio	Titanium
02497	Blu	Blue
02498	Rosso	Red

D/Blister 10 / 100



SPORT-CAP

Set 4 tappi coprivalvola in lega di alluminio. Universali auto/moto.

SPORT-CAP
Set of 4 aluminium valve caps. Universal, fits all car/bike valves.

02500	Alluminio	Aluminium
02501	Blu	Blue
02502	Rosso	Red

D/Blister 10 / 100



SPORT-CAP HEXAGONAL

Set 4 tappi coprivalvola in lega di alluminio. Universali auto/moto.

SPORT-CAP HEXAGONAL
Set of 4 aluminium valve caps. Universal, fits all car/bike valves.

02503	Alluminio	Aluminium
02504	Blu	Blue
02505	Rosso	Red

D/Blister 10 / 100



CALIFORNIA-DICES, TAPPI COPRIVALVOLA 4 PZ

Stile custom USA per auto, moto e scooter

CALIFORNIA-DICES, TIRE VALVE CAPS, 4 PCS
USA custom-style. Fits all cars and motorcycles

02460	Nero	Black
02463	Azzurro	Light blue
02464	Cromo	Chrome

D/Blister 10 / 100

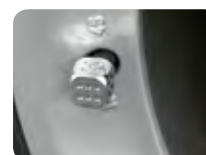



Certificazioni di Qualità Quality Statement

QUALITÀ E SICUREZZA

Il nome "McGard" è famoso in tutto il mondo fin dal 1964 perché sinonimo di qualità e sicurezza. I bulloni antifurto McGard garantiscono un alto livello di protezione contro il furto di cerchi e pneumatici, sono studiati per durare nel tempo e per garantire gli standard di massima sicurezza dettati dalle maggiori industrie automobilistiche.

Tra i migliori clienti si annoverano le principali case automobilistiche in Europa, Giappone e Nord America.

McGard ha ricevuto l'onorificenza come miglior prodotto per la qualità da Ford Motor Company, che solo poche aziende sono riuscite ad ottenere.

Testato e approvato dalla stampa specializzata internazionale (Autoplus, Autoexpress...)

L'azienda McGard ha la filiale europea in Germania mentre la sede centrale negli Stati Uniti.

Entrambe certificate ISO/TS 16949 and ISO 144001.

Tali requisiti a suffragio di una azienda che è coerente con gli standard richiesti, garante della sicurezza che tutti i loro prodotti corrispondono ed oltrepassano i severi requisiti richiesti dal primo equipaggiamento.

QUALITÀ STRAORDINARIA, SERVIZIO ECCELLENTE

Sicuramente potete contare su McGard, **distribuito in Italia da LAMPA SPA.**

QUALITY AND SAFETY

The name McGard has stood for quality and safety since 1964.

Our wheel locks provide the highest level of protection against costly wheel and tyre theft.

Our lug nuts are built to last a life time. McGard has received, among others, the "total Quality Excellence Award" from the Ford Motor Company, an award that only a very few companies worldwide had previously earned.

Continuous winner of Tests by international special press (Autoplus, Autoexpress...)

We are extremely proud of this award that only a very few companies worldwide previously earned.

We are extremely proud of this award since it typifies our commitment to total quality.

McGard Deutschland GmbH is certified in our products.

Our McGard products not only conform to the latest standards in all areas, but exceed them.

OUTSTANDING - EXCELLENT SERVICE

You can count on McGard, **distributed in Italy by LAMPA SPA.**

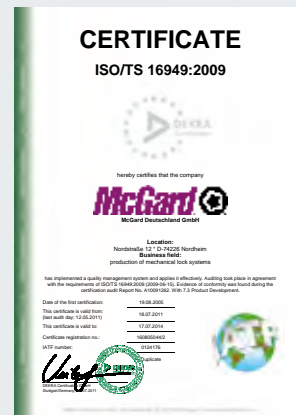

Sperate che non vi accada?! ...Offriamo **infinite possibilità** per evitarlo...

You hope this never happens to you?! ...We offer you an **infinite number of possibilities** to avoid it....



ESAGONO DELLA CHIAVE

Le chiavi McGard hanno lo stesso esagono dei bulloni di serie dei singoli veicoli.

KEY HEX SIZE

McGard keys have the proper hex size to match the vehicles lug wrench.

PROFILO DEI SOLCHI ESTREMAMENTE SOTTILE

Il profilo dei solchi estremamente sottile impedisce che il bullone McGard possa essere svitato con normali attrezzi.

EXTRA NARROW GROOVE KEY PATTERNS

The narrow groove resists the intrusion of lock removal tools into the pattern.

SEDE BULLONE SU MISURA

Lo standard interno della McGard per la concentricità della sede bullone e del diametro medio della filettatura è il 30% più preciso dello standard applicato dall'industria automobilistica.

BEARING SURFACE

McGard's standard for concentricity of the bearing surface to the pitch diameter is 30% more precise than OEM standards.

ACCIAIO TEMPRATO 10.9

Ogni singolo bullone McGard è completamente temprato e bonificato. In questo modo si ottiene la tempra sull'intera sezione, necessaria per l'elevato standard di sicurezza McGard.

10.9 THROUGH-HARDENED STEEL

Every lock is through-hardened and tempered, reaching the depth of hardness needed for its unsurpassed level of security.

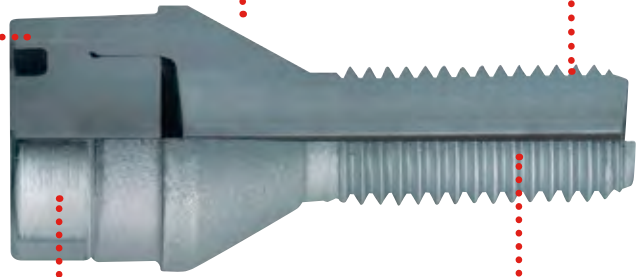
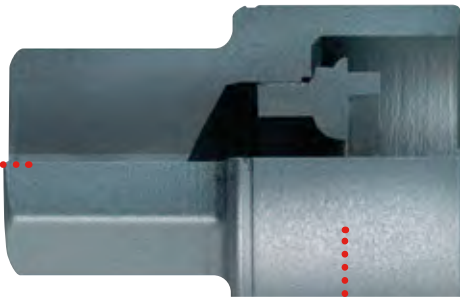

CHIAVE DI FACILE USO

La bussola inserisce la chiave nei solchi dei bulloni McGard e garantisce un facile montaggio e smontaggio.

USER FRIENDLY KEYS

Our steel collar guides the key into the lock pattern and holds the key in alignment for easy installation and removal.

RIVESTIMENTO AL CROMO

Il meglio nel settore dell'automotive: tre strati di nichel e uno microporoso di cromo per la massima resistenza alla corrosione.

CHROME PLATING

The best in the industry. Our process includes three layers of nickel and one layer of microporous chrome for highest corrosion resistance.

FILETTATURA

Tutti i bulloni McGard corrispondono ai severi requisiti del primo equipaggiamento e spesso li superano.

THREADS

All McGard locks meet or exceed the highest OEM proof load standards.

Prova Corrosione

McGard ha testato i suoi prodotti in una camera per il test di corrosione a nebbia salina per verificare la loro resistenza. Il confronto è stato fatto con campioni di altre aziende.

Corrosion Test

They tested products in a CASS (copper-accelerated acetic acid-salt spray) to measure the specific corrosion resistance of nickel-chromium platings. The comparison has been done with products of other factories.

Bulloni e Dadi Nuovi
Brand New Lug Nuts



Risultato dopo circa un anno di esposizione (22 ore).
Approx. 1 year of exposure, 22 hours.



Risultato dopo circa tre anni di esposizione (66 ore).
Approx. 3 years of exposure, 66 hours.



Risultato dopo circa cinque anni di esposizione (110 ore).
Approx. 5 years of exposure, 110 hours.



SERIE "THE ORIGINAL" (SU)

Versione standard della gamma McGard caratterizzata da:

- Acciaio di alta qualità (10.9)
- Trattamento di tempra della testa 46-54 HRC (Rockwell)
- Tripla cromatura al nichel per una massima protezione contro la corrosione.
- Massima sicurezza grazie a centinaia di combinazioni diverse scolpite nell'acciaio
- Peso corrispondente all'originale

"THE ORIGINAL" SERIES (SU)

McGard standard version distinguished by following specifications:

- 10.9 steel quality (referring to the requirements of the car manufacturers)
- Special hardened bolt head 46-54 HRC (Rockwell)
- Highest corrosion protection by using triple nickel chrome plating.
- High security Level hundreds of different codes
- Weight matched



Original **SU**



SERIE "ULTRA-HIGH SECURITY" (SL)

Top della gamma. Alla rinomata sicurezza del bullone antifurto standard, la linea HIGH-SECURITY si contraddistingue per l'aggiunta di un blindatura rotante che aumenta la sicurezza.

Questa versione è stata classificata al livello di sicurezza "4" dall'istituto Inglese Thatcham.

"ULTRA-HIGH SECURITY" SERIES (SL)

Our product which provides additional security due to its rotating ring, fulfils the Thatcham Security Category 4.



Ultra-High Security **SL**



SERIE "BLACK-EDITION" (SUB)

Alla rinomata sicurezza del bullone antifurto standard si aggiunge la finitura nera in PVD della testa, per un "dark-look" coordinato al cerchio e la massima resistenza alla corrosione.

"BLACK-EDITION" SERIES (SUB)

PVD plating. Best corrosion resistance Developed for black wheels, with a selection of the same measurements/ applications as our SU edition.



Black-Edition **SUB**



SERIE "TUNER" (SU)

Specifica per tutte le ruote con foro bullone ridotto e/o profondo. Il diametro della testa del bullone e della chiave sono inferiori allo standard. In questa versione, la chiave è stata appositamente allungata per permettere di agire in profondità nel foro della ruota

"TUNER" SERIES (SU)

Developed for wheels with narrow diameter holes, therefore we have reduced the exterior diameter of our bolts/nuts and also the exterior diameter of the key

Tuner **SU**

ACCIAIO
10.9
STEEL



SERIE LOK-NOX®

Espressamente sviluppata per ottenere la massima copertura del parco circolante con un minimo assortimento di modelli (10 modelli di bulloni e 2 modelli di dadi).

- Acciaio di alta qualità (10.9)
- Buona protezione contro la corrosione (test di oltre 360 ore di nebbia salina)
- Resistente e robusto (testato con coppia di serraggio di 350Nm)

Chiave a doppio esagono 17/19 o 19/21 mm

LOK-NOX® SERIES

Specially developed to guarantee over 90% market coverage with a limited number of references (10 types of bolts and 2 types of nuts).

- 10.9 steel quality (referring to the requirements of the car manufacturers)
- Good corrosion resistance (passed a 360 hours salt spray test without signs of red rust)
- Strong and robust (tested with a 350Nm tightening torque)

Multiple-size key 17/19 or 19/21 mm

Lok-**Nox**®

ACCIAIO
10.9
STEEL



DISPLAY ESPOSITORE DA BANCO PER 10 CONFEZIONI

Fornito senza prodotti

COUNTER DISPLAY FOR 10 BLISTER

Products not included

MG90216

Assortimento consigliato:

- MG27216SU - 2
- MG27170SU - 1
- MG27179SU - 2
- MG27226SU - 1
- MG27184SU - 1
- MG28018SU - 1
- MG26002SU - 1
- MG24012SU - 1



DISPLAY ESPOSITORE DA BANCO PER 24 CONFEZIONI

Fornito senza prodotti

COUNTER DISPLAY FOR 24 BLISTER

Products not included

MG90217

Assortimento consigliato:

- MG27216SU - 4
- MG27170SU - 2
- MG27179SU - 4
- MG27207SU - 1
- MG27226SU - 2
- MG27184SU - 1
- MG28018SU - 2
- MG28028SU - 1
- MG26002SU - 2
- MG25000SU - 1
- MG24012SU - 1
- MG24157SU - 1
- MG24013SU - 1



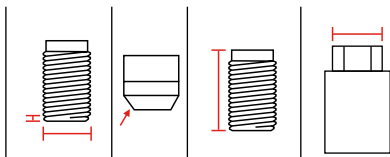

Tipo Type	Dimensione Filetto Thread Size	Sede Seat	Lung. Filetto / Lung. Totale Shaft length / Total Length	Dimensione Chiave Hex Size	Cod. Art. ORIGINAL	Cod. Art. ULTRA HIGH SECURITY	Cod. Art. BLACK EDITION	Cod. Art. TUNER	Cod. Art. LOK NOX
-----------	--------------------------------	-----------	--	----------------------------	--------------------	-------------------------------	-------------------------	-----------------	-------------------

Bulloni conici - Conical Bolts



A010	M12x1,25	60°	22,0 mm	17 mm	MG27216SU	MG27216SL	MG27216SUB	MG27196SU	MG01170
A030	M12x1,25	60°	29,2 mm	17 mm	MG27215SU	MG27215SL	MG27215SUB		MG01215
A040	M12x1,25	60°	40,6 mm	17 mm	MG27232SU				
A050	M12x1,25	60°	22,0 mm	19 mm	MG27170SU	MG27170SL	MG27170SUB		MG01170
A055	M12x1,25	60°	25,6 mm	19 mm	MG27261SU		MG27261SUB		
A060	M12x1,25	60°	29,2 mm	19 mm	MG27169SU	MG27169SL	MG27169SUB		MG01215
A070	M12x1,25	60°	35,6 mm	19 mm	MG27185SU	MG27185SL	MG27185SUB		
A080	M12x1,25	60°	47,8 mm	19 mm	MG27180SU	MG27180SL	MG27180SUB		
A090	M12x1,5	60°	18,2 mm	17 mm	MG27203SU	MG27203SL	MG27203SUB		
A100	M12x1,5	60°	22,1 mm	17 mm	MG27204SU	MG27204SL	MG27204SUB		MG01204
A120	M12x1,5	60°	25,5 mm	17 mm	MG27179SU	MG27179SL	MG27179SUB	MG27192SU	MG01179
A130	M12x1,5	60°	27,9 mm	17 mm	MG27221SU		MG27221SUB	MG27191SU	MG01221
A150	M12x1,5	60°	31,8 mm	17 mm	MG27015SU		MG27015SUB		
A160	M12x1,5	60°	36,3 mm	17 mm	MG27112SU		MG27112SUB		
A170	M12x1,5	60°	40,4 mm	17 mm	MG27013SU	MG27013SL	MG27013SUB		
A175	M12x1,5	60°	45,0 mm	17 mm	MG27252SU				
A180	M12x1,5	60°	49,2 mm	17 mm	MG27014SU				
A190	M12x1,5	60°	25,5 mm	19 mm	MG27207SU	MG27207SL	MG27207SUB		MG01179
A200	M12x1,5	60°	18,2 mm	21 mm			MG27100SUB		
A210	M12x1,75	60°	29,0 mm	19 mm	MG27186SU		MG27186SUB		
A220	M14x1,25	60°	27,3 mm	17 mm	MG27226SU	MG27226SL	MG27226SUB		
A230	M14x1,25	60°	32,0 mm	17 mm	MG27229SU	MG27229SL	MG27229SUB		
A240	M14x1,25	60°	37,0 mm	17 mm	MG27230SU	MG27230SL	MG27230SUB		
A250	M14x1,25	60°	47,0 mm	17 mm	MG27231SU	MG27231SL	MG27231SUB		
A260	M14x1,25	60°	42,0 mm	19 mm	MG27244SU				
A270	M14x1,5	60°	24,0 mm	17 mm	MG27184SU	MG27184SL	MG27184SUB	MG27200SU	
A280	M14x1,5	60°	27,3 mm	17 mm	MG27222SU		MG27222SUB		MG01222
A290	M14x1,5	60°	29,0 mm	17 mm	MG27181SU	MG27181SL	MG27181SUB	MG27201SU	MG01181
A310	M14x1,5	60°	31,0 mm	17 mm	MG27205SU		MG27205SUB		
A320	M14x1,5	60°	39,0 mm	17 mm	MG27183SU		MG27183SUB		
A330	M14x1,5	60°	44,0 mm	17 mm	MG27209SU		MG27209SUB		
A340	M14x1,5	60°	49,0 mm	17 mm	MG27208SU				
A350	M14x1,5	60°	31,0 mm	19 mm	MG27000SU	MG27000SL	MG27000SUB		



Tipo Type	Dimensione Filetto Thread Size	Sede Seat	Lung. Filetto / Lung. Totale Shaft length / Total Length	Dimensione Chiave Hex Size	Cod. Art. ORIGINAL	Cod. Art. ULTRA HIGHT SECURITY	Cod. Art. BLACK EDITION	Cod. Art. TUNER	Cod. Art. LOK NOX
-----------	--------------------------------	-----------	--	----------------------------	--------------------	--------------------------------	-------------------------	-----------------	-------------------

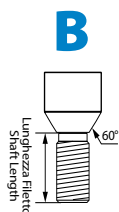

Bulloni Conici per Fiat Ducato - Conical Bolts for Fiat Ducato

B010	M14x1,5	60°	30,0 mm	21 mm	MG27565SU				
B020	M16x1,5	60°	30,0 mm	21 mm	MG27566SU				

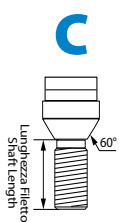

Bulloni con Rondella Conica - Flat Bolts With Conical Washer

C010	M12x1,25	60°	30,0 mm	17 mm	MG27562SU	MG27562SL			
C020	M12x1,5	60°	30,0 mm	17 mm	MG27563SU	MG27563SL			
C030	M14x1,5	60°	30,0 mm	17 mm	MG27564SU	MG27564SL			

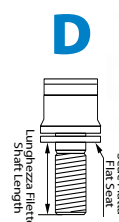

Bulloni Piatti con Rondella - Flat Bolts With Washer

D010	M12x1,25	flat	34,5 mm	17 mm	MG26002SU	MG26002SL	MG26002SUB		MG01002
D020	M12x1,25	flat	34,5 mm	19 mm	MG26001SU	MG26001SL	MG26001SUB		MG01002
D030	M12x1,25	flat	42,2 mm	19 mm	MG26000SU				
D040	M12x1,5	flat	32,3 mm	17 mm	MG26003SU				

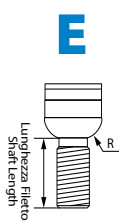

Bulloni Sferici - Spherical Bolts

E010	M12x1,5	R12	20,6 mm	17 mm	MG28176SU				
E020	M12x1,5	R12	24,1 mm	17 mm	MG28028SU	MG28028SL			
E030	M12x1,5	R12	27,9 mm	17 mm	MG28172SU				
E040	M12x1,5	R12	36,0 mm	17 mm	MG28026SU				
E050	M12x1,5	R12	39,9 mm	17 mm	MG28023SU	MG28023SL	MG28023SUB		MG01023
E060	M12x1,5	R12	44,5 mm	17 mm	MG28037SU		MG28037SUB		
E070	M12x1,5	R12	56,0 mm	17 mm	MG28027SU				
E080	M14x1,5	R13	26,7 mm	17 mm	MG28018SU	MG28018SL	MG28018SUB		MG01018
E090	M14x1,5	R14	27,0 mm	17 mm	MG28174SU				
E100	M14x1,5	R12	31,8 mm	17 mm	MG28020SU				
E110	M14x1,5	R12	34,5 mm	17 mm	MG28032SU	MG28032SL	MG28032SUB		
E120	M14x1,5	R12	41,0 mm	17 mm	MG28025SU		MG28025SUB		
E130	M14x1,5	R14	45,0 mm	17 mm	MG28017SU		MG28017SUB		
E140	M14x1,5	R12	48,9 mm	17 mm	MG28042SU				
E150	M14x1,5	R12	53,9 mm	17 mm	MG28043SU				
E160	M14x1,5	R14	31,8 mm	19 mm	MG28177SU				
E170	M14x1,5	R14	37,1 mm	19 mm	MG28044SU		MG28044SUB		



Tipo Type	Dimensione Filetto Thread Size	Sede Seat	Lung. Filetto / Lung. Totale Shaft length / Total Length	Dimensione Chiave Hex Size	Cod. Art. ORIGINAL	Cod. Art. ULTRA HIGHT SECURITY	Cod. Art. BLACK EDITION	Cod. Art. TUNER	Cod. Art. LOK NOX
-----------	--------------------------------	-----------	--	----------------------------	--------------------	--------------------------------	-------------------------	-----------------	-------------------

F

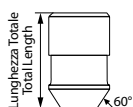

Dadi Conici - Conical Nuts									
F010	1/2x20	60°	32,5 mm	19 mm	MG24193SU		MG24193SUB		
F020	1/2x20	60°	37,0 mm	19 mm	MG24138SU		MG24138SUB		
F030	1/2x20	60°	32,5 mm	21 mm				MG25230SU	
F040	1/2x20	60°	37,0 mm	21 mm	MG24130SU				
F050	7/16"	60°	37,0 mm	19 mm	MG24132SU				
F060	M12x1,25	60°	32,5 mm	19 mm	MG24152SU	MG24152SL			MG01152
	M12x1,25	60°	32,5 mm	19 mm	MG24552SU				
F110	M12x1,25	60°	32,5 mm	21 mm	MG24154SU	MG24154SL		MG25254SU	MG01152
	M12x1,25	60°	32,5 mm	21 mm	MG24557SU			MG25354SU	
F140	M12x1,25	60°/flat	5/32 mm	21 mm	MG24206SU				
F150	M12x1,5	60°	32,5 mm	19 mm	MG24157SU	MG24157SL	MG24157SUB		MG01157
F170	M12x1,5	60°	37,0 mm	19 mm	MG24137SU		MG24137SUB		
	M12x1,5	60°	37,0 mm	19 mm			MG24526SUB		
F200	M12x1,5	60°	32,5 mm	21 mm	MG24195SU	MG24195SL	MG24195SUB	MG25257SU	MG01157
	M12x1,5	60°	32,5 mm	21 mm				MG25357SU	
F220	M12x1,5	60°	37,0 mm	21 mm	MG24238SU				
F230	M14x1,5	60°	39,7 mm	21 mm	MG24214SU	MG24658SL			
F240	M14x1,5	60°	50,0 mm	21 mm	MG24211SU				
F245	M14x1,5	60°	41,8 mm	22 mm				MG25115SU	
F246	M14x1,5	60°	41,8 mm	22 mm				MG25116SU	
F250	M14x1,5	60°	50,0 mm	22 mm	MG24210SU				
F260	M14x1,5	60°	49,1 mm	26 mm				MG25110SU	

Versione contenente 5 dadi. 5 nuts version.
Versione colore nero. Black colour version.

G

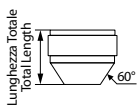

Dadi Conici - Conical Nuts									
Adatti per utilizzo sotto i copri cerchi.					For use under wheel covers, center caps and hub caps.				
G010	1/2x20	60°	19,7 mm	19/21 mm	MG24010SU				
G020	M12x1,25	60°	19,7 mm	19/21 mm	MG24013SU				
G030	M12x1,5	60°/flat	5/32 mm	19 mm	MG24028SU				
G040	M12x1,5	60°	19,7 mm	19/21 mm	MG24012SU				
G050	M12x1,5	60°/flat	5/32 mm	21 mm	MG24022SU				
G060	M14x1,5	60°	22,7 mm	19 mm	MG24018SU				
G070	M14x1,5	60°	22,7 mm	22 mm	MG24019SU				



Tipo Type	Dimensione Filetto Thread Size	Sede Seat	Lung. Filetto / Lung. Totale Shaft length / Total Length	Dimensione Chiave Hex Size	Cod. Art. ORIGINAL	Cod. Art. ULTRA HIGH SECURITY	Cod. Art. BLACK EDITION	Cod. Art. TUNER	Cod. Art. LOK NOX
-----------	--------------------------------	-----------	--	----------------------------	--------------------	-------------------------------	-------------------------	-----------------	-------------------

Dadi Conici con Rondella Flottante - Floating Conical Nuts

H010	M12x1,5	60°	32,5 mm	19 mm	MG24212SU	MG24212SL			
------	---------	-----	---------	-------	-----------	-----------	--	--	--

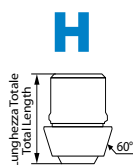

Dadi Piatti - Flat Nuts

Bulloni con diametro sotto testa di **17,2 mm** e lunghezza sotto testa di **14,7 mm**. Contiene rondelle in acciaio inox lucido. **Wheel Locks with a 17,2 mm shank diameter and 14,7 mm shank length. Contains polished stainless steel washer.**

J010	1/2x20	flat	15/35 mm	21 mm	MG21120SU				
J020	M12x1,25	flat	15/35 mm	21 mm	MG21153SU				
J030	M12x1,5	flat	15/35 mm	21 mm	MG21156SU	MG21156SL			
	M12x1,5	flat	15/35 mm	21 mm	MG21556SU	MG21556SL			

Versione contenente 5 dadi.
5 nuts version.

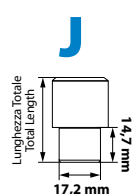

Dadi Piatti - Flat Nuts

Bulloni con diametro sotto testa di **18,5 mm** e lunghezza sotto testa di **8,0 mm**. Contiene rondelle in acciaio inox lucido. **Wheel Locks with a 18,5mm shank diameter and 8,0 mm shank length. Contains polished stainless steel washer.**

K010	M12x1,5	flat	42,2 mm	19mm	MG20116SU				
------	---------	------	---------	------	-----------	--	--	--	--

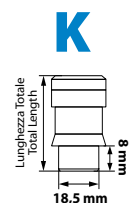

Dadi Piatti - Flat Nuts

Bulloni con diametro sotto testa di **18,5 mm** e lunghezza sotto testa di **19,4 mm [L010] e 10 mm [L020]**. Contiene rondelle in acciaio inox lucido. **Wheel Locks with a 18,5mm shank diameter and 19,4 mm [L010] - 10 mm [L020] shank length. Contains polished stainless steel washer.**

L010	M14x1,5	flat	19,4/42,6 mm	22 mm	MG21157SU				
L020	M14x1,5	flat	19,4/40,8 mm	22 mm	MG21158SU				

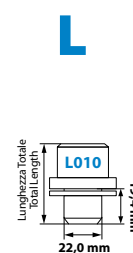

Dadi sferici - Spherical Nuts

M010	M12x1,5	R12	30,0 mm	19 mm	MG25000SU	MG25000SL			
	M12x1,5	R12	30,0 mm	19 mm	MG25002SU				
M030	M14x1,5	R14	22,7 mm	19 mm	MG25167SU				

Versione contenente 5 dadi.
5 nuts version.

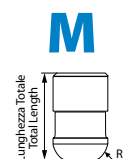

LOCANDINA AUTOPORTANTE

In cartone, con supporto da appoggio

STAND-ALONE CARDBOARD DISPLAY BOARD

MG99998 30x30 cm

Sfuso / Bulk ☐ 1



LOCANDINA POP-UP

Con estensore e base adesiva

ADHESIVE BASE POP-UP CARDBOARD DISPLAY

MG99999 15x27 cm

Sfuso / Bulk ☐ 1



Ordinare le chiavi di ricambio... è diventato facile!!!

Ordering replacement keys... made easy!!!



Il modo più semplice per ordine o richiedere le chiavi di ricambio è via web-shop:

The easiest way to order a McGard replacement key is via our web-shop:

shop.mcgard.de

Potete ordinare la chiave di ricambio on-line inserendo il codice a 17/18 cifre, che trovate sulle istruzioni incluse in ogni confezione di bulloni antifurto McGard.

Entering the 17/18 digit code number, which you will find printed in the installation instruction of each McGard wheel lock set, you can order the right replacement key very easily online.

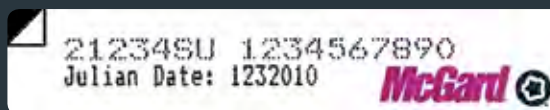

In alternativa potete ordinare via posta, via e-mail, via fax oppure al telefono tramite i seguenti contatti:

Of course you can also contact us in written form, by e-mail, by fax or by phone. Please use the following contact details:



McGard Deutschland GmbH
 Nordstrae 12
 D-74226 Nordheim
 Phone: +49 (0)7133 901-0
 Telefax: +49 (0)7133 901932
 e-mail: cs@mcgard.de

Servizio Hotline / Our Service-Hotline
00800 25 99 34 00

gratuito per: / free of charge for:
D - F - I - E - NL - S - P - PL

Precisiamo inoltre che, se non siete in possesso dei codici numerici potete inviate la foto della testa del bullone antifurto all'indirizzo: cs@mcgard.de e noi individueremo il codice corretto per voi.

If you do not have the 17/18 digit code number for the McGard wheel locks, please send us a digital photo of the pattern groove, this is formed in the head of the nut or bolt (flower-form) to cs@mcgard.de and we will find the right code for you.

Distanziali



KIT DISTANZIALI "SPECIFICI"

Prodotti in lega di alluminio e lavorati ad altissima precisione per ottenere un prodotto affidabile e durevole nel tempo. I distanziali Pilot sono ricavati da barra piena di alluminio di alta qualità e lavorati con macchinari ad altissima precisione al fine di assicurare un montaggio "su misura" per vari modelli di vetture. Il kit comprende due distanziali specifici e per le vetture che lo prevedono, due viti per il fissaggio dei distanziali al mozzo ruota. I bulloni devono essere ordinati a parte.

CUSTOM-FIT WHEEL SPACERS

Manufactured using high quality aluminium alloy and precision-tooled to ensure a top performance product. Pilot wheel spacers are obtained from solid aluminium alloy bar and tooled by precision machinery to custom-fit each specific car model. Kit includes 2 spacers and 2 screws for fitting spacers onto the hub-cap (only for cars which require it). The bolts must be ordered separately.

Scatola / Box 5

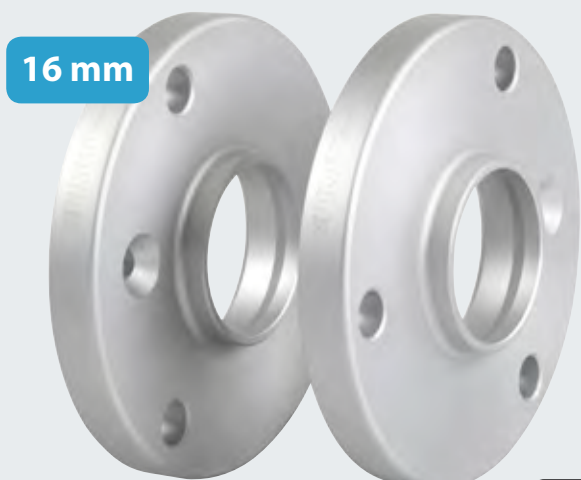

16 mm

2
pcs



20 mm

2
pcs



16 mm		20 mm		Fori Holes	Interasse bulloni PCD	Foro centr. NLB Centre bore	Ø Foro Hole
Cod.	Tg / Size	Cod.	Tg / Size				
48550	A0	48600	B0	3	112	57,1	12
48551	A1	48601	B1	4	98	58,1	12
48552	A2	48602	B2	4	98	58,6	12
48553	A3	48603	B3	5	100	54,1	12
48554	A4	48604	B4	4	100	54,1	12
48555	A5	48605	B5	4	100	56,1	12
48556	A6	48606	B6	4	100	56,6	12
48557	A7	48607	B7	4	100	57,1	12
48558	A8	48608	B8	4	100	59,1	12
48559	A9	48609	B9	4	100	60,1	12
48560	A10	48610	B10	4	108	63,4	12
48561	A11	48611	B11	4	108	65,1	12
48562	A12	48612	B12	4	114	66,1	12
48563	A13	48613	B13	4	114	67,1	12
48564	A14	48614	B14	5	98	58,1	12
48565	A15	48615	B15	5	98	58,1	14
48566	A16	48616	B16	4	100	52,1	12
48567	A17	48617	B17	5	100	56,1	12
48568	A18	48618	B18	5	100	57,1	14
48569	A19	48619	B19	5	108	58,1	12
48570	A20	48620	B20	5	108	60,1	14
48571	A21			5	108	65,1	12
48572	A22	48622	B22	5	108	65,1	14
48573	A23	48623	B23	5	110	65,1	12
48574	A24	48624	B24	5	112	57,1	14
48575	A25	48625	B25	5	112	66,6	12
48576	A26	48626	B26	5	112	66,6	14
48577	A27	48627	B27	5	114	66,1	12
48578	A28	48628	B28	5	114,3	67,1	12
48579	A29	48629	B29	5	120	72,6	12
48580	A30	48630	B30	5	120	72,6	14
48581	A31	48631	B31	5	120	74,1	12
48582	A32	48632	B32	4	100	56,1	12
48583	A33	48633	B33	5	130	71,6	14
48585	A35			5	120	74,1	14
48586	A36	48636	B36	5	108	63,3	12
48587	A37	48637	B37	4	100	56,1	14

Distanziali 4x4



KIT DISTANZIALI DA 30 MM "SPECIFICI" PER VETTURE FUORISTRADA.

COMPLETI DI BULLONERIA CROMATA

Prodotti in lega di alluminio e lavorati ad altissima precisione per ottenere un prodotto affidabile e durevole nel tempo.

I distanziali Pilot sono ricavati da barra piena di alluminio di alta qualità e lavorati con macchinari ad altissima precisione al fine di assicurare un montaggio "su misura" per vari modelli di vetture.

Il kit comprende due distanziali specifici completi di tutta la bulloneria necessaria per il montaggio

30 MM CUSTOM-FIT WHEEL SPACERS FOR 4X4 COMPLETE WITH CHROMED FITTING BOLTS AND NUTS

Manufactured using high quality aluminium alloy and precision-tooled to ensure a top performance product. Pilot wheel spacers are obtained from solid aluminium alloy bar and tooled by precision machinery to custom-fit each specific car model.

Scatola / Box 4

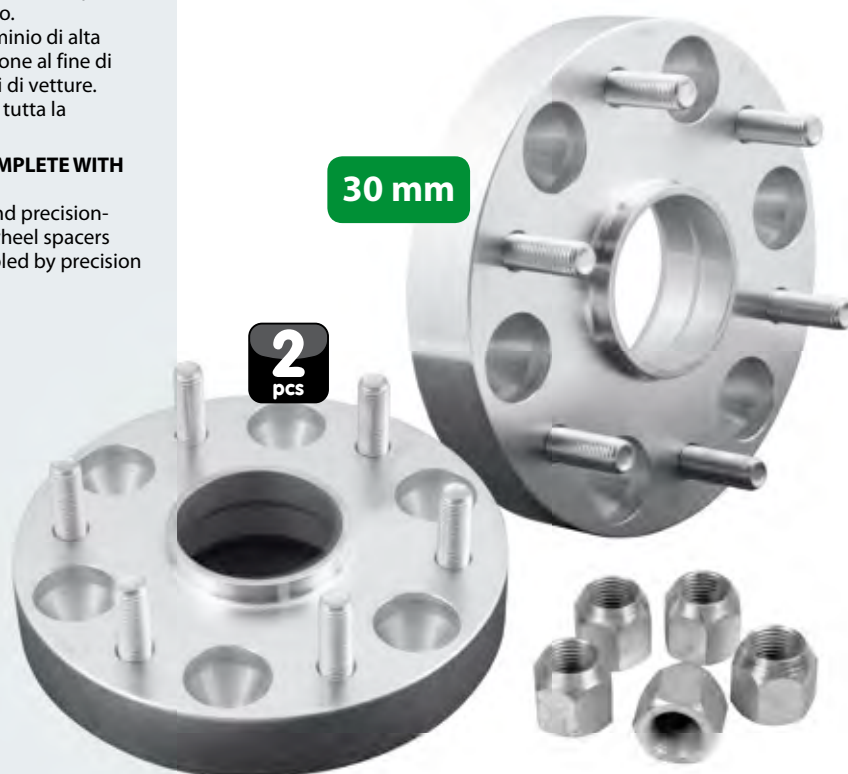

**Bulloni inclusi
Bolts & nuts
included**

30 mm		Fori Holes	Interasse bulloni PCD	Foro centr. NLB Centre bore	Ø Foro Ø Hole
Cod.	Tg / Size				
48700	M0	5	114	71,6	1/2" UNF
48703	M3	5	127	71,2	1/2" UNF
48706	M6	5	114	71,4	12x1,50
48709	M9	6	139	108,5	12x1,50
48712	M12	5	139,7	108	12x1,50
48715	M15	5	114,3	67,1	12x1,50
48718	M18	5	139	95,5	12x1,50
48724	M24	5	120	70	14x1,50
48727	M27	5	114	64	12x1,50
48730	M30	5	112	66,6	14x1,50
48733	M33	6	139	67,1	12x1,50
48739	M39	6	139	108	12x1,25
48745	M45	6	139	108	12x1,50
48748	M48	5	139	108	12x1,25
48751	M51	5	114	60,1	12x1,50



BULLONERIA PER DISTANZIALI DA 16 E 20 MM

Prodotti in lega speciale di acciaio 10.9 con finitura zincata. Kit da 10 pezzi.







CHROME BOLTS FOR 16/20 MM WHEEL SPACERS

10.9 galvanized alloy steel. Set of 10 pcs

D/Blister 20

Bulloneria per distanziali

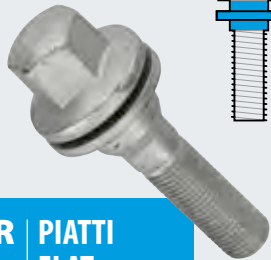

<p>BULLONI CONICI CONICAL BOLTS</p>   <p>TC CONICI CC CONICAL</p>	<p>BULLONI SFERICI SPHERICAL BOLTS</p>   <p>TS SFERICI SPHERICAL</p>	<p>BULLONI PIATTI CON RONDELLA FLAT BOLTS WITH WASHER</p>   <p>PR PIATTI FLAT</p>	<p>PRIGIONIERI MILLE RIGHE SPLINE WHEEL STUDS</p>   <p>MR MILLERIGHE STUDS</p>
---	--	--	--



DOPPIO BLISTER DOUBLE BLISTER

10 pcs SET

D/Blister 20



BUSTA BAG

10 pcs SET

Busta / Bag 20

Originale			Testa Head (mm)	Sede Seat	Filetto Thread (mm)	Lunghezza Length
D/BLISTER	BUSTA/BAG	Tg / Size				
48800	48860	TC0	19	60°	M12x1,25	46
48801	48861	TC1	17	60°	M12x1,25	45
48802	48862	TC2	17	60°	M12x1,5	45
48804	48863	TC4	17	60°	M14x1,5	45
48805	48864	TC5	19	60°	M12x1,25	50
48806	48865	TC6	17	60°	M12x1,25	50
48807	48866	TC7	17	60°	M12x1,5	50
48809	48867	TC9	17	60°	M14x1,5	50
48825	48874	TC10	17	60°	M14x1,25	43
48826	48875	TC11	17	60°	M14x1,25	50
48811	48868	TS1	17	R12	M12x1,5	45
48812	48869	TS2	17	R12	M14x1,5	45
48813	48870	TS3	17	R12	M14x1,5	50
48814	48871	TS4	17	R12	M12x1,5	60
48815	48872	TS5	17	R12	M14x1,5	60
48828	48876	TS6	19	R14	M14x1,5	53
48829	48877	TS7	19	R14	M14x1,5	58
48820	48873	PR0	17	Flat	M12x1,25	35
48830	48878	MR0		12,4	M12x1,5	62
48832	48879	MR2		13	M12x1,5	55
48833	48880	MR3		13	M12x1,5	62
48834	48881	MR4		14,3	M12x1,5	57
48835	48882	MR5		14,3	M12x1,5	62
48838	48883	MR8		14,3	M12x1,25	62

Aftermarket			Testa Head (mm)	Sede Seat	Filetto Thread (mm)	Lunghezza Length
D/BLISTER	BUSTA/BAG	Tg / Size				
48817	48885	CC0	17	60°	M12x1,5	28
48818	48886	CC1	17	60°	M12x1,5	32
48819	48887	CC2	19	60°	M12x1,25	28
48827		TC12	17	60°	M14x1,25	66
48810	48884	TS0	17	R12	M14x1,5	27





Kit Ruotino di Scorta

Compact Spare Wheel Kit



NO-STOP, KIT RUOTINO DI SCORTA

Indispensabile in caso di lacerazione o squarcio dello pneumatico su vetture provviste solo del kit riparazione pneumatici che in questi casi risulta inefficace. Il ruotino permette di raggiungere il gommista/officina più vicino senza dover ricorrere al carro attrezzi, può essere riutilizzato più volte per brevi percorrenze con una velocità massima consentita di 80 km/h. Le dimensioni ridotte permettono di riporlo in pochissimo spazio e grazie alla pratica sacca può essere posizionato all'interno del veicolo senza un vano dedicato alla ruota di scorta, oppure in veicoli con il vano occupato dalla bombola del GPL. Il kit è composto da una ruota già montata sul cerchio ed equilibrata (solitamente di dimensioni più piccole rispetto agli pneumatici montati sull'auto) un cric, una chiave per svitare i bulloni ed una sacca in tessuto

NO-STOP, COMPACT SPARE WHEEL KIT

Essential for all vehicles equipped only with tyre repair kit which is useless in case of torn tyres or deep cuts. The compact spare wheel kit allows you to reach the nearest tyre shop without calling the road side assist ance, it can be re-used several times for short journeys and with a maximum speed of 80 km/h. The small size allows you to store it in very little space and thanks to the practical bag it can be placed inside the vehicles without the spare wheel compartment, or in vehicles with the compartment occupied by the LPG. The kit consists of a wheel already mounted on the rim and balanced (usually smaller in size than tires fitted to the car), a jack, a key to unscrew the bolts and a fabric bag

Cartone / Carton 1

Il kit contiene:

- 1 ruotino completo di cerchio e pneumatico già montato.
- 1 cric dedicato per il veicolo.
- 1 chiave svita bulloni.
- 1 sacca in tessuto resistente.

e per veicoli che lo necessitano:

- 1 anello di centraggio
- 1 kit bulloni

Kit contains:

- 1 compact spare wheel with tyre already mounted.
- 1 jack specific for the vehicle.
- 1 key to unscrew bolts.
- 1 fabric bag.

and for vehicles that need it:

- 1 centering ring
- 1 bolts kit



Ø
15" - 16" - 17"



ACCIAIO / STEEL

Ø
16" - 17" - 18"



LEGA / ALLOY

★ TOP TEN

10 articoli che coprono circa il 60% del venduto in Italia.
(ideali per realizzare un assortimento di base)

	Codice Code	Pneumatico Tyre	Materiale Material	Ø	Canale Width	Offset ET	Fori x Int. PCD	Foro Centr. Hole	Tipo centraggio Centering type	Viti Screws	Cric	Chiave Key
★	76000	115/70-15	Acciaio	15	4j	20	4x98	58	specifico	originali	Pantografo	17
	76001	115/70-15	Acciaio	15	4j	35	4x100	60	anello	originali	Pantografo	19
	76002	115/70-15	Acciaio	15	4j	35	4x100	60	specifico	originali	Pantografo	17
★	76003	115/70-15	Acciaio	15	4j	35	4x100	60	anello	originali	Pantografo	17
	76004	115/70-15	Acciaio	15	4j	35	4x100	60	anello	originali	Pantografo	19
★	76005	115/70-15	Acciaio	15	4j	35	4x100	60	anello	originali	Pantografo	21
	76006	115/70-15	Acciaio	15	4j	35	4x100	60	specifico	originali	Pantografo	17
	76007	115/70-15	Acciaio	15	4j	35	4x100	60	specifico	originali	Pantografo	21
	76008	115/70-15	Acciaio	15	4j	35	4x100	60	anello	originali	Pantografo	17
	76009	115/70-15	Acciaio	15	4j	35	4x100	60	anello	originali	Pantografo	19
	76010	115/70-15	Acciaio	15	4j	35	4x100	60	anello	originali	Pantografo	17
	76011	115/70-15	Acciaio	15	4j	35	4x100	60	anello	originali	Pantografo	17

	Code Code	Pneumatico Tyre	Materiale Material	∅	Canale Width	Offset ET	Fori x Int. PCD	Foro Centr. Hole	Tipo centraggio Centering type	Viti Screws	Cric	Chiave Key
	76012	115/70-15	Acciaio	15	4j	12	5x100	57	specifico	originali	Pantografo	17
	76013	115/70-15	Acciaio	15	4j	12	5x100	57	anello	dadi 12x1.50 T 21	Idraulico	21
	76014	115/70-15	Acciaio	15	4j	20	4x98	58	specifico	originali	Pantografo	17
	76015	115/70-15	Acciaio	15	4j	20	4x108	63,4	specifico	originali	Pantografo	19
	76016	115/70-15	Acciaio	15	4j	20	4x108	63,4	specifico	originali	Pantografo	19
	76017	115/70-15	Acciaio	15	4j	35	4x100	60	anello	originali	Pantografo	19
	76018	125/70-16	Acciaio	16	4j	20	4x100	60	anello	originali	Pantografo	21
	76019	125/70-16	Acciaio	16	4j	20	4x100	60	anello	originali	Pantografo	17
	76020	125/70-16	Acciaio	16	4j	20	4x100	60	anello	originali	Pantografo	19
	76021	125/70-16	Acciaio	16	4j	20	4x100	60	specifico	originali	Pantografo	17
	76022	125/70-16	Acciaio	16	4j	20	4x100	60	specifico	originali	Pantografo	17
	76023	125/70-16	Acciaio	16	4j	20	4x100	60	anello	originali	Pantografo	19
	76024	125/70-16	Acciaio	16	4j	20	4x100	60	anello	originali	Pantografo	21
	76025	125/70-16	Acciaio	16	4j	20	4x100	60	anello	originali	Pantografo	17
	76026	125/70-16	Acciaio	16	4j	20	4x100	60	anello	originali	Pantografo	19
	76027	125/70-18	Lega	18	4j	0	5x110	65	specifico	originali	Pantografo	17
	76028	125/70-18	Lega	18	4j	0	5x112	66,6	specifico	originali	Pantografo	17
	76029	125/70-18	Lega	18	4j	0	4x108	65	specifico	originali	Pantografo	17
	76030	125/70-18	Lega	18	4j	0	4x108	65	specifico	originali	Idraulico	17
	76031	125/70-18	Lega	18	4j	10	5x100	56	specifico	originali	Idraulico	19
	76032	125/70-18	Lega	18	4j	10	5x108	63,4	specifico	originali	Pantografo	19
★	76033	125/80-16	Acciaio	16	4j	0	5x98	58	specifico	originali	Pantografo	17
	76034	125/80-16	Acciaio	16	4J	20	4x100	60	specifico	originali	Pantografo	17
	76035	125/80-16	Acciaio	16	4j	35	4x100	60	anello	originali	Pantografo	19
	76036	125/80-16	Acciaio	16	4j	20	4x100	60	specifico	originali	Pantografo	17
	76037	125/80-16	Acciaio	16	4j	20	4x100	60	specifico	originali	Pantografo	17
	76038	125/80-16	Acciaio	16	4j	20	4x100	60	anello	originali	Pantografo	21
	76039	125/80-16	Acciaio	16	4j	20	4x100	60	anello	originali	Pantografo	19
★	76040	125/80-17	Acciaio	17	4j	18	5x112	66,6	anello	originali	Pantografo	17
★	76041	125/80-17	Acciaio	17	4j	18	5x112	66,6	specifico	originali	Pantografo	17
	76042	125/80-17	Acciaio	17	4j	18	5x112	66,6	specifico	vite sferica 14x1.25	Pantografo	17
★	76043	125/80-17	Acciaio	17	4j	10	5x120	72,6	specifico	originali	Pantografo	17
	76044	125/80-17	Acciaio	17	4j	10	5x120	72,6	anello	originali	Pantografo	23
	76045	125/80-17	Acciaio	17	4j	20	5x114,3	70,2	specifico	originali	Pantografo	19
	76046	125/80-17	Acciaio	17	4j	20	5x114,3	70,2	anello	originali	Idraulico	17
	76047	125/80-17	Acciaio	17	4j	20	5x114,3	70,2	anello	originali	Idraulico	17
	76048	125/80-17	Acciaio	17	4j	20	5x114,3	70,2	anello	originali	Pantografo	17
	76049	125/80-17	Acciaio	17	4j	20	5x114,3	70,2	anello	originali	Pantografo	19
	76050	125/80-17	Acciaio	17	4j	20	5x114,3	70,2	anello	originali	Pantografo	21
	76051	125/80-17	Acciaio	17	4j	20	5x114,3	70,2	anello	originali	Idraulico	21
	76052	125/80-17	Acciaio	17	4j	20	5x114,3	70,2	anello	originali	Pantografo	19
	76053	125/80-17	Acciaio	17	4j	20	5x114,3	70,2	anello	originali	Pantografo	17
★	76054	125/80-17	Acciaio	17	4j	10	5x110	63,4	anello	vite flottante 12x1.25	Pantografo	17
	76055	125/80-17	Acciaio	17	4j	10	5x108	63,4	specifico	originali	Pantografo	17
★	76056	125/80-17	Acciaio	17	4j	10	5x108	63,4	anello	originali	Pantografo	19
★	76057	125/80-17	Acciaio	17	4j	5	5x105	56,6	specifico	originali	Idraulico	19
	76058	125/80-17	Acciaio	17	4j	20	5x114,3	70,2	anello	originali	Pantografo	19
	76059	125/80-17	Acciaio	17	4j	10	5x108	63,4	anello	vite flottante 12x1.50	Pantografo	17
	76060	125/80-17	Acciaio	17	4j	10	5x108	63,4	anello	originali	Pantografo	19
	76061	125/80-17	Lega	17	4j	0	5x110	65	specifico	originali	Pantografo	17
	76062	125/80-17	Lega	17	4j	0	5x112	57	specifico	originali	Pantografo	17
	76063	125/80-17	Lega	17	4j	0	5x112	66,6	specifico	originali	Pantografo	17
	76064	125/80-17	Lega	17	4j	0	5x120	72,6	specifico	originali	Pantografo	17
	76066	125/80-17	Lega	17	4j	0	4x108	65	specifico	originali	Pantografo	17
	76067	125/80-17	Lega	17	4j	10	5x108	63,4	specifico	originali	Pantografo	19
	76068	125/80-17	Lega	17	4j	10	4x108	63,4	specifico	originali	Idraulico	19
	76069	125/80-17	Lega	17	4j	10	5x114,3	67	specifico	originali	Pantografo	21
	76070	125/80-17	Lega	17	4j	0	5x112	66,6	specifico	vite sferica 14x1.25	Pantografo	17
	76071	125/80-17	Lega	17	4j	10	5x100	56	specifico	originali	Idraulico	19
	76073	125/80-17	Lega	17	4j	0	5x100	54	specifico	originali	Pantografo	21
	76074	125/80-17	Lega	17	4j	0	5x98	58	specifico	originali	Idraulico	17
	76075	125/80-17	Acciaio	17	4j	20	5x114,3	70,2	anello	originali	Pantografo	21
	76076	145/80-18	Lega	18	4j	0	5x112	66,6	specifico	originali	Pantografo	17

Codice Code	Pneumatico Tyre	Materiale Material	∅	Canale Width	Offset ET	Fori x Int. PCD	Foro Centr. Hole	Tipo centraggio Centering type	Viti Screws	Cric	Chiave Key
76077	145/80-18	Lega	18	4j	0	5x120	72,6	specifico	originali	Pantografo	17
76078	145/80-18	Lega	18	4j	0	5x110	65	specifico	originali	Idraulico	19
76079	145/80-18	Lega	18	4j	10	5x114,3	60	specifico	originali	Idraulico	21
76080	145/80-18	Lega	18	4j	10	5x114,3	60	specifico	originali	Pantografo	21
76081	145/80-18	Lega	18	4j	10	5x114,3	60	specifico	originali	Pantografo	17
76082	145/80-18	Lega	18	4j	10	5x100	56	specifico	originali	Idraulico	19
76083	145/80-18	Lega	18	4j	10	5x108	63,4	specifico	originali	Pantografo	19
76084	155/70-17	Acciaio	17	4j	10	5x108	63,4	anello	originali	Pantografo	19
76085	155/70-17	Lega	17	4j	0	5x112	66,6	specifico	originali	Pantografo	17
76086	155/70-17	Lega	17	4j	0	5x120	72,6	specifico	originali	Pantografo	17
76087	155/85-18	Lega	18	4j	0	5x120	72,6	specifico	originali	Idraulico	17
76088	155/85-18	Lega	18	4j	10	5x127	71,6	specifico	originali	Idraulico	19
76089	155/85-18	Lega	18	4j	10	5x108	63,4	specifico	originali	Idraulico	19
76090	155/85-18	Lega	18	4j	10	5x114,3	60	specifico	originali	Idraulico	21
76091	155/85-18	Lega	18	4j	0	5x112	66,6	specifico	originali	Idraulico	17
76092	155/85-18	Lega	18	4j	0	5x110	65	specifico	originali	Idraulico	17
76093	155/85-18	Lega	18	4j	0	5x112	66,6	specifico	originali	Idraulico	17
76094	155/85-18	Lega	18	4j	10	5x108	63,4	specifico	originali	Idraulico	19
76095	155/85-18	Lega	18	4j	10	5x130	71,6	specifico	originali	Idraulico	17
76096	155/85-18	Lega	18	4j	10	5x108	63,4	specifico	originali	Idraulico	21
76097	155/85-18	Lega	18	4j	10	5x127	71,6	specifico	originali	Idraulico	19
76098	155/85-18	Lega	18	4j	10	5x114,3	67	specifico	originali	Idraulico	19
76099	155/85-18	Lega	18	4j	0	5x120	74	specifico	originali	Idraulico	17
76100	155/85-18	Lega	18	4j	0	5x120	72,6	specifico	originali	Idraulico	21
76101	155/90-17	Acciaio	17	4j	20	5x114,3	70,2	anello	originali	Pantografo	19
76102	155/90-17	Acciaio	17	4j	18	5x112	66,6	specifico	originali	Idraulico	17
76103	155/90-17	Acciaio	17	4j	10	5x120	72,6	specifico	originali	Idraulico	17
76104	155/90-17	Acciaio	17	4j	20	5x114,3	70,2	anello	originali	Idraulico	21
76105	155/90-17	Acciaio	17	4j	20	5x114,3	70,2	anello	originali	Idraulico	21
76106	155/90-17	Acciaio	17	4j	20	5x114,3	70,2	specifico	originali	Idraulico	19
76107	155/90-17	Acciaio	17	4j	20	5x114,3	70,2	anello	originali	Idraulico	17
76108	155/90-17	Acciaio	17	4j	20	5x114,3	70,2	anello	originali	Idraulico	19
76109	155/90-17	Acciaio	17	4j	20	5x114,3	70,2	anello	originali	Idraulico	21
76110	155/90-17	Acciaio	17	4j	20	5x114,3	70,2	anello	originali	Idraulico	19
76111	155/90-17	Lega	17	4j	18	5x112	66,6	anello	originali	Idraulico	17
76112	155/90-17	Acciaio	17	4j	10	5x108	63,4	anello	originali	Pantografo	19
76113	155/90-17	Acciaio	17	4j	10	5x108	63,4	specifico	originali	Idraulico	19
76114	155/90-17	Lega	17	4j	0	5x112	66,6	specifico	originali	Idraulico	17
76115	155/90-17	Lega	17	4j	10	5x127	71,6	specifico	originali	Idraulico	19
76117	155/90-17	Lega	17	4j	10	5x108	63,4	specifico	originali	Idraulico	21
76118	155/90-17	Lega	17	4j	10	5x114,3	67	anello	originali	Idraulico	21
76119	155/90-17	Lega	17	4j	10	5x100	56	specifico	originali	Idraulico	19
76120	155/90-17	Lega	17	4j	0	5x108	65	specifico	originali	Idraulico	17
76121	155/90-17	Lega	17	4j	0	5x110	65	specifico	originali	Idraulico	17
76122	125/80-16	Lega	16	4j	0	5x110	60	specifico	originali	Pantografo	17

★ **TOP TEN**
 10 articoli che coprono circa il 60% del venduto in Italia.
 (ideali per realizzare un assortimento di base)

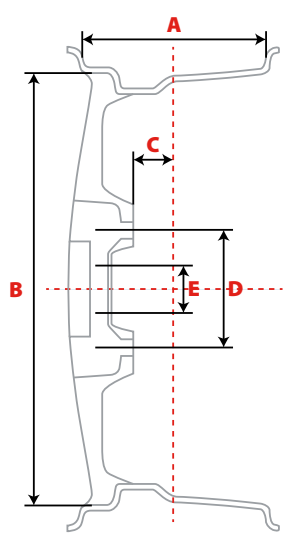

- A - Larghezza del canale.
- B - Diametro di calettamento in pollici.
- C - Offset o ET del cerchio in mm.
- D - PCD o numero ed interasse dei fori di fissaggio del cerchio.
- E - Diametro foro di centraggio