



STYLING

SPECCHI RETROVISORI
MANOPOLE
STABILIZZATORI
PORTATARGA
DECORAZIONI



12 REAR VIEW MIRRORS
22 GRIPS
23 BAR ENDS
24 PLATE HOLDERS
28 DECORATIONS

Specchi retrovisori rearview mirrors



CLASSIC, COPPIA SPECCHI RETROVISORI

- Snodo regolabile.
- Attacco a manubrio.
- Filettatura destra M10x1,25.
- Omologati.

CLASSIC, PAIR OF REARVIEW MIRRORS

- Adjustable.
- Handlebar fitting.
- Right thread M10x1,25.
- Approved.

90490

Scatola / Box 5 / 30



Classic

2
pcs

SX + **DX**

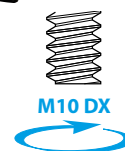

MARPH, COPPIA SPECCHI RETROVISORI

- Snodo regolabile.
- Attacco a manubrio.
- Filettatura destra M10x1,25.
- Omologati.

MARPH, PAIR OF REARVIEW MIRRORS

- Adjustable.
- Handlebar fitting.
- Right thread M10x1,25.
- Approved.

90487

Scatola / Box 5 / 30



Snodo regolabile
Adjustable mirrors



Marph

2 pcs

SX + DX

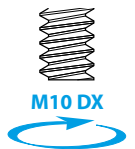

JAX, COPPIA SPECCHI RETROVISORI

- Snodo regolabile.
- Attacco a manubrio.
- Filettatura destra M10x1,25.
- Omologati.

JAX, PAIR OF REARVIEW MIRRORS

- Adjustable.
- Handlebar fitting.
- Right thread M10x1,25.
- Approved.

90488

Scatola / Box 5 / 30

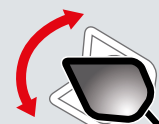

Snodo regolabile
Adjustable mirrors



Jax

2 pcs

SX + DX

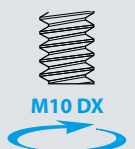

Inclinazione regolabile
Adjustable angle



Inclinazione regolabile
Adjustable angle

FENDER, COPPIA SPECCHI RETROVISORI

- Snodo regolabile.
- Attacco a manubrio.
- Filettatura destra M10x1,25.
- Omologati.

FENDER, PAIR OF REARVIEW MIRRORS

- Adjustable.
- Handlebar fitting.
- Right thread M10x1,25.
- Approved.

90489

Scatola / Box 5 / 30



Fender

2
pcs
SX + DX

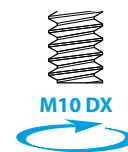

BORG, COPPIA SPECCHI RETROVISORI

- Snodo regolabile.
- Attacco a manubrio.
- Filettatura destra M10x1,25.
- Omologati.

BORG, PAIR OF REARVIEW MIRRORS

- Adjustable.
- Handlebar fitting.
- Right thread M10x1,25.
- Approved.

90486

Scatola / Box 5 / 30



Borg

2
pcs
SX + DX

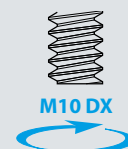

SPACE, COPPIA SPECCHI RETROVISORI

- Snodo regolabile.
- Attacco a manubrio.
- Filettatura destra M10x1,25.
- Omologati.

SPACE, PAIR OF REARVIEW MIRRORS

- Adjustable.
- Handlebar fitting.
- Right thread M10x1,25.
- Approved.

90080

Scatola / Box 5 / 30



Space

2 pcs

SX + DX



Snodo regolabile
Adjustable mirrors

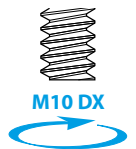

LIMITS, COPPIA SPECCHI RETROVISORI

- Snodo regolabile.
- Attacco a manubrio.
- Filettatura destra M10x1,25.
- Omologati.

LIMITS, PAIR OF REARVIEW MIRRORS

- Adjustable.
- Handlebar fitting.
- Right thread M10x1,25.
- Approved.

90081

Scatola / Box 5 / 30



Limits

2 pcs

SX + DX



Snodo regolabile
Adjustable mirrors

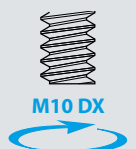

KABA, COPPIA SPECCHI MOTO

- Snodo regolabile.
- Attacco a manubrio.
- Filettatura destra M10x1,25.
- Omologati.

KABA, PAIR OF REARVIEW MIRRORS

- Adjustable.
- Handlebar fitting.
- Right thread M10x1,25.
- Approved.

90346

Scatola / Box 5 / 30



Kaba

2
pcs

SX + **DX**

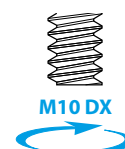

DIKE, COPPIA SPECCHI MOTO

- Snodo regolabile.
- Attacco a manubrio.
- Filettatura destra M10x1,25.
- Omologati.

DIKE, PAIR OF REARVIEW MIRRORS

- Adjustable.
- Handlebar fitting.
- Right thread M10x1,25.
- Approved.

90347

Scatola / Box 5 / 30



Dike

2
pcs

SX + **DX**

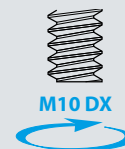

TORI, COPPIA SPECCHI MOTO

- Snodo regolabile.
- Attacco a manubrio.
- Filettatura destra M8x1,25.
- Omologati.

TORI, PAIR OF REARVIEW MIRRORS

- Adjustable.
- Handlebar fitting.
- Right thread M8x1,25.
- Approved.

90344

Scatola / Box  5 / 30



Snodo regolabile
Adjustable mirrors

Tori

2
pcs

SX + **DX**

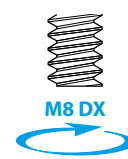

VINK, COPPIA SPECCHI MOTO

- Snodo regolabile.
- Attacco a manubrio.
- Filettatura destra M10x1,25.
- Omologati.

VINK, PAIR OF REARVIEW MIRRORS

- Adjustable.
- Handlebar fitting.
- Right thread M10x1,25.
- Approved.

90345

Scatola / Box  5 / 30



Snodo regolabile
Adjustable mirrors

Vink

2
pcs

SX + **DX**

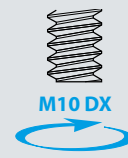

KIRO, COPPIA SPECCHI MOTO

- Snodo regolabile.
- Attacco a manubrio.
- Filettatura destra M10x1,25.
- Omologati.

KIRO, PAIR OF REARVIEW MIRRORS

- Adjustable.
- Handlebar fitting.
- Right thread M10x1,25.
- Approved.

90430

Scatola / Box 5 / 30



(E)



Snodo regolabile
Adjustable mirrors

2
pcs

SX + **DX**

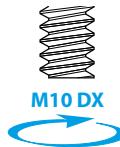

Kiro

HORIZON EVO, COPPIA SPECCHI MOTO

- Snodo regolabile.
- Attacco a manubrio.
- Filettatura destra M10x1,25.
- Omologati.

HORIZON EVO, PAIR OF REARVIEW MIRRORS

- Adjustable.
- Handlebar fitting.
- Right thread M10x1,25.
- Approved.

90431

Scatola / Box 5 / 30



2
pcs

SX + **DX**



Snodo regolabile
Adjustable mirrors

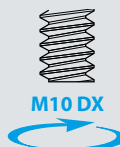

(E)

Horizon EVO

TRAX, COPPIA SPECCHI MOTO

- Snodo regolabile.
- Attacco a manubrio.
- Filettatura destra M10x1,25.
- Omologati.

TRAX, PAIR OF REARVIEW MIRRORS

- Adjustable.
- Handlebar fitting.
- Right thread M10x1,25.
- Approved.

90432

Scatola / Box 5 / 30



INFINITY, COPPIA SPECCHI RETROVISORI

- Snodo regolabile
- Braccio in lega leggera
- Attacco a manubrio
- Filettatura destra M10x1,25.
- Omologati

INFINITY, PAIR OF REARVIEW MIRRORS

- Adjustable
- Aluminium alloy material
- Handlebar fitting
- Right thread M10x1,25.
- Approved

90129

Scatola / Box 5 / 30



HORIZON, COPPIA SPECCHI RETROVISORI

- Snodo regolabile
- Attacco a manubrio
- Filettatura destra M8x1,25
- Omologati

HORIZON, PAIR OF REARVIEW MIRRORS

- Adjustable
- Handlebar fitting
- Right thread M8x1,25
- Approved

90128

Scatola / Box 5 / 30



Horizon

2
pcs

SX + **DX**



NAKED, COPPIA SPECCHI RETROVISORI

Filettatura destra M10x1,25.

NAKED, PAIR OF REARVIEW MIRRORS

Right thread M10x1,25.

90131

Carbon Carbon

Scatola / Box 5 / 30

Non omologati per uso stradale
Not approved for road use



Naked

2
pcs

SX + **DX**





1 pc

Alluminio
Aluminium

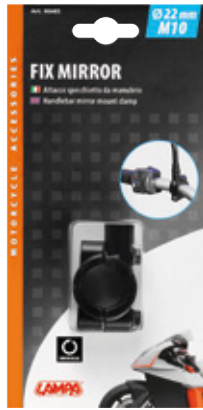

FIX MIRROR, ATTACCO SPECCHIETTO DA MANUBRIO

Per manubri Ø 22 mm, filettatura specchio M10 destro

FIX MIRROR, HANDLEBAR MIRROR MOUNT CLAMP

Suitable for Ø 22 mm handlebar, M10 right mirror thread

90485

Blister 10 / 100



ADATTATORE PER SPECCHI MOTO

Filettatura passo 1,25 mm

MIRROR ADAPTERS

Thread pitch 1,25 mm

90137	M10 DX > M10 SX
90138	M10 DX > M10 DX
90139	M10 DX > M8 DX
90140	M10 DX > M8 SX
90150	M8 DX > M10 DX
90151	M8 DX > M10 SX



D/Blister 10 / 100



TABELLA APPLICAZIONE MOTO

Aprilia	M10 DX	M10 DX - SX
Bmw	M10 DX - M8 DX	M10 DX - M8 DX
Cagiva	M10 DX	M10 DX
Ducati	M10 DX	M10 DX - SX
Honda	M10 DX	M10 DX
Kawasaki	M10 DX	M10 DX
Moto Guzzi	M10 DX	M10 DX
Suzuki	M10 DX	M10 DX
Triumph	M10 DX	M10 DX
Yamaha	M10 DX	M10 SX

TABELLA APPLICAZIONE SCOOTER

Aprilia	M8 DX	M8 DX - SX
Cagiva	M8 DX	M8 DX - SX
Honda	M8 DX	M8 DX
Suzuki	M8 DX	M8 DX
Piaggio	M8 DX	M8 DX
Yamaha	M8 DX	M8 SX

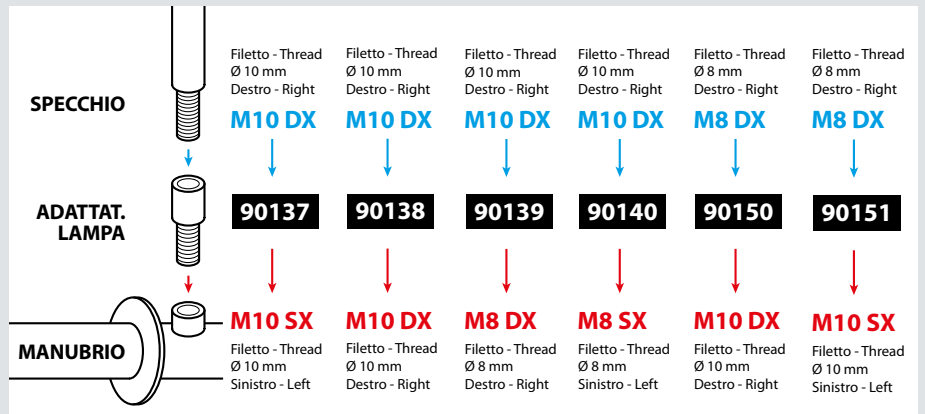



Manopole universali per moto, scooter e quad con impugnatura standard
 Universal grips for motorcycle, scooters and quads with standard hand grips



Tatoo

90293

D/Blister 5 / 50

GOMMA + ALLUMINIO



Soft Grip

90306

D/Blister 5 / 50



Road-Grip

90308

D/Blister 5 / 50



Off-Road

90307

D/Blister 5 / 50

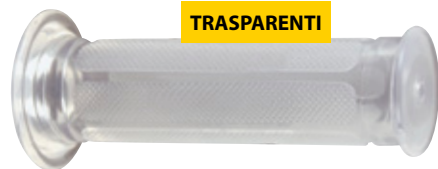

TRASPARENTI

X-Type

90304

D/Blister 5 / 50



G-Pulse

90294 Giallo Yellow

90298 Verde Green

D/Blister 5 / 50



GOMMA + ALLUMINIO

Metal-Grips

90309 Blu Blue

90310 Oro Gold

90311 Rosso Red

90312 Aluminium

D/Blister 5 / 50

Cruising

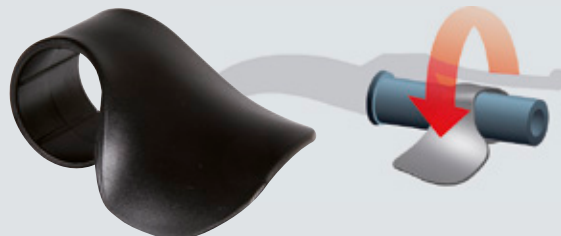

CRUISING, LEVA RIPOSA POLSO PER ACCELERATORE
 Permette di mantenere una velocità costante lasciando il polso in posizione di riposo. Aiuta a ridurre l'affaticamento durante i viaggi e i lunghi percorsi. Universale. Facile da installare e da utilizzare

CRUISING, ANTI-FATIGUE THROTTLE ASSIST
 Helps to maintain constant speed while resting your wrist

90073

D/Blister 5 / 50

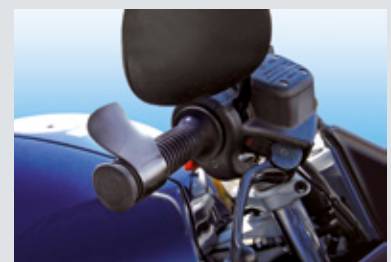



Toor

Ø 17÷23 mm

90242	Blu	Blue
90243	Oro	Gold
90244	Rosso	Red
90245	Aluminium	

D/Blister 5 / 50



SU-3

Ø 13÷17 mm

90318	Blu	Blue
90319	Oro	Gold
90320	Rosso	Red
90321	Aluminium	
90644	Nero	Black

D/Blister 5 / 50



SU-4

Ø 17÷23 mm

90322	Blu	Blue
90323	Oro	Gold
90324	Rosso	Red
90325	Aluminium	

D/Blister 5 / 50



SU-13

Ø 17÷23 mm

90313	Aluminium
-------	-----------

D/Blister 5 / 50



SU-14

Ø 17÷23 mm

90314	Carbon
-------	--------

D/Blister 5 / 50



SU-15

Ø 17÷23 mm

90315	Rosso	Red
-------	-------	-----

D/Blister 5 / 50



SU-2

Ø 17÷23 mm

90317	Nero	Black
-------	------	-------

D/Blister 5 / 50

COPPIA STABILIZZATORI MANUBRIO
Migliorano la stabilità della moto e riducono le vibrazioni sul manubrio
UNIVERSAL BAR ENDS (2 PCS)
Improve the stability of the motorcycle and reduce vibrations on the handlebar



Il diametro indicato è riferito alla sezione del manubrio
The specified diameter is referred to the handlebar section



* La funzione "Luce di Posizione" non è omologata per uso stradale.
* Position light is not approved on public roads.



STABILIZZATORI MANUBRIO CON LED, 12V

Aumentano la visibilità della moto. Riducono le vibrazioni sul manubrio. Per manubri con foro da Ø 17 a 23 mm

LED-LIGHTED BAR ENDS, 12V
Improve the motorcycle visibility. Reduce handlebar vibrations. Ø 17 / 23 mm fitting

90240	Nero	Black
90241	Carbon	Carbon

D/Blister 5 / 50



BLUE-WINGS, STABILIZZATORI ILLUMINATI, 12V
In lega di alluminio, terminale illuminato a led blu. Per manubri con fori da Ø 17 a 23 mm.

BLUE-WINGS, BLUE LIGHTED BAR ENDS, 12V
Aluminium. Long life Led, simple 2 wire connections. Ø 17 / 23 mm fitting.

90316	
-------	--

D/Blister 5 / 50



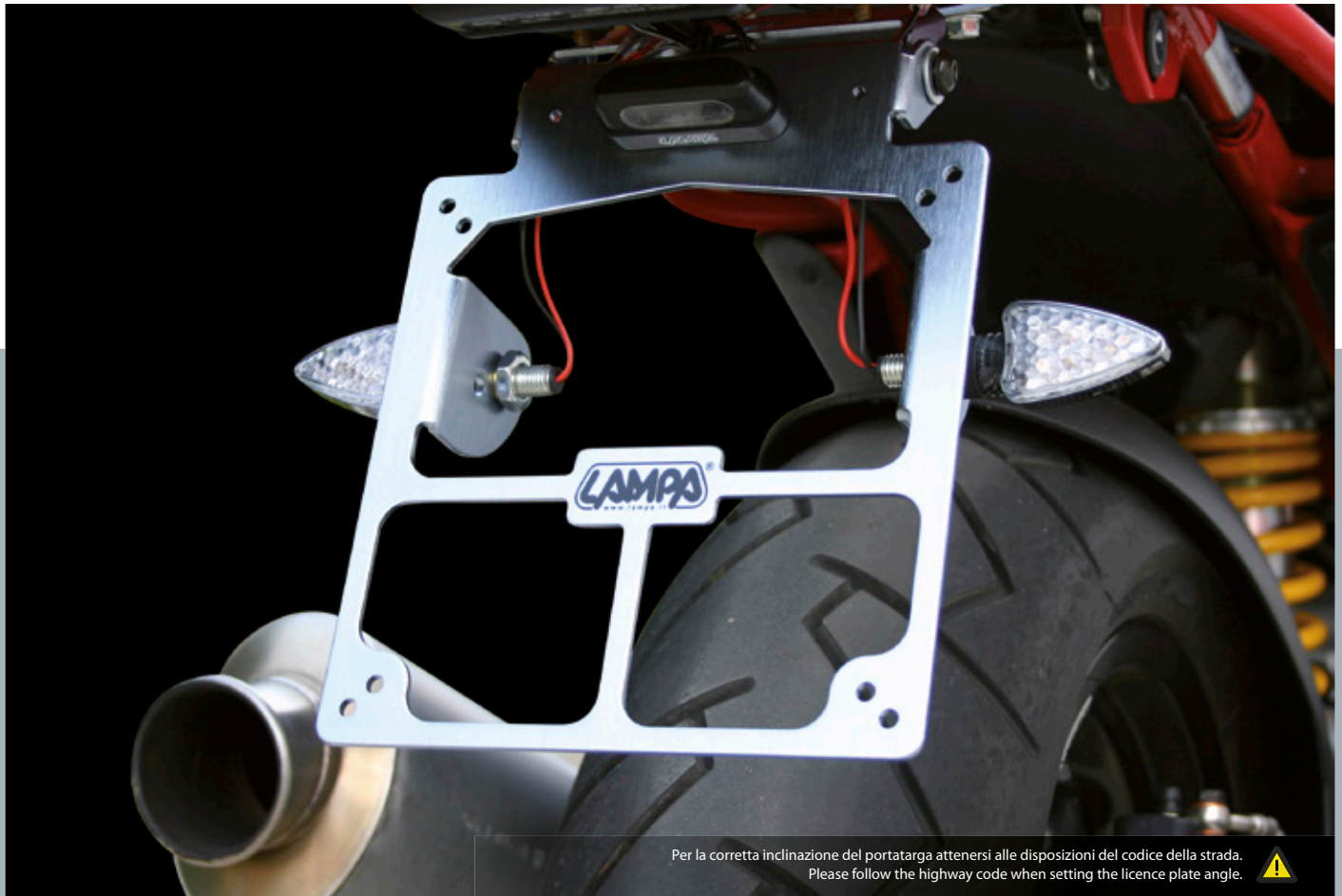

Per la corretta inclinazione del portatarga attenersi alle disposizioni del codice della strada.
Please follow the highway code when setting the licence plate angle.

X-Treme

XTREME, PORTATARGA UNIVERSALE
In alluminio. Regolazione inclinazione targa.
Fori per fissaggio frecce e luce targa.

XTREME, UNIVERSAL LICENCE PLATE HOLDER
Alloy made. Adjustable inclination number plate.
Holes for fixing corner lights and light plate.

90142	Aluminium
90153	Nero Black

D/Blister 5 / 20

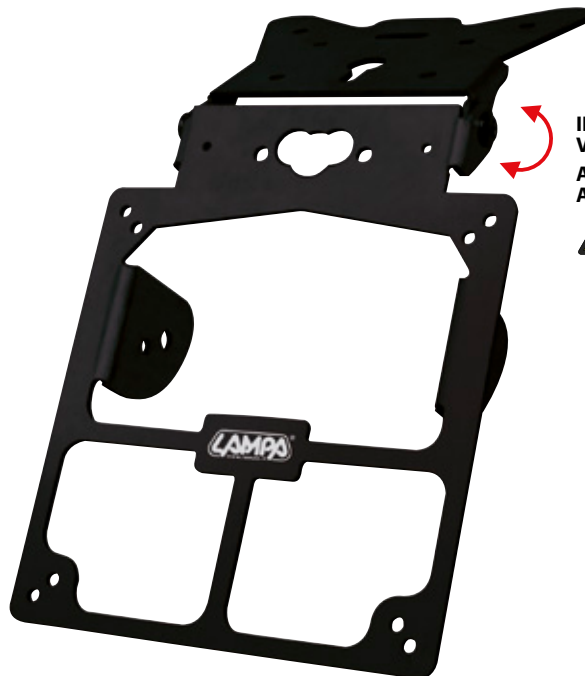

**INCLINAZIONE
VARIABILE
ADJUSTABLE
ANGLE**

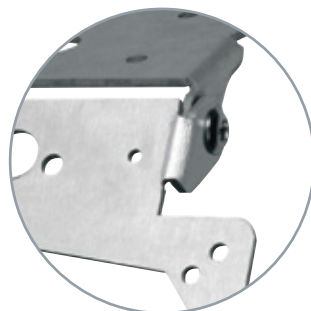
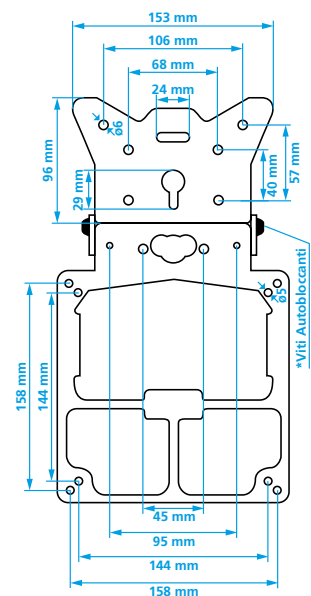

X-Plate

INCLINAZIONE
VARIABLE
ADJUSTABLE
ANGLE



X-PLATE, PORTATARGA

Alluminio anodizzato. Inclinazione regolabile.
Peso 250 grammi. Predisposizione per frecce e luce targa.

X-PLATE, LICENCE PLATE HOLDER

Aluminium material. Adjustable angle.
Weight 250 grams. Ready-made for corner lights and licence plate lamp.

90144 Nero Black

D/Blister 5 / 20

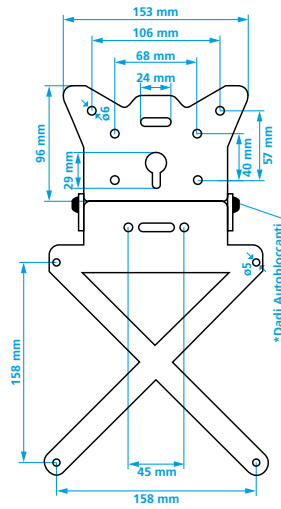

INCLINAZIONE
VARIABLE
ADJUSTABLE
ANGLE

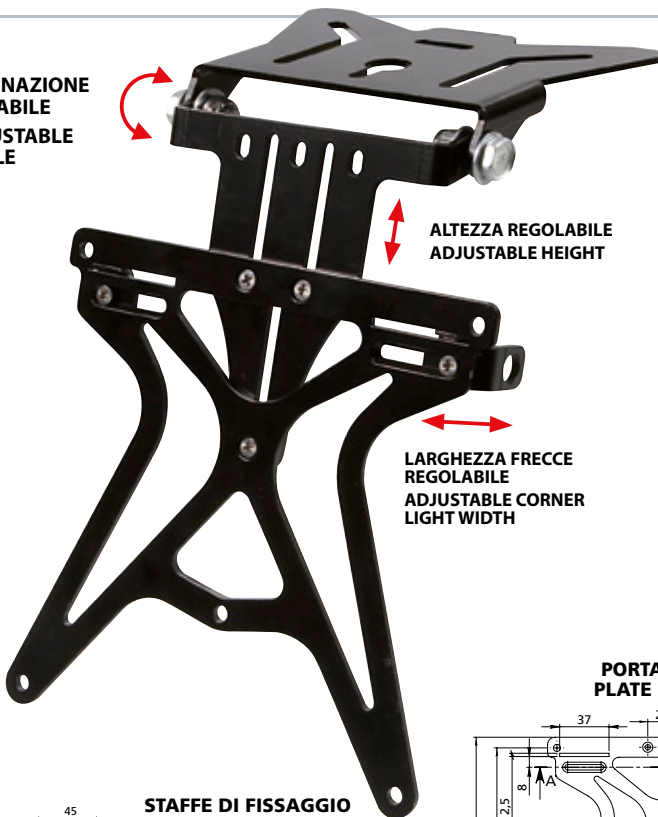

ALTEZZA REGOLABILE
ADJUSTABLE HEIGHT

LARGHEZZA FRECCIE
REGOLABILE
ADJUSTABLE CORNER
LIGHT WIDTH

Aero-X

AERO-X, PORTATARGA

COMPLETAMENTE REGOLABILE

Attacco sottocodone piatto.
Finitura a polvere epossidica.
Regolazione altezza, larghezza ed inclinazione.
Regolazione escursione frecce.
Predisposizione luce targa

AERO-X, FULLY ADJUSTABLE LICENCE PLATE HOLDER

Aluminium material. Adjustable angle.
Weight 250 grams. Ready-made for corner lights and licence plate lamp.

90146 Nero Black

D/Blister 5 / 50

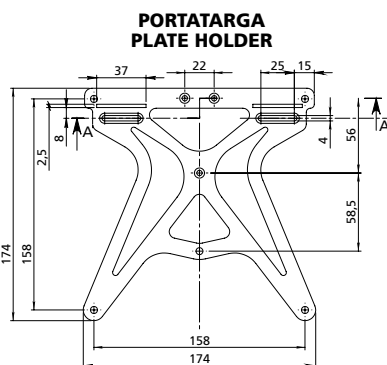
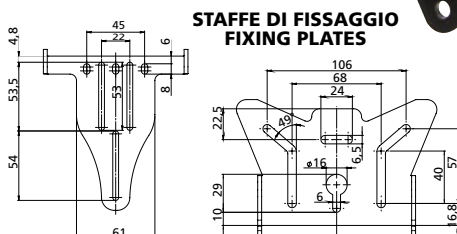



PORTATARGA UNIVERSALE MOTO
UNIVERSAL MOTORCYCLE LICENCE HOLDER

90143 188x208 mm

Sfuso / Bulk 5



PORTA TARGA IN ACCIAIO INOX
MOTORCYCLE LICENCE PLATE HOLDER
Stainless steel

90147 Cromo 185x185 mm
90148 Nero

Busta / Bag 10 / 50



ACCIAIO INOX
STAINLESS STEEL

CORNICE TARGA IN ACCIAIO INOX
MOTORCYCLE LICENCE PLATE FRAME
Stainless steel

90149 185x185 mm

Busta / Bag 10 / 50

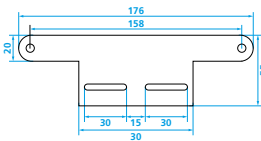

SUPPORTO PER CATARIFRANGENTE TARGA
In alluminio anodizzato. Asole di fissaggio.

REFLECTOR HOLDER
Aluminium material. Fitting loops.

90145

D/Blister 10 / 50



SET 100 BOTTONCINI
Per il fissaggio della targa sul portatarga. Idonei per tutti i portatarga Lampa

SET 100 PCS SMALL BUTTONS

19914 Bianco White
19915 Azzurro Light blue

Busta / Bag 100 / 1000



ACCIAIO
STEEL

CORNICE TARGA MOTO IN ACCIAIO

Verniciatura a polvere nera

STEEL MOTORCYCLE LICENCE PLATE FRAME
Black powder painting

90481 Nero Black 185x185 mm

Busta / Bag 10 / 50



PORTATARGA UNIVERSALE PER CICLOMOTORI

Con omologazione al trasporto di un passeggero.

UNIVERSAL SCOOTER LICENCE HOLDER

90141 150x155 mm

Sfuso / Bulk 5

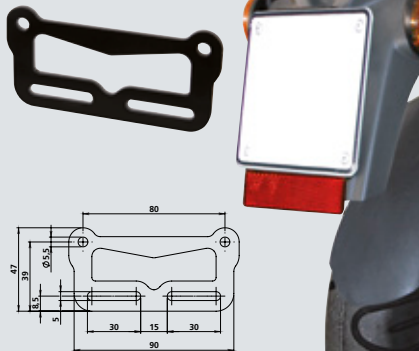

SUPPORTO PER CATARIFRANGENTE TARGA CICLOMOTORI

In alluminio. Finitura a polvere epossidica. Peso 20 g

REFLECTOR HOLDER
Made of aluminium. Black epoxy coated. Weight 20 g

90189

D/Blister 10 / 50

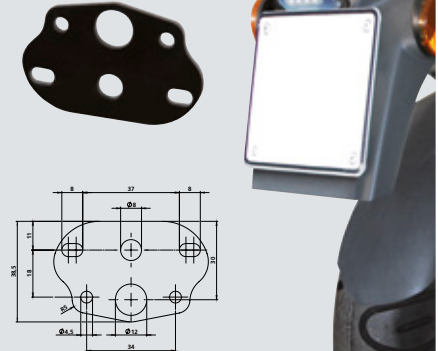

SUPPORTO LUCE TARGA PER CICLOMOTORI

In alluminio. Peso 13 g
Finitura a polvere epossidica.

REFLECTOR HOLDER FOR MOPEDS
Made of aluminium. Weight 13 g
Black epoxy coated.

90190

D/Blister 10 / 50

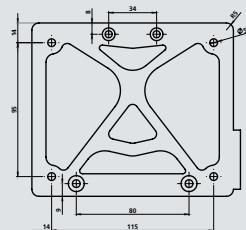

**KUOX, PORTATARGA
LATERALE**
In alluminio. Peso 85 g.
Finitura a polvere epossidica.
Predisposizione per luce targa

**KUOX, SIDE LICENCE PLATE
HOLDER FOR MOPEDS**
Made of aluminium.
Weight 85 g.
Black epoxy coated.
Ready made for plate light

90185

D/Blister 10 / 50

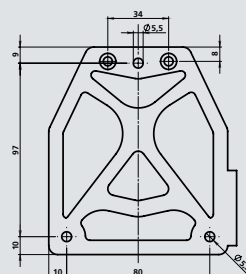

**NAXOX, PORTATARGA
LATERALE PER CICLAMOTORI**
In alluminio. Peso 60 g.
Finitura a polvere epossidica.
Predisposizione per luce targa

**NAXOX, SIDE LICENCE PLATE
HOLDER FOR MOPEDS**
Made of aluminium.
Weight 60 g.
Black epoxy coated.
Ready made for plate light

90186

D/Blister 10 / 50

INCLINAZIONE
VARIABILE
ADJUSTABLE
ANGLE

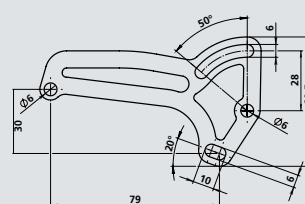
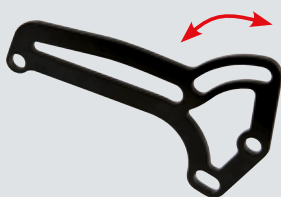

**SUPPORTO PER TARGA
LATERALE IDONEO PER
BLOCCO MOTORE PIAGGIO**
In alluminio.
Finitura a polvere epossidica.
Peso 15 g

**SIDE LICENCE PLATED
HOLDER FOR SCOOTERS
WITH PIAGGIO ENGINE**
Made of aluminium.
Black epoxy coated.
Weight 15 g

90187

D/Blister 10 / 50

INCLINAZIONE
VARIABILE
ADJUSTABLE
ANGLE

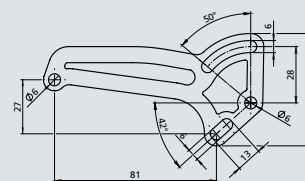
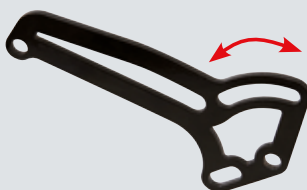

**SUPPORTO PER TARGA
LATERALE IDONEO PER
BLOCCO MOTORE MINARELLI**
In alluminio.
Finitura a polvere epossidica.
Peso 15 g

**SIDE LICENCE PLATED
HOLDER FOR SCOOTERS
WITH MINARELLI ENGINE**
Made of aluminium.
Black epoxy coated.
Weight 15 g

90188

D/Blister 10 / 50



Pro-Tank

PROTEZIONI ADESIVE PER SERBATOIO

Si applicano in pochi secondi.
 Proteggono il serbatoio dai graffi causati dallo sfregamento di cinture, cerniere o bottoni. Impermeabili ed anti UV.

ADHESIVE TANK PADS

Easy mounting. Protects the tank from scratches normally caused by belts, zips, button. Water and UV-proofs.

Blister 10 / 100

Pro-Tank x1

90010	Carbon
90094	Nero Black

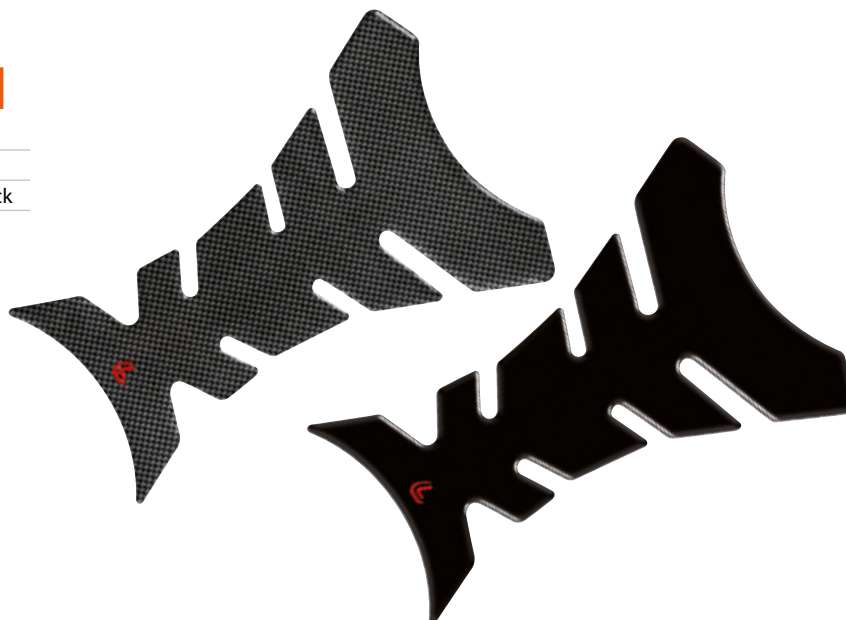
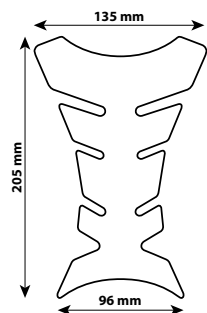

Pro-Tank x2

90510	Carbon
90511	Nero Black

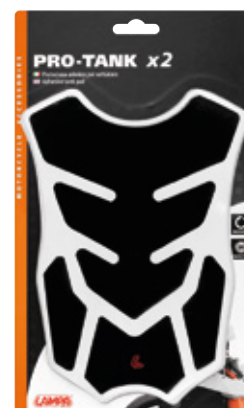
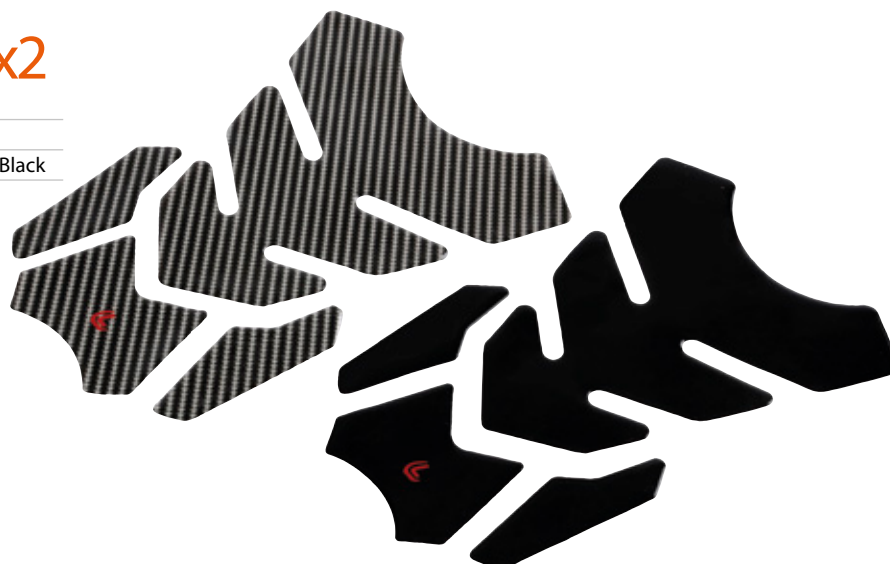
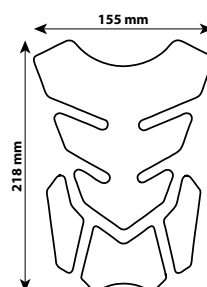

Pro-Tank x3

90512	Carbon
90513	Nero Black

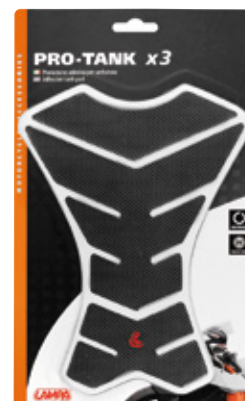
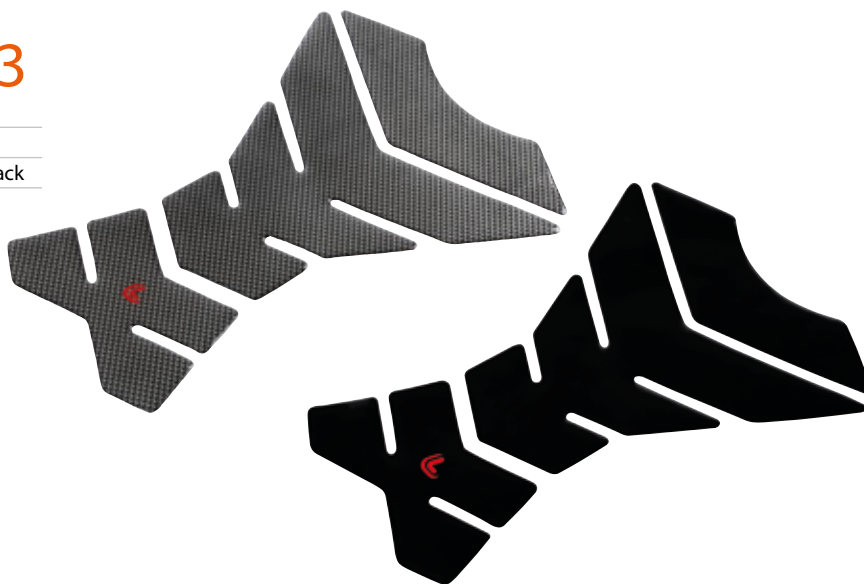
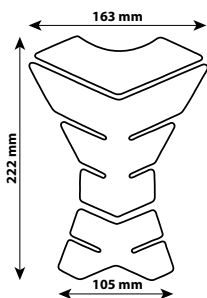

Pro-Tank x4

90514	Carbon
90515	Nero Black

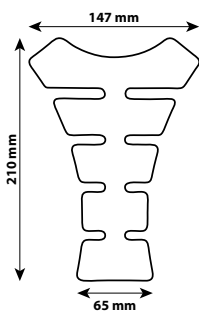

Pro-Tank x5

90516	Carbon
90517	Nero Black

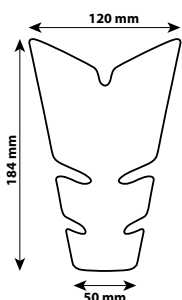

3D Carbon look



2 pcs SET



Grip-Tank x1

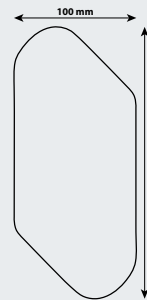

GRIP-TANK X1, PROTEZIONI ADESIVE PER SERBATOIO

- Si applica in pochi secondi.
- Protegge il serbatoio dai graffi causati dallo sfregamento delle gambe.
- Aiuta a ridurre l'affaticamento durante le frenate.

GRIP-TANK X1, ADHESIVE TANK PADS

Easy mounting. Protects the tank from scratches and scuffs caused by rubbing the legs against the body. Helps reduce fatigue during braking.

90508	Nero	Black
90509	Trasparente	Clear

Blister 10 / 100



COPERTURA TAPPO CARBURANTE

Si applica in pochi secondi. Impermeabile e anti-UV.

FUEL CAP COVER

Easy mounting. Water and uv-proof.

D/Blister 5 / 25

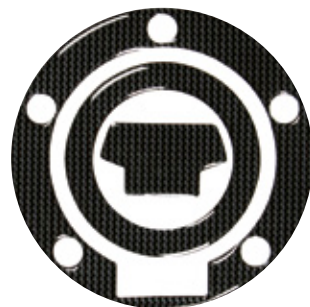

90004 5 fori / holes

Yamaha

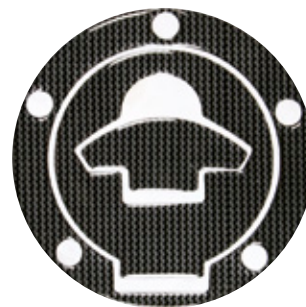

90007 5 fori / holes

Ducati

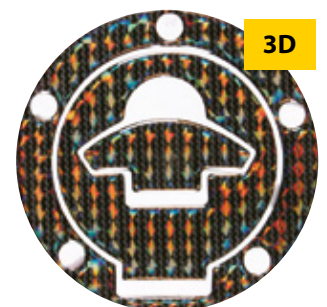

3D

90008 5 fori / holes

Ducati

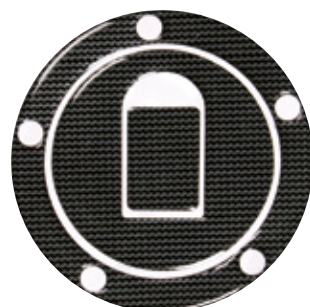

90003 5 fori / holes

Kawasaki
Suzuki

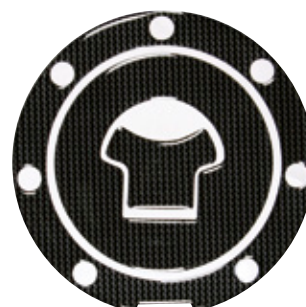

90005 7 fori / holes

Honda

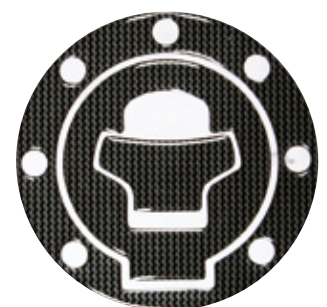

90009 7 fori / holes

Suzuki



Adatta anche per superfici ruvide
Ok for rough surfaces

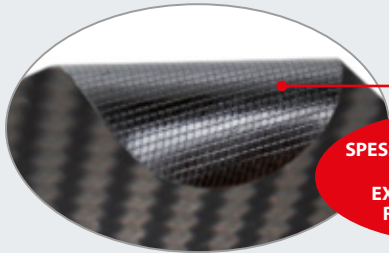

Micro-scanalature
Air-Release Channels

SPESSORE MAGGIORATO CON RILIEVO
EXTRA THICK REAL RELIEF PATTERN

SUPER-TECH, PELLICOLA ADESIVA CARBON-LOOK 3D

- Facile da applicare, senza formazione di bolle d'aria, grazie alle speciali micro-scanalature.
- Adesivo speciale per applicazione sia su superfici lisce che ruvide, all'interno oppure all'esterno.
- Può essere facilmente rimossa e riapplicata.
- Speciale per interni auto come cruscotto, plancia, inserti portiere...
- Flessibile e termo-formabile con phon, può essere scaldata e modellata per l'applicazione su superfici curve senza lasciare pieghe.

SUPER-TECH, 3D CARBON-LOOK FILM

- Can be applied to any surface, such as car, computers, phones...
- Easy to apply, without air-bubble thanks to the special air-release channels.
- Sticks onto smooth and rough surfaces, indoor or outdoor use.
- Removable and flexible for curves

02965	50x75 cm
02966	50x150 cm

Scatola / Box 50

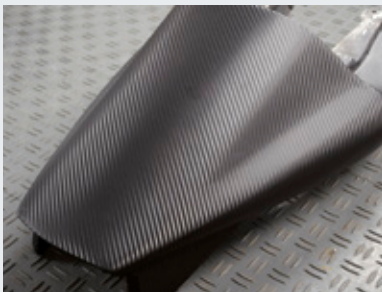

GHOST, PELLICOLA PROTETTIVA ADESIVA

In PVC, protegge la superficie dai graffi. Ideale per cupolini, serbatoi, carene, telai.

GHOST, ADHESIVE PROTECTIVE FILM

PVC material, protects surfaces against scratches. For fairing, frame and tank.

90040	Trasparente Clear	50x50 cm
--------------	-------------------	-----------------

Scatola / Box 6 / 36



PVC

Ghost



3D LETTERS - CONFEZIONE SINGOLA

Lettere, numeri e simboli adesivi prodotti in plastica a rilievo con cromatura a specchio. Retro con adesivo speciale per comporre ed applicare nomi, frasi o testi su qualsiasi superficie liscia

3D LETTERS - SINGLE PACK

Adhesive chromed letters, numbers and symbols

Busta / Bag 10 / 250



3D Letters

3D LETTERS - ESPOSITORE DA 480 PEZZI

In plastica a rilievo con cromatura a specchio. Retro con adesivo speciale 48 caratteri assortiti per 10 pezzi

3D LETTERS - 480 PCS WALL-DISPLAY

Chromed relief plastic letters, with special adhesive 48 characters x 10 pcs each

07910	Type-1	
07060	Type-2	480 pz (48 caratteri x 10 pz)
07860	Type-3	

Scatola / Box 5

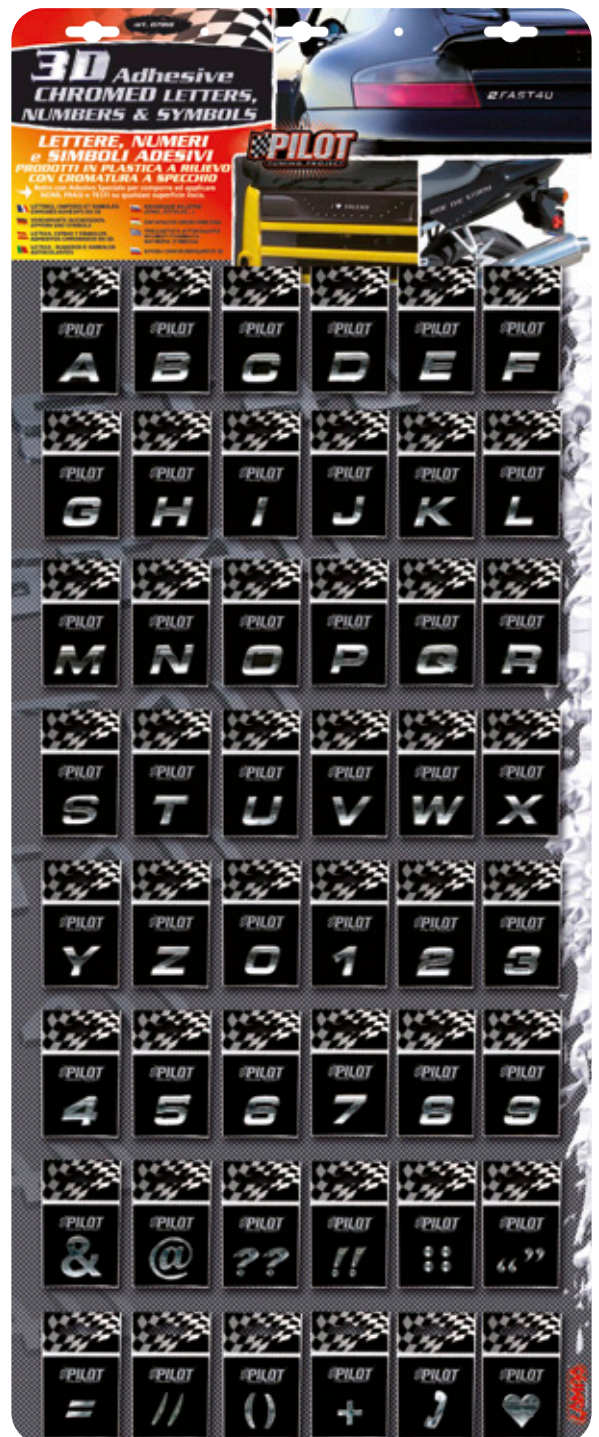

	Type 1	Type 2	Type 3
A	07911	07061	07861
B	07912	07062	07862
C	07913	07063	07863
D	07914	07064	07864
E	07915	07065	07865
F	07916	07066	07866
G	07917	07067	07867
H	07918	07068	07868
I	07919	07069	07869
J	07920	07070	07870
K	07921	07071	07871
L	07922	07072	07872
M	07923	07073	07873
N	07924	07074	07874
O	07925	07075	07875
P	07926	07076	07876
Q	07927	07077	07877
R	07928	07078	07878
S	07929	07079	07879
T	07930	07080	07880
U	07931	07081	07881
V	07932	07082	07882
W	07933	07083	07883
X	07934	07084	07884
Y	07935	07085	07885
Z	07936	07086	07886

	Type 1	Type 2	Type 3
0	07937	07087	07887
1	07938	07088	07888
2	07939	07089	07889
3	07940	07090	07890
4	07941	07091	07891
5	07942	07092	07892
6	07943	07093	07893
7	07944	07094	07894
8	07945	07095	07895
9	07946	07096	07896
&	07947	07097	07897
@	07948	07098	07898
??	07949	07099	-
!!	07950	07100	07900
::	07951	07101	07901
""	07952	07102	-
--	07953	07103	-
//	07954	-	07904
()	07955	07105	07905
+	07956	07106	07906
∫	07957	-	07907
♥	07958	07108	07908

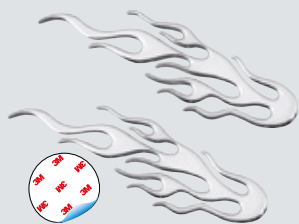

EMBLEMA 3D CROMATO
Base adesiva speciale.
Trattamento speciale al cromo
CHROMED 3D EMBLEM

15025 2 x cm 13

D/Blister 10 / 100

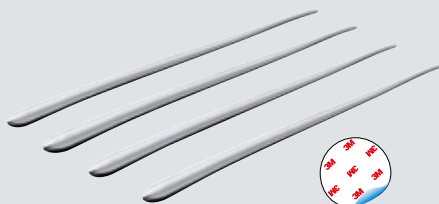

MIRROR-TRIMS 4, DECORAZIONI ADESIVE CROMATE, 4 PZ
Flessibili, per adattarsi meglio alle curvature. Adesivo speciale

MIRROR-TRIMS 4, CHROMED ADHESIVE DECORATIONS, 4 PCS
May be curved to fit everywhere.
Special ultra-strong adhesive

20830 170 mm

D/Blister 10 / 100



PENNARELLO PER PNEUMATICI
Vernice ad alta copertura. Resistente all'acqua ed agli agenti atmosferici.

TYRE PAINT PEN
High resistant instant dry paint marker

74101 Bianco White

74102 Argento Silver

D/Blister 10 / 200



Spell-It

SPELL-IT, LETTERE E NUMERI ADESIVI
Lettere 15x10 mm, numeri 140x65 mm.

SPELL-IT, ADHESIVE CHARACTERS AND NUMBERS
Characters 15x10 mm,
numbers 140x65 mm.



**CONFEZIONI SINGOLE
SINGLE PACKS**

Busta / Bag 10 / 500

BIANCO WHITE	NERO BLACK	
90371	-	1
90372	90383	2
90373	90384	3
90374	90385	4
90375	90386	5
90376	-	6
90377	-	7
90378	-	8
90379	90390	9
90380	-	0
90392	90393	Kit lettere

**Con applicatore
With dispenser**

PROFILO RIFLETTENTE ADESIVO
Kit per 2 cerchi. Universali.
Altezza 5 mm. Lunghezza 750 cm.
Applicatore incluso

REFLECTIVE ADHESIVE TRIM
Kit for 2 rims. Universal fit.
Height 5 mm. Total length 750 cm.
Dispenser included

90041	Rosso	Red
90042	Verde	Green
90043	Bianco	White
90044	Giallo	Yellow
90045	Arancio	Amber
90046	Argento	Silver
90047	Blu	Blue

D/Blister 10 / 80

RIM-STICKERS, PROFILI ADESIVI RUOTA

- Pre-sagomati, pronti per una facile applicazione senza pieghe o grinze.
- Materiale plastico ed adesivo specifici per uso esterno.
- Semplice da applicare e di grande effetto visivo.

RIM-STICKERS

- Pre-cut, ready for an easy and simple application without creases or wrinkles.
- Special Plastic material and adhesive for exterior use.
- Standout in the crowd

D/Blister 10 / 100

Rim-Stickers

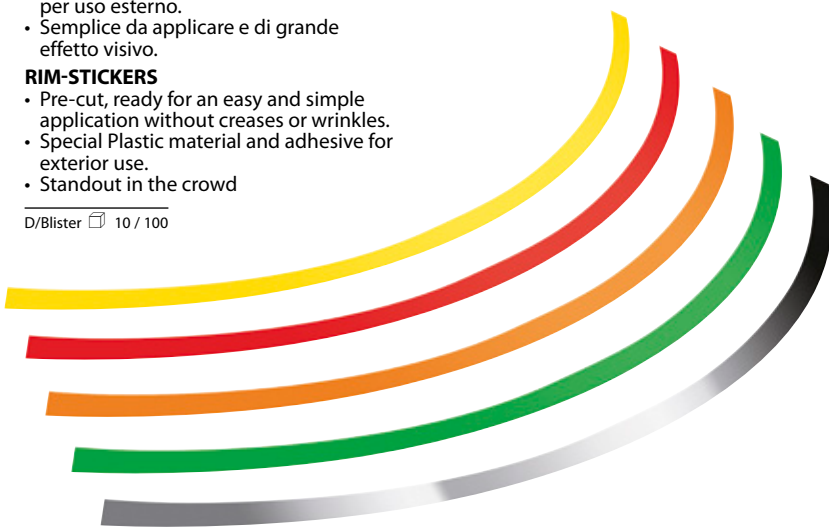

SIZE 1
14" - 15"
16"



SIZE 2
17" - 18"
19" - 20"

PER CERCHI FOR WHEELS **14" - 15" - 16"**

30780	Cromo	Chrome	SIZE 1
30781	Verde	Green	
30782	Arancio	Orange	
30783	Rosso	Red	
30784	Giallo	Yellow	

PER CERCHI FOR WHEELS **17" - 18" - 19" - 20"**

30785	Cromo	Chrome	SIZE 2
30786	Verde	Green	
30787	Arancio	Orange	
30788	Rosso	Red	
30789	Giallo	Yellow	

